

REV.	Description	REV.	Description
00	首次发行		
	种梦雪 2024/04/26		
00	1. 红色系统开关指示灯描述时写指示灯亮起, 不加颜色 2. 更新 UI 界面		
	种梦雪 2024/06/07		
01	1. 更新机器裸机与整机重量 2. 删除巴西认证 INMETRO; 修改 Safety 3. 逆变器拓扑改为 Non-isolated 4. 删除质保年限 5. 技术参数修改: Peak apparent power ; Switching time ; Cooling concept; Humidity		
	种梦雪 2024/07/10		
02	1. 修改 CT 连接 2. 修改故障列表 3. 增加并机内容		
	种梦雪 2024/11/22		
02	增加内置 RCMU 说明、修改安装环境图示等安规优化项 删除 RCM 标识解释 修改工作模式描述 修改指示灯说明, 增加自定义安规说明、偏取电说明、修改锂电设置项、更新部分设置等 增加发电机内容 更新故障列表部分内容 其他细节修改		
	曾翠兰 2024/12/09-2025/01/13		
02	增加锂电做铅酸使用的免责声明		
	种梦雪 2025/03/06		
描述	说明书 X1-Lite-LV 系列 英文版 SolaX 02 版	浙江艾罗网络能源技术股份有限公司 SolaX Power Network Technology (Zhejiang) Co., Ltd.	
料号	320101105802		
单位	mm 页次		



X1-Lite-LV

8 kW / 10 kW / 12 kW

**User Manual**

Version 2.0

[www.solaxpower.com](http://www.solaxpower.com)

**技术要求:**

- 封面封底 157g 铜版纸覆哑膜彩打, 内部纸 80g 双胶纸黑白印刷, 正反打印;
- 装订方式: 胶装或骑马钉, 内页大于 60 页时须胶装;
- 未注尺寸公差按  $\pm 3$  mm;
- 图面、字体印刷清晰、无偏移、无毛边、不起边、油墨不脱落;
- 黑色字体颜色为 PANTONE BLACK C, 无边框, 底色为白色;
- 符合 ROHS 要求。

描述	说明书 X1-Lite-LV 系列 英文版 SolaX 02 版	设计	种梦雪 曾翠兰 2025/01/13
		审核	侯坚 2025/01/13
材料	双胶纸	核准	施鑫淼 2025/01/13
料号	320101105802	浙江艾罗网络能源技术股份有限公司	
单位	mm 页次		

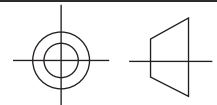
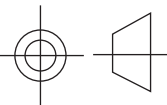







# X1-Lite-LV

8 kW / 10 kW / 12 kW

## User Manual

Version 2.0

[www.solaxpower.com](http://www.solaxpower.com)



eManual in the QR code or  
at <http://ks.solaxpower.com/>



# STATEMENT

---

## Copyright

Copyright © SolaX Power Network Technology (Zhejiang) Co., Ltd. All rights reserved.

No part of this manual may be reproduced, transmitted, transcribed, stored in a retrieval system, or translated into any language or computer language, in any form or by any means without the prior written permission of SolaX Power Network Technology (Zhejiang) Co., Ltd.

## Trademarks



SOLA X and other symbol or design (brand name, logo) that distinguishes the products or services offered by SolaX has been trademark protected. Any unauthorized use of the above stated trademark may infringe the trademark right.

## Notice

Please note that certain products, features, and services mentioned in this document may not be within the scope of your purchase or usage. Unless otherwise specified in the contract, the contents, information, and recommendations presented in this document are provided "as is" by SolaX. We do not provide any warranties, guarantees, or representations, whether express or implied.

The content of the documents is reviewed and updated as needed. However, occasional discrepancies may occur. SolaX retains the right to make improvements or changes in the product(s) and the program(s) described in this manual at any time without prior notice.

The images included in this document are solely for illustrative purposes and may differ based on the specific product models.

For more detailed information, kindly visit the website of SolaX Power Network Technology (Zhejiang) Co., Ltd. at [www.solaxpower.com](http://www.solaxpower.com).

SolaX retains all rights for the final explanation.

# About This Manual

---

## Scope of Validity

This manual is an integral part of X1-Lite-LV series inverter. It describes the transportation, storage, installation, electrical connection, commissioning, maintenance and troubleshooting of the product. Please read it carefully before operating.

This manual is valid for the following inverter models:

- X1-Lite-8K-LV
- X1-Lite-10K-LV
- X1-Lite-12K-LV

### Model description

# X1-Lite-8K-LV

1

2

3

Item	Meaning	Description
1	Product family name	"X1-Lite": energy storage series inverter that supports grid connection of photovoltaic system;
2	Power	"8K": rated output power of 8 kW.
3	Low voltage battery	"LV" means the inverter should pair with low voltage battery.



## Target Group

The installation, maintenance and grid-related setting can only be performed by qualified personnel who:

- Are licensed and/or satisfy state and local regulations.
- Have good knowledge of this manual and other related documents.

## Conventions

The symbols that may be found in this manual are defined as follows.

Symbol	Description
 <b>DANGER</b>	Indicates a hazardous situation which, if not avoided, will result in death or serious injury.
 <b>WARNING</b>	Indicates a hazardous situation which, if not avoided, could result in death or serious injury.
 <b>CAUTION!</b>	Indicates a hazardous situation which, if not avoided, could result in minor or moderate injury.
<b>NOTICE!</b>	Provides tips for the optimal operation of the product.

## Change History

### Version 2.0 (2025-01-13)

Updated "[2.7 Working Mode](#)" (Updated the descriptions about working modes)

Updated "[5.1.1 Environment Requirement](#)" (Updated the contents)

Updated "[10 Operation on LCD](#)" (Updated the descriptions of the LED indicators and the setting contents)

Updated "[12.2 Troubleshooting](#)" (Updated the troubleshooting list)

Added "[15 Appendix](#)" (Added contents about parallel function and generator)

### Version 1.0 (2024-07-20)

Updated "[14 Technical Data](#)"

### Version 0.0 (2024-06-20)

Initial release

# Table of Contents

---

<b>1</b>	<b>Safety</b> .....	<b>1</b>
1.1	General Safety .....	1
1.2	Safety Instructions of PV, Inverter, Grid and Battery .....	2
1.2.1	Safety Instructions of PV .....	2
1.2.2	Safety Instructions of Inverter .....	3
1.2.3	Safety Instructions of Utility Grid .....	4
1.2.4	Safety Instructions of Battery .....	4
<b>2</b>	<b>Product Overview</b> .....	<b>5</b>
2.1	Product Introduction .....	5
2.2	Appearance .....	5
2.3	Supported Power Grid .....	6
2.4	Symbols on the Label and Inverter .....	7
2.5	Working Principle .....	8
2.5.1	Circuit Diagram .....	8
2.5.2	Application Schemes .....	9
2.6	Working State .....	9
2.7	Working Mode .....	10
2.7.1	SUB Mode (Pakistan) .....	10
2.7.2	SBU Mode (Pakistan) .....	11
2.7.3	MKS/EPS Mode (Pakistan) .....	12
2.7.4	Force Time Use Mode (Pakistan) .....	13
2.7.5	Back Up Mode (Other Countries) .....	14
2.7.6	Self Consumption Mode (Other Countries) .....	15
2.7.7	Force Time Use Mode (Other Countries) .....	17
<b>3</b>	<b>System Overview</b> .....	<b>18</b>
<b>4</b>	<b>Transportation and Storage</b> .....	<b>20</b>
<b>5</b>	<b>Preparation before Installation</b> .....	<b>21</b>
5.1	Selection of Installation Location .....	21
5.1.1	Environment Requirement .....	21
5.1.2	Installation Carrier Requirement .....	23
5.1.3	Clearance Requirement .....	23
5.2	Tools Requirement .....	25
5.3	Additionally Required Materials .....	26

- 6 Unpacking and Inspection ..... 28**
  - 6.1 Unpacking.....28
  - 6.2 Scope of Delivery.....29
- 7 Mechanical Installation ..... 31**
  - 7.1 Dimensions for mounting.....32
  - 7.2 Installation procedures.....33
- 8 Electrical Connection ..... 36**
  - 8.1 Terminals of Inverter .....37
  - 8.2 PE Connection .....38
  - 8.3 EPS, GEN and GRID Connection .....40
  - 8.4 PV Connection .....47
  - 8.5 Battery Power Cable Connection.....51
  - 8.6 COM Communication Connection .....57
    - 8.6.1 Pin Assignment of COM Terminal.....57
    - 8.6.2 DI/COM Connection.....58
    - 8.6.3 DO Connection .....59
    - 8.6.4 BMS Communication Connection .....59
    - 8.6.5 DRM Connection (Applicable to AS/NZS 4777.2) .....59
    - 8.6.6 Meter/CT Connection.....60
    - 8.6.7 Parallel Connection.....63
    - 8.6.8 Wiring procedure of COM Communication Connection .....64
  - 8.7 Monitoring Connection .....72
- 9 System Commissioning ..... 75**
  - 9.1 Checking before Power-on .....75
  - 9.2 Powering on the System.....75
- 10 Operation on LCD..... 77**
  - 10.1 Introduction of Control Panel.....77
  - 10.2 Introduction of Menu Interface.....79
  - 10.3 Work Mode .....82
  - 10.4 Export Control.....86
  - 10.5 Battery Setting .....86
  - 10.6 About.....88
  - 10.7 Smart Load.....89
  - 10.8 Setting .....90
    - 10.8.1 Basic Setting.....90
    - 10.8.2 Advanced Setting .....92
  - 10.9 History Errors .....98

- 10.10 Parallel Setting .....98
- 11 Operation on SolaX App and Web..... 99**
  - 11.1 Introduction of SolaXCloud..... 99
  - 11.2 Operation Guide on SolaXCloud App ..... 99
    - 11.2.1 Downloading and Installing App ..... 99
    - 11.2.2 Operations on App ..... 99
  - 11.3 Operations on SolaXCloud Webpage..... 99
- 12 Troubleshooting and Maintenance ..... 100**
  - 12.1 Power off..... 100
  - 12.2 Troubleshooting..... 100
  - 12.3 Maintenance..... 111
    - 12.3.1 Maintenance routines ..... 111
    - 12.3.2 Upgrading Firmware..... 112
- 13 Decommissioning..... 114**
  - 13.1 Disassembling the Inverter ..... 114
  - 13.2 Packing the Inverter ..... 116
  - 13.3 Disposing of the Inverter ..... 116
- 14 Technical Data ..... 117**
- 15 Appendix ..... 120**
  - 15.1 Application of Parallel Function ..... 120
    - 15.1.1 Introduction of Parallel Application..... 120
    - 15.1.2 Notice for Parallel Application..... 120
    - 15.1.3 System Wiring Diagram ..... 121
    - 15.1.4 System Wiring Procedure..... 122
    - 15.1.5 Settings for Parallel Connection..... 124
  - 15.2 Application of Generator..... 125
    - 15.2.1 Introduction of Generator Application ..... 125
    - 15.2.2 Notice for Generator Application ..... 125
    - 15.2.3 Dry Contact Mode..... 126



# 1 Safety

---

## 1.1 General Safety

The series inverter has been meticulously designed and thoroughly tested to comply with the relevant state and international safety standards. Nevertheless, like all electrical and electronic equipment, safety precautions must be observed and followed during the installation of the inverter to minimize the risk of personal injury and ensure a safe installation.

Please thoroughly read, comprehend, and strictly adhere to the comprehensive instructions provided in the user manual and any other relevant regulations prior to the installation of the inverter. The safety instructions in this document serve as supplementary guidelines to local laws and regulations.

SolaX shall not be liable for any consequences resulting from the violation of the storage, transportation, installation, and operation regulations outlined in this document. Such consequences include, but are not limited to:

- Inverter damage caused by force majeure events, such as earthquakes, floods, thunderstorms, lightning, fire hazards, volcanic eruptions, and similar events.
- Inverter damage due to human causes.
- Usage or operation of the inverter in violation of local policies or regulations.
- Failure to comply with the operation instructions and safety precautions provided with the product and in this document.
- Improper installation or usage of the inverter in unsuitable environmental or electrical conditions.
- Unauthorized modifications to the product or software.
- Inverter damage occurring during transportation by the customer.
- Storage conditions that do not meet the requirements specified in this document.
- Installation and commissioning performed by unauthorized personnel who lack the necessary licenses or do not comply with state and local regulations.

## 1.2 Safety Instructions of PV, Inverter, Grid and Battery

Save these important safety instructions. Failure to follow these safety instructions may result in damage to the inverter and injury or even loss of life.

### 1.2.1 Safety Instructions of PV

#### DANGER!

##### **Potential risk of lethal electric shock associated with the photovoltaic (PV) system**

- Exposure to sunlight can result in the generation of high DC voltage by PV modules, which can lead to electric shock causing severe injuries or even death.
- Never touch the positive or negative poles of the PV connecting device, and avoid touching both poles simultaneously.
- Do not ground the positive or negative poles of the PV modules.
- Only qualified personnel can perform the wiring of the PV modules.

#### WARNING!

- Overvoltage protection with surge arresters should be provided when the PV system is installed. The inverter is fitted with SPDs on both PV input side and MAINS side.
- Please consult professionals before installing SPDs.

#### WARNING!

- Make sure that the input DC voltage does not exceed the maximum DC input voltage specified for the inverter. Overvoltage can cause irreversible damage to the inverter, and such damage is not covered by the warranty.

#### WARNING!

- A photovoltaic module used on the inverter must have an IEC61730 class A rating, and the total open circuit voltage of the photovoltaic string / array is lower than the maximum rated DC input voltage of the inverter. Any damage caused by photovoltaic overvoltage is not covered by warranty.

## 1.2.2 Safety Instructions of Inverter

### DANGER!

#### Potential risk of lethal electric shock associated with the inverter

- Only operate the inverter if it is in a technically faultless condition. Operating a faulty inverter may lead to electric shock or fire.
- Unauthorized opening of the upper cover will void the warranty and can result in lethal danger or serious injury due to electric shock.
- Make sure that the inverter is reliably grounded before any operation to prevent the risk of electric shock causing lethal danger or serious injury.
- Only qualified personnel can perform the installation, wiring, maintenance of the inverter by following this document and the related regulations.

### WARNING!

- During operation, avoid touching any parts of the inverter other than the DC switch and LCD panel (if any).
- Never connect or disconnect the AC and DC connector while the inverter is running.
- Prior to conducting any maintenance, turn off the AC and DC power and disconnect them from the inverter. Wait for 5 minutes to fully discharge the energy.

### WARNING!

- The inverter can not be operated when it is running. Radiation may be harmful to health! Do not stay for a long time and keep at least 20 cm away from the inverter.
- After the inverter and power grid cut off the PV power supply, there will be a certain amount of residual voltage in a short time, be cautious or it may lead to serious personal injury and even high risk of death. Use a multimeter (impedance at least 1 M $\Omega$ ) to measure the voltage between the UDC and the UDC to ensure that the inverter port is discharged below the safe voltage before starting operation (35 VDC).

### WARNING!

#### Potential danger of scalding due to the hot enclosure of the inverter

- Avoid touching the inverter while it is running, as it becomes hot during operation and may cause personal injuries.

### WARNING!

- Use insulated tools when installing the device, and always wear personal protective equipment during installation and maintenance.

 CAUTION!

- Make sure that children are supervised to prevent them from playing with the inverter.
- Pay attention to the weight of the inverter and handle it properly to avoid personal injuries.

NOTICE!

- The inverter has an integrated Type-B Residual Current Monitoring Unit (RCMU). If an external Residual Current Device (RCD) is required by local regulations, verify the type of RCD required. It is recommended to use a Type-A RCD with a rating of 300 mA unless a lower value is required by the specific local electric codes. When required by local regulations, the use of an RCD type B is permitted.
- Keep all product labels and the nameplate on the inverter clearly visible and well-maintained.

### 1.2.3 Safety Instructions of Utility Grid

NOTICE!

- Only connect the inverter to the grid with the permission of the local utility grid company.

### 1.2.4 Safety Instructions of Battery

 WARNING!

- SolaX assumes no responsibility for any problems arising from the use of third-party lithium batteries connected as lead-acid batteries.
- Prohibit the use of SolaX lithium battery in Lead-acid mode. Any consequences arising from the use of lead-acid mode shall be borne by users themselves, and SolaX will not provide warranty!

 WARNING!

- When handling the battery, carefully follow all safety instructions provided in the battery manual. The battery used with the inverter must meet the specified requirements of the series inverter.

NOTICE!

- This inverter should pair with low voltage battery, for the specific parameters such as battery type, nominal voltage and nominal capacity etc., please refer to Battery Data. Refer to the matching battery specification for details.

## 2 Product Overview

### 2.1 Product Introduction

The X1-Lite-LV series inverter is an energy storage PV grid-connected inverter. It supports various intelligent solutions to achieve efficient and economical energy utilization.

### 2.2 Appearance

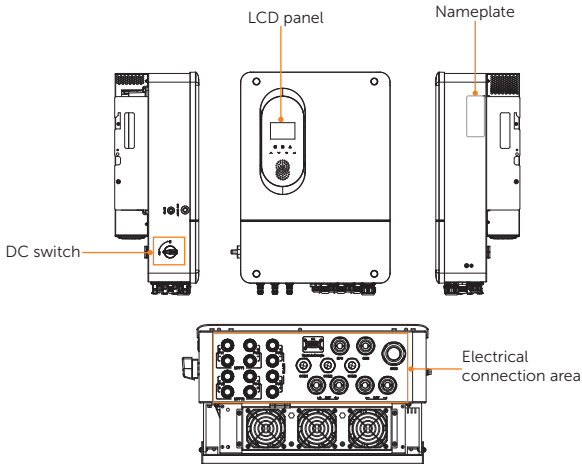

Figure 2-1 Appearance

Table 2-1 Description of appearance

Item	Description
Nameplate	Nameplate clearly identifies the device type, serial number, specific DC / AC parameters, certification, etc.
LCD panel	Including screen, indicators and keys. Screen displays the information; indicators indicate the status of inverter. Keys are used to perform the parameter setting.
DC switch	Connect or disconnect the PV input.
Electrical connection area	Including PV terminals, battery terminals, GEN, GRID and EPS terminals, communication terminals, etc.

## 2.3 Supported Power Grid

There are different ways of wiring for different grid systems. TT / TN-S / TN-C-S are shown as below:

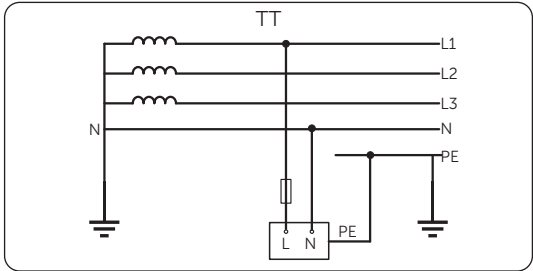

Figure 2-2 Supported power grid-TT

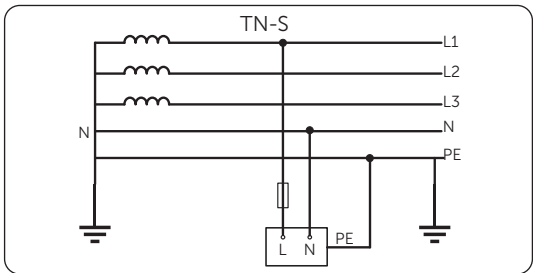

Figure 2-3 Supported power grid-TN-S

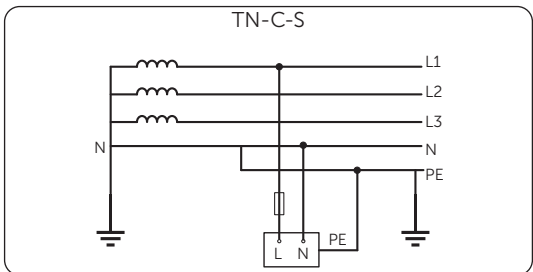













Figure 2-4 Supported power grid-TN-C-S

## 2.4 Symbols on the Label and Inverter

Table 2-2 Description of symbols

Symbol	Description
	CE mark. The inverter complies with the requirements of the applicable CE guidelines.
	TUV certified.
	Additional grounding point.
	Beware of hot surface. Do not touch a running inverter, as the inverter becomes hot during operation!
	Risk of electric shock. High voltage exists after the inverter is powered on!
	Risk of danger. Potential hazards exist after the inverter is powered on!
	Read the enclosed documentations.
	Do not dispose of the inverter together with household waste.
	Do not operate this inverter until it is isolated from battery, mains and on-site PV generation source.
 	Danger of high voltage. Do not touch live parts for 5 minutes after disconnection from the power sources.

## 2.5 Working Principle

### 2.5.1 Circuit Diagram

The inverter is equipped with multi-channel MPPT for DC input to ensure maximum power even under different photovoltaic input conditions. The inverter unit converts direct current into alternating current that meets the requirements of the power grid and feeds it into the power grid. The principle design of inverter is shown in the figure below:

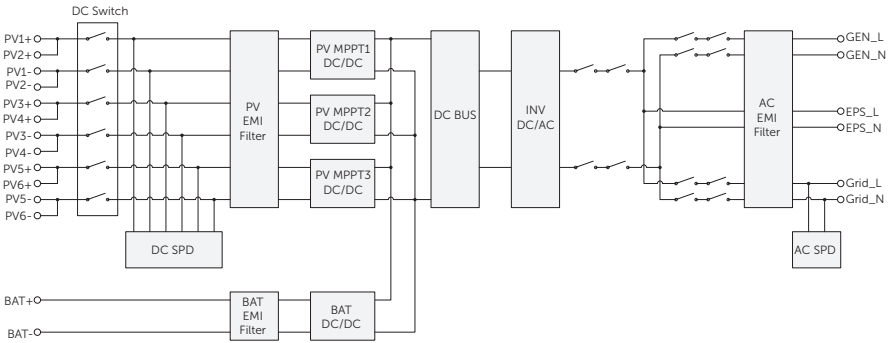

Figure 2-5 Circuit Diagram for X1-Lite-LV series inverter

#### NOTICE!

- MPPT 3 is available for 12 kW inverter.



## 2.5.2 Application Schemes

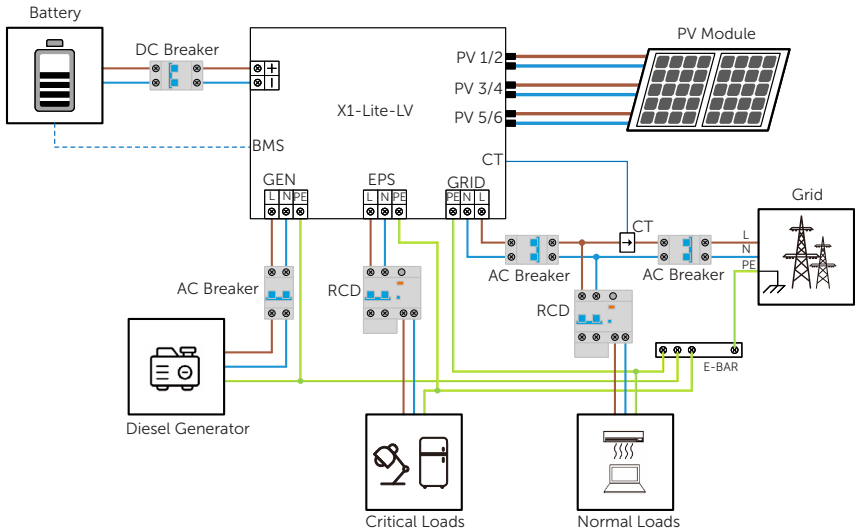

Figure 2-6 Partial home backup for most countries

## 2.6 Working State

The series inverter has INIT, IDLE, START, RUN and STOP state.

Table 2-3 Description of working state

State	Description
INIT	<ul style="list-style-type: none"> <li>The inverter is checking for the initialization information such as the model and country, the conditions to be met in order to enter IDLE state.</li> </ul>
IDLE	<ul style="list-style-type: none"> <li>The inverter is doing some preparations to enter START state, such as checking relays.</li> </ul>
START	<ul style="list-style-type: none"> <li>The inverter is being started and ready for on-grid or off-grid operation.</li> </ul>
RUN	<ul style="list-style-type: none"> <li>The inverter is working in on-grid or off-grid state.</li> </ul>
STOP	<ul style="list-style-type: none"> <li>Users power off the inverter or fault occurs to the inverter.</li> </ul>

## 2.7 Working Mode

There are different work modes of the inverter based on different needs.

Applicable areas	Work modes
Pakistan	SUB mode, SBU mode, MKS/EPS mode and Force time use mode
Countries other than Pakistan (including Vietnam, India, South Africa, etc.)	Back up mode, Self consumption mode, and Force time use mode

For how to set the working mode, please refer to ["10.3 Work Mode"](#).

### 2.7.1 SUB Mode (Pakistan)

SUB mode is applicable to Pakistan. This mode uses the energy storage system as a backup power source and is suitable for applications with frequent power outages or wish to feed excess electricity generated by PV into the grid.

Table 2-4 Description of SUB mode

Battery state	Battery Charge Source	Power Supply Situation
The battery is not fully charged	PV Only	PV → load > battery > grid <ul style="list-style-type: none"> <li>PV prioritizes supplying power to the load. If PV is insufficient, the grid supplies power to the load. If the PV output exceeds the load demand, the surplus energy is first used to charge the battery. Once the battery is fully charged, the excess energy is fed into the grid according to the <b>Export Control</b> settings. For specific settings, please refer to <a href="#">"10.4 Export Control"</a>.</li> <li>In off-grid situation, both PV and the battery supply power to the load.</li> </ul>
	PV Then Utility	PV is available: PV → load > battery > grid <ul style="list-style-type: none"> <li>Consistent with the PV Only charging situation.</li> </ul> PV is not available: grid → load+battery <ul style="list-style-type: none"> <li>The grid supplies power to the load and draws electricity from the grid to charge the battery based on the <b>Max Utility Charge Current</b>.</li> </ul>
	PV and Utility	PV → load > battery > grid, and grid → battery <ul style="list-style-type: none"> <li>PV is prioritized for the load, with excess used to charge the battery. Simultaneously, power is drawn from the grid to charge the battery based on the <b>Max Utility Charge Current</b>. After the battery is fully charged, surplus energy is either fed into the grid or curtailed according to <b>Export Control</b> settings. For specific settings, please refer to <a href="#">"10.4 Export Control"</a>.</li> </ul>

## 2.7.2 SBU Mode (Pakistan)

This mode is applicable to Pakistan and suitable for applications where electricity prices are high and PV cannot be fed into the grid. PV is prioritized for loads, and excess power is stored in the battery for later use. This mode is ideal for customers with low daytime electricity consumption and higher nighttime electricity consumption. **No Export** is set by default to disallow power feed-in to grid for this mode.

Table 2-5 Description of SBU mode

Battery state	Battery Charging And Discharging Situation	Power Supply Situation
BAT < Return to Utility Voltage/SOC	PV Only charging	PV → battery, grid → load <ul style="list-style-type: none"> <li>PV charges the battery, and the load is supplied by the grid.</li> </ul>
	PV Then Utility charging	PV is available: PV → battery > load <ul style="list-style-type: none"> <li>PV prioritizes supplying power to the battery. If the PV output exceeds the battery demand, the surplus energy is first used to supply the load.</li> </ul>
		PV is not available: grid → load+battery <ul style="list-style-type: none"> <li>The grid supplies power to the load and charge the battery based on the <b>Max Utility Charge Current</b>. For specific settings, please refer to <a href="#">"10.4 Export Control"</a>.</li> </ul>
	PV and Utility charging	PV+grid → battery, grid → load <ul style="list-style-type: none"> <li>All electricity generated by the PV is used to charge the battery, and concurrently, power is drawn from the grid to charge the battery based on the <b>Max Utility Charge Current</b>. For specific settings, please refer to <a href="#">"10.4 Export Control"</a>.</li> </ul>
BAT > Return to Battery SOC (Lithium battery)	Battery discharge	PV+battery → load <ul style="list-style-type: none"> <li>PV prioritizes supplying power to the load. If the PV is insufficient, the battery supplies power to the load until the battery voltage/SOC is less than the <b>Return to Utility SOC</b>.</li> </ul>

Battery state	Battery Charging And Discharging Situation	Power Supply Situation
BAT> <b>Return to Battery Voltage</b> (Lead acid battery)	With <b>Charge to Full</b> on, battery first charge then discharge	First PV/PV+grid/grid → battery, then PV +battery → load <ul style="list-style-type: none"> <li>The battery will continued to be charged by the charging source until it reaches the float voltage, then the inverter will work off-grid two minutes later (PV is priority to supply power to the load. If the PV is insufficient, the battery supplies power to the load until the battery voltage is less than the <b>Return to Utility Voltage</b>).</li> </ul>
	With <b>Charge to Full</b> off, battery discharge	PV+battery → load <ul style="list-style-type: none"> <li>PV prioritizes supplying power to the load. If the PV is insufficient, the battery supplies power to the load until the battery voltage is less than the <b>Return to Utility Voltage</b>.</li> </ul>

### 2.7.3 MKS/EPS Mode (Pakistan)

This mode is applicable to Pakistan and suitable for customers who have higher electricity consumption during the day and lower consumption at night.

When PV is available, the working logic will switch based on settings for **Return to SUB Mode** and **Return to SBU Mode**. At night when PV is unavailable, this mode is basically the same as the SUB mode, with the battery only charging and not discharging, which prevents the battery from being depleted.

Table 2-6 Description of MKS/EPS mode

PV state	Battery state	Inverter working state
PV is available	Battery voltage/SOC > <b>Return to SBU Mode</b>	The inverter works in basically same as the SBU mode.
	Battery voltage/SOC < <b>Return to SUB Mode</b>	The inverter works in basically same as the SUB mode, and charges the battery with the selected charging source (PV prioritizes charging the battery), and switches to basically same as the SBU mode when the battery voltage/SOC reaches <b>Return to SBU Mode</b> .
PV is unavailable	/	The inverter works in basically same as the SUB mode.

## 2.7.4 Force Time Use Mode (Pakistan)

This mode is suitable for application with peak and valley price difference. When the price of electricity is high, the battery is discharged to supply the load, and when the price of electricity is low, the battery is charged from PV or the grid to reach full capacity.

Table 2-7 Description of Force Time Use mode

Time Period	Battery Charging And Discharging Situation	Power Supply Situation
<b>Charge Period</b>	PV Only charging	PV → battery, grid → load <ul style="list-style-type: none"> <li>PV charges the battery, and the load is supplied by the grid.</li> </ul>
	PV Then Grid charging	PV+grid → battery+load <ul style="list-style-type: none"> <li>PV prioritizes charging the battery, if the PV is insufficient, electricity is drawn from the grid to charge the battery. The load is supplied by the grid.</li> </ul>
	PV and Grid charging	PV+grid → battery+load <ul style="list-style-type: none"> <li>All electricity generated by the PV is used to charge the battery, and concurrently, power is drawn from the grid to charge the battery based on the <b>Max Utility Charge Current</b>. For specific settings, please refer to "10.4 Export Control".</li> </ul>
<b>Home Load Removed From Utility Time Periods</b>	Battery discharge	Battery+grid → load <ul style="list-style-type: none"> <li>The battery discharges to supply the load until the battery voltage is less than the <b>Battery Stop Discharge Voltage</b> or SOC, after which the load will be supplied by the grid.</li> </ul>
Outside of peak-valley scheduled time periods	The battery charges according to the priority settings of the battery charging source mode.	

### 2.7.5 Back Up Mode (Other Countries)

Back up mode is applicable to countries other than Pakistan.

This mode uses the energy storage system as a backup power source and is suitable for applications with frequent power outages or wish to feed excess electricity generated by PV into the grid.

Table 2-8 Description of Back Up mode

Battery state	Battery Charge Source	Power Supply Situation
The battery is not fully charged	PV Only	<p>PV → load &gt; battery &gt; grid</p> <ul style="list-style-type: none"> <li>PV prioritizes supplying power to the load. If PV is insufficient, the grid supplies power to the load. If the PV output exceeds the load demand, the surplus energy is first used to charge the battery. Once the battery is fully charged, the excess energy is fed into the grid according to the <b>Export Control</b> settings. For specific settings, please refer to "10.4 Export Control".</li> <li>In off-grid situation, both PV and the battery supply power to the load.</li> </ul>
	PV Then Utility	<p>PV is available: PV → load &gt; battery &gt; grid</p> <ul style="list-style-type: none"> <li>Consistent with the PV Only charging situation.</li> </ul> <p>PV is not available: grid → load+battery</p> <ul style="list-style-type: none"> <li>The grid supplies power to the load and draws electricity from the grid to charge the battery based on the <b>Max Utility Charge Current</b>.</li> </ul>
	PV and Utility	<p>PV → load &gt; battery &gt; grid and grid → battery</p> <ul style="list-style-type: none"> <li>PV is prioritized for the load, with excess used to charge the battery. Simultaneously, power is drawn from the grid to charge the battery based on the <b>Max Utility Charge Current</b>. After the battery is fully charged, surplus energy is either fed into the grid or curtailed according to <b>Export Control</b> settings. For specific settings, please refer to "10.4 Export Control".</li> </ul>

## 2.7.6 Self Consumption Mode (Other Countries)

This mode is applicable to countries other than Pakistan and suitable for applications where electricity prices are high and PV cannot be fed into the grid. PV is prioritized for loads, and excess power is stored in the battery for later use. This mode is ideal for customers with low daytime electricity consumption and higher nighttime electricity consumption. **No Export** is set by default to disallow power feed-in to grid for this mode.

There are three options under this mode, i.e. **Self Comp**, **Battery First** and **Load First**, among which the working logic is slightly different.

Table 2-9 Description of Self Consumption mode  
- Self Comp

Battery state	Battery Charging And Discharging Situation	Power Supply Situation
BAT<Return to Utility Voltage/SOC	PV Only charging	PV → battery, grid → load <ul style="list-style-type: none"> <li>PV charges the battery, and the load is supplied by the grid.</li> </ul>
	PV Then Utility charging	PV is available: PV → battery > load <ul style="list-style-type: none"> <li>PV prioritizes supplying power to the battery. If the PV output exceeds the battery demand, the surplus energy is first used to supply the load.</li> </ul>
		PV is not available: grid → load+battery <ul style="list-style-type: none"> <li>The grid supplies power to the load and charge the battery based on the <b>Max Utility Charge Current</b>. For specific settings, please refer to "10.4 Export Control".</li> </ul>
	PV and Utility charging	PV+grid → battery, grid → load <ul style="list-style-type: none"> <li>All electricity generated by the PV is used to charge the battery, and concurrently, power is drawn from the grid to charge the battery based on the <b>Max Utility Charge Current</b>. For specific settings, please refer to "10.4 Export Control".</li> </ul>
BAT>Return to Battery Voltage/SOC	Battery discharge	PV+battery → load <ul style="list-style-type: none"> <li>PV prioritizes supplying power to the load. If the PV is insufficient, the battery supplies power to the load until the battery voltage/SOC is less than the <b>Return to Utility Voltage/SOC</b>.</li> </ul>

Table 2-10 Description of Self Consumption mode  
- Load First and Battery First

Option	PV State	Power Supply Situation
<b>Load First</b>	PV is sufficient	PV → load > battery • PV prioritizes supplying power to the load. If the PV output exceeds the load demand, the surplus energy is used to charge the battery.
	PV is insufficient	PV+battery → load • Both PV and battery supply power to the load. When the battery voltage/SOC < <b>Return to Utility Voltage/SOC</b> , the battery will stop discharging.
<b>Battery First</b>	PV > battery maximum charging power	PV → battery > load • PV prioritizes supplying power to the battery. If the PV output exceeds the battery demand, the surplus energy is used to supply the load.
	PV < battery maximum charging power	• If the charge source is selected as <b>PV Only</b> or <b>PV then Utility</b> , the battery is supplied solely by PV (PV → battery). • If the charge source is selected as <b>PV and Utility</b> , the battery is supplied by both PV and grid (PV+grid → battery).
	PV is unavailable	• If the charge source is selected as <b>PV Only</b> , the battery won't be charged. • If the charge source is selected as <b>PV then Utility</b> or <b>PV and Utility</b> , the battery is supplied by the grid (grid → battery).



## 2.7.7 Force Time Use Mode (Other Countries)

This mode is suitable for application with peak and valley price difference. When the price of electricity is high, the battery is discharged to supply the load, and when the price of electricity is low, the battery is charged from PV or the grid to reach full capacity\*.

Table 2-11 Description of Force Time Use mode

Time Period	Battery Charging And Discharging Situation	Power Supply Situation
<b>Charge Period</b>	PV Only charging	PV → battery, grid → load <ul style="list-style-type: none"> <li>PV charges the battery, and the load is supplied by the grid.</li> </ul>
	PV Then Grid charging	PV+grid → battery+load <ul style="list-style-type: none"> <li>PV prioritizes charging the battery, if the PV is insufficient, electricity is drawn from the grid to charge the battery. The load is supplied by the grid.</li> </ul>
	PV and Grid charging	PV+grid → battery+load <ul style="list-style-type: none"> <li>All electricity generated by the PV is used to charge the battery, and concurrently, power is drawn from the grid to charge the battery based on the <b>Max Utility Charge Current</b>. For specific settings, please refer to "10.4 Export Control".</li> </ul>
<b>Discharge Period</b>	Battery discharge	Battery+grid → load <ul style="list-style-type: none"> <li>The battery discharges to supply the load until the battery voltage is less than the <b>Battery Stop Discharge Voltage</b> or SOC, after which the load will be supplied by the grid.</li> </ul>
Outside of peak-valley scheduled time periods	The battery charges according to the priority settings of the battery charging source mode.	

**\* Note:**

For Vietnam, there are additional **Charge Stop VOL/SOC** (the battery will cease charging when reach this value) and **Max Charge Power** that can be set for the charge periods and **Max Discharge Power** for the discharge periods.

# 3 System Overview

## System Overview

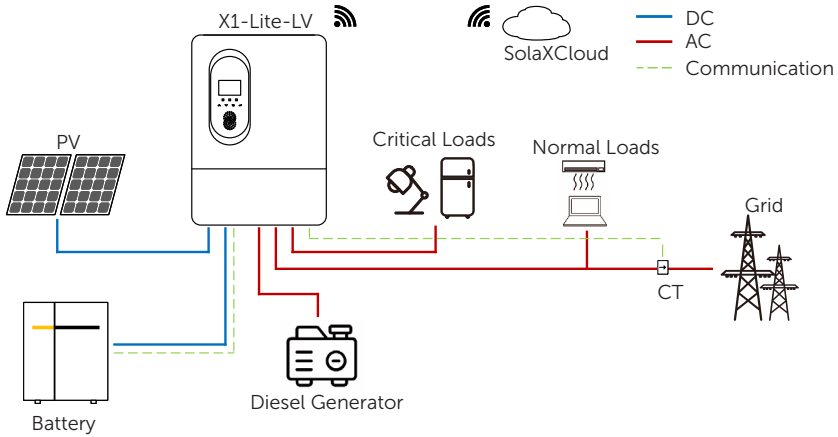

Figure 3-1 System diagram

Table 3-1 System item description

Item	Description
X1-Lite-LV series inverter (the device covered in this manual)	The X1-Lite-LV series inverter is an energy storage inverter that supports grid connection of photovoltaic system.
PV modules	PV modules work in MPPT mode. The maximum number of MPPT is two for 8 kW and 10 kW inverters and three for 12 kW inverters.
Battery	The series inverter should be coupled low voltage battery (Lithium or Lead-Acid). The battery with the same capacity and the same model can be installed simultaneously. It communicates with the inverter via BMS and must comply with the specifications of the regulations.
Meter/CT	The meter/CT is used by the inverter for import / export or consumption readings, and manages the battery charge / discharge accordingly for smart energy management applications.

---

Item	Description
Generator	SolaX PV-Genset solution ensures optimum interaction between the photovoltaics and diesel generator, which saves fuel, lowers energy costs and ensures a stable and reliable power supply.
Grid	220 V / 230 V and 240 V grid are supported.
SolaXCloud	SolaXCloud is an intelligent, multifunctional monitoring platform that can be accessed either remotely or through a hard wired connection. With the SolaXCloud, the operators and installers can always view key and up to date.

---

# 4 Transportation and Storage

---

If the inverter is not put into use immediately, the transportation and storage requirements need to be met:

## Transportation

- Observe the caution signs on the packaging of inverter before transportation.
- Pay attention to the weight of the inverter. Carry the inverters by the required number of personnel as specified by local regulations.
- Wear protective gloves when carrying the equipment by hand to prevent injuries.
- When lifting up the inverter, hold the bottom position of the carton. Keep the inverter horizontal in case of falling down.

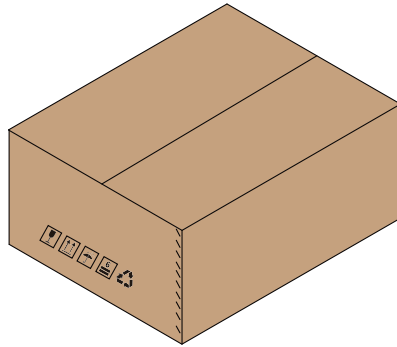

Figure 4-1 Caution signs on the packaging

## Storage

- The inverter must be stored indoors.
- Do not remove the original packaging material and check the outer packaging material regularly.
- The storage temperature should be between  $-40^{\circ}\text{C}$  and  $+70^{\circ}\text{C}$ . The relative humidity should be between 4%RH and 100%RH.
- Stack the inverter in accordance with the caution signs on the inverter carton to prevent their falling down and device damage. Do not place it upside down.

# 5 Preparation before Installation

## 5.1 Selection of Installation Location

The installation location selected for the inverter is quite critical in the aspect of the guarantee of machine safety, service life and performance. It has the IP65 ingress protection, which allows it to be installed outdoor. The installation position shall be convenient for wiring connection, operation and maintenance.

### 5.1.1 Environment Requirement

Make sure the installation environment meets the following conditions:

- The ambient temperature:  $-25^{\circ}\text{C}$  to  $+60^{\circ}\text{C}$ .
- The relative humidity shall be between 4-100%RH.
- Do not install the inverter in the areas where the altitude exceeds 3000 m.
- Install the inverter in a well-ventilated environment for heat dissipation. You are recommended to install an awning over the inverter if it is installed on a support outdoor.
- Do not install the inverter in areas with flammable, explosive and corrosive materials or near antenna.
- Avoid direct sunlight, rain exposure and snow accumulation.

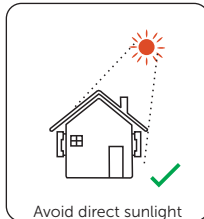
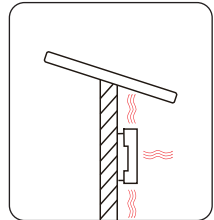
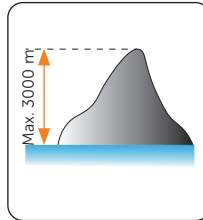
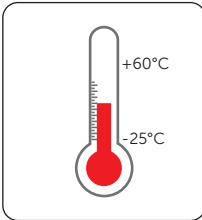

**NOTICE!**

- For outdoor installation, precautions against direct sunlight, rain exposure and snow accumulation are recommended.
- Exposure to direct sunlight raises the temperature inside the device. This temperature rise poses no safety risks, but may impact the device performance.
- Install the inverter at least 500 meters away from the coast and avoid sea breeze directly hit.

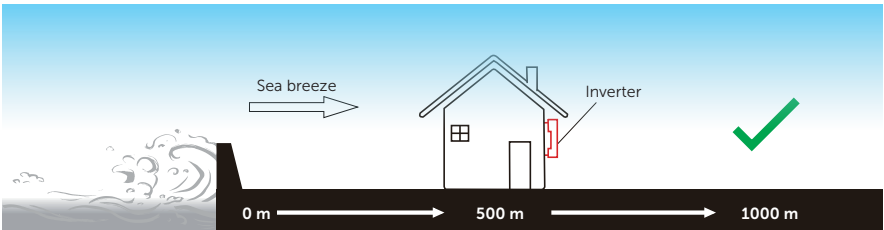

Figure 5-1 Recommended installation position

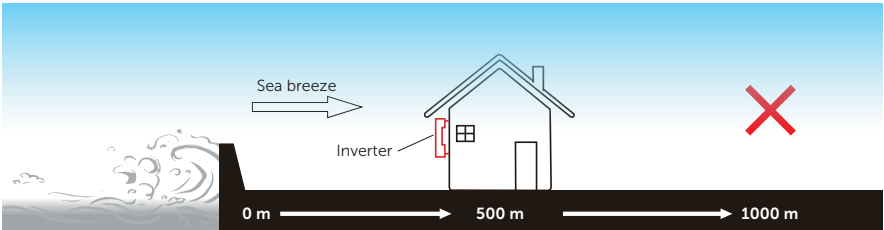

Figure 5-2 Incorrect installation position

**NOTICE!**

- For the installation of the whole system, please refer to the specific environment requirement of each unit.

### 5.1.2 Installation Carrier Requirement

The installation carrier must be made of a non-flammable material, such as solid brick, concrete, etc. and be capable of supporting the weight of the inverter and suitable of the dimensions of the inverter. If the wall strength is not enough (such as wooden wall, the wall covered by thick layer of decoration), it must be strengthened additionally.

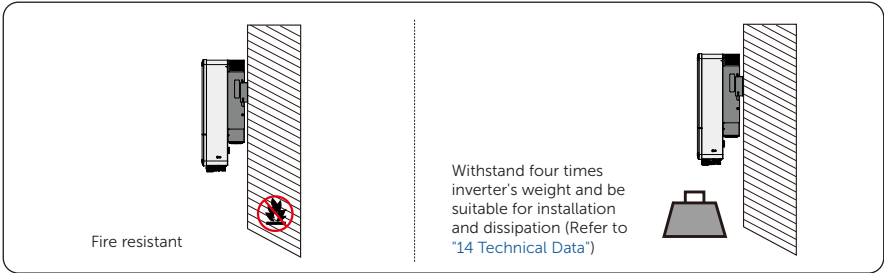

Figure 5-3 Installation carrier requirement

### 5.1.3 Clearance Requirement

The minimum clearance reserved for the connected terminal at the bottom of inverter should be 14 cm. When planning installation space, it is important to consider the bending radius of the wires.

To guarantee proper heat dissipation and ease of disassembly, the minimum space around the inverter must meet the standards indicated below.

For installations with multiple inverters, make sure to leave a minimum space of 60 cm between each inverter. In areas with high ambient temperatures, increase the clearances between the inverters and provide adequate fresh air ventilation if feasible.

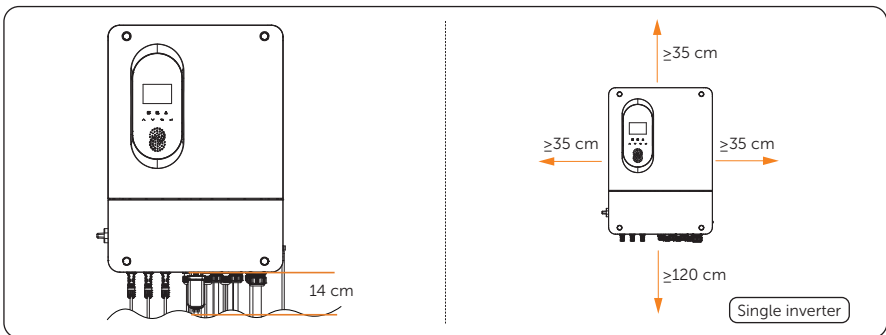

Figure 5-4 Clearance requirement for single inverter

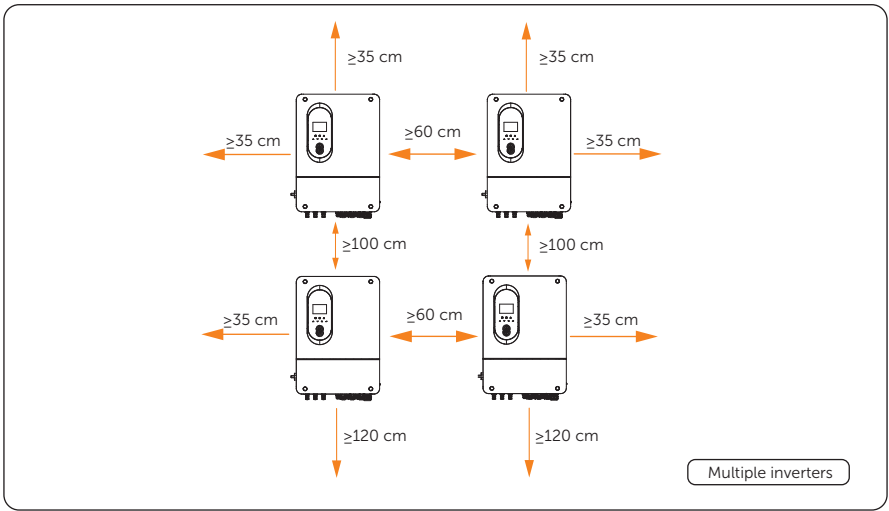

Figure 5-5 Clearance requirement for multiple inverters



## 5.2 Tools Requirement

Installation tools include but are not limited to the following recommended ones. If necessary, use other auxiliary tools on site. Please note that the tools used must comply with local regulations.



### 5.3 Additionally Required Materials

Table 5-1 Additionally required wires





No.	Required Material	Type	Conductor Cross-section	
1	PV wire		Dedicated PV wire with a voltage rating of 600 V	4-6 mm <sup>2</sup>
2	Communication wire		Network cable CAT5E	0.2 mm <sup>2</sup>
3	Battery power cable		Conventional copper wire	35-50 mm <sup>2</sup>
4	Additional PE wire		Conventional yellow and green wire	10-16 mm <sup>2</sup>

Table 5-2 Wire and breaker recommended for Grid connection



Model	8 kW	10 kW	12 kW
Wire (copper) 	10 mm <sup>2</sup>	16 mm <sup>2</sup>	16 mm <sup>2</sup>
Circuit breaker 	60 A	80 A	100 A

Table 5-3 Wire and breaker recommended for EPS connection



Model	8 kW	10 kW	12 kW
Wire (copper) 	8 mm <sup>2</sup>	10 mm <sup>2</sup>	16 mm <sup>2</sup>
Circuit breaker 	50 A	60 A	80 A

Table 5-4 Wire and breaker recommended for GEN connection

Model	8 kW	10 kW	12 kW
Wire (copper) 	10 mm <sup>2</sup>	16 mm <sup>2</sup>	16 mm <sup>2</sup>
Circuit breaker 	60 A	80 A	100 A

# 6 Unpacking and Inspection

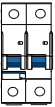
---

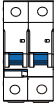
## 6.1 Unpacking

- The inverter undergoes 100% testing and inspection before delivery. However, damages may still occur during transportation. Before unpacking, please carefully check the external packaging for any signs of damage, such as punctures or cracks.
- Unpacking the inverter according to the following figure.

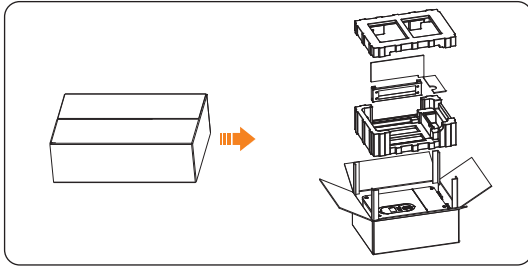

Figure 6-1 Unpacking the inverter

- Properly handle all the packaging materials in case they may be reused for storage and transportation of the inverter in the future.
- Upon opening the package, check whether the inverter is intact and whether all accessories are included. If any damage is found or any parts are missing, contact your dealer immediately.

## 6.2 Scope of Delivery

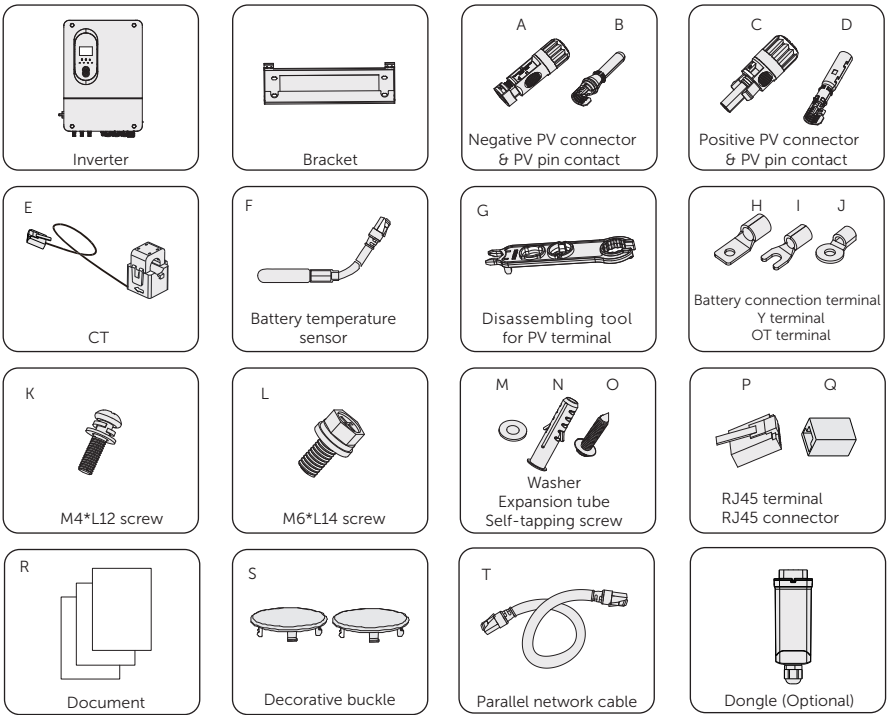

Table 6-1 Packing list

Item	Description	Quantity	Remark
/	Inverter	1 pc	
/	Bracket	1 pc	
A	Negative PV connector	4 pairs for 8kW~10kW inverters 6 pairs for 12kW inverter	
B	Negative PV pin contact	4 pairs for 8kW~10kW inverters 6 pairs for 12kW inverter	
C	Positive PV connector	4 pairs for 8kW~10kW inverters 6 pairs for 12kW inverter	
D	Positive PV pin contact	4 pairs for 8kW~10kW inverters 6 pairs for 12kW inverter	
E	CT	1 pc	
F	Battery temperature sensor	1 pc	For measuring the temperature of battery

## Unpacking and Inspection

Item	Description	Quantity	Remark
G	Disassembling tool for PV terminal	1 pc	
H	Battery connection terminal	4 pcs	
I	Y terminal	9 pcs	For Grid, EPS, GEN connection
J	OT terminal	1 pc	For grounding
k	M4*L12 screw	2 pcs	For fixing the inverter
L	M6*L14 screw	1 pc	For grounding
M	Washer	4 pcs	For fixing the bracket
N	Expansion tube	4 pcs	For fixing the bracket
O	Self-tapping screw	4 pcs	For fixing the bracket
P	RJ45 terminal	4 pcs	
Q	RJ45 connector	2 pcs	
R	Document	/	
S	Decorative buckle	2 pcs	For decorating the lower cover
T	Parallel network cable	1 pc	For parallel connection
/	Dongle (Optional)	1 pc	

### NOTICE!

- Refer to the actual delivery for the optional accessories.

# 7 Mechanical Installation

## WARNING!

- Only qualified personnel are allowed to perform the mechanical installation following local laws and regulations.
- Check the existing power cables or other piping in the wall to prevent electric shock or other damage.
- Use insulated tools and wear personal protective equipment throughout the installation and maintenance process.

## CAUTION!

- During installation, always be cautious about the weight of the inverter. Improper lifting or dropping of the inverter may result in personal injury.

## NOTICE!

- Install the inverter at a maximum back tilt of 15 degrees and avoid forward tilted, side tilted, or upside down.

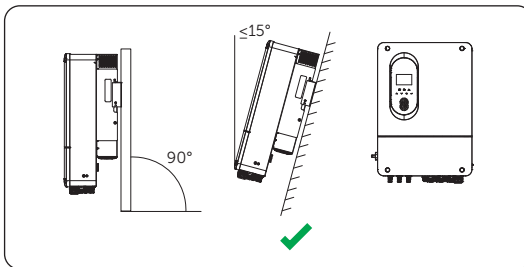

Figure 7-1 Correct installation

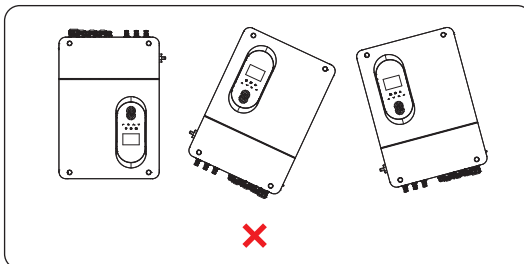

Figure 7-2 Incorrect installation

## 7.1 Dimensions for mounting

Before installation, check the dimensions of the wall mounting bracket and ensure that enough space is reserved for the installation and heat dissipation of the entire system.

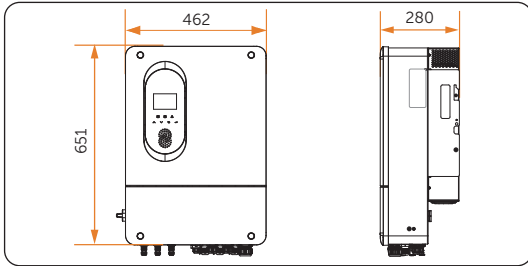

Figure 7-3 Dimensions 1 (Unit: mm)

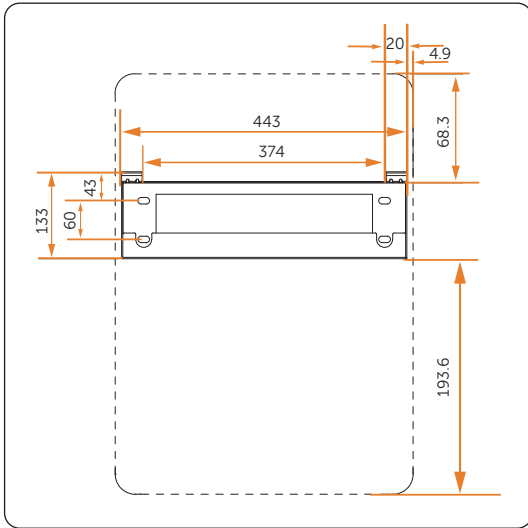

Figure 7-4 Dimensions 2 (Unit: mm)



## 7.2 Installation procedures

**Step 1:** Horizontally align the wall mounting bracket with the wall, adjust the position of the bracket with a spirit level until the bubble stays in the middle, and then mark holes. The minimum distance between the ground and the inverter is 1200 mm.

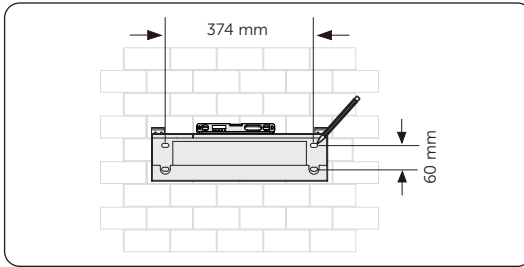

Figure 7-5 Marking the holes

**Step 2:** Set the wall mounting bracket aside and drill holes with  $\varnothing 10$  drill bit. The depth of the holes should be over 80 mm.

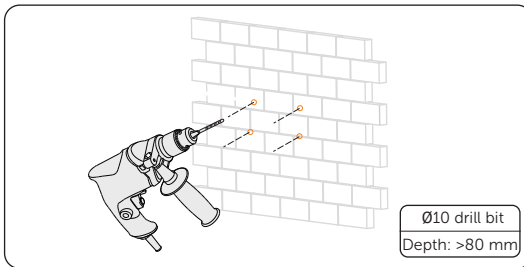

Figure 7-6 Drilling holes

**Step 3:** Knock the expansion tubes (Part N) into the holes. Attach the wall mounting bracket on the wall again. Insert the self-tapping screws (Part O) into the holes and secure it to the wall by torque wrench.

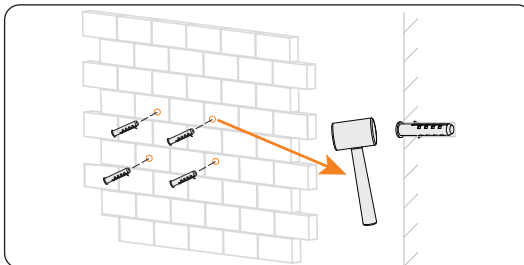

Figure 7-7 Knocking the expansion tubes

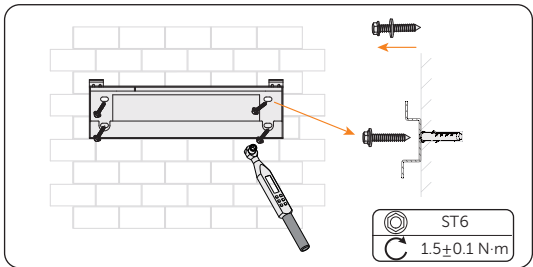

Figure 7-8 Securing the wall mounting bracket

**Step 4:** If the inverter needs to be temporarily placed on the ground, use foam or other protective materials to protect it against potential damages. Lift up the inverter collaboratively by the required number of personnel in accordance with the local regulation and hang it onto the wall mounting bracket. Make sure that the hanging holes of the inverter are properly inserted into the lugs of the bracket.

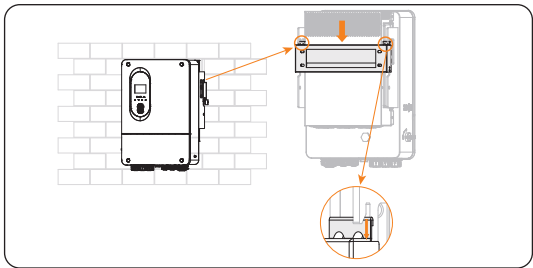

Figure 7-9 Hanging the inverter

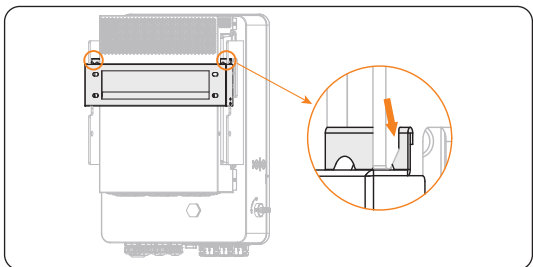

Figure 7-10 Hanging the inverter

**Step 5:** Use M4\*L12 screws (Part K) to secure the inverter on both sides.

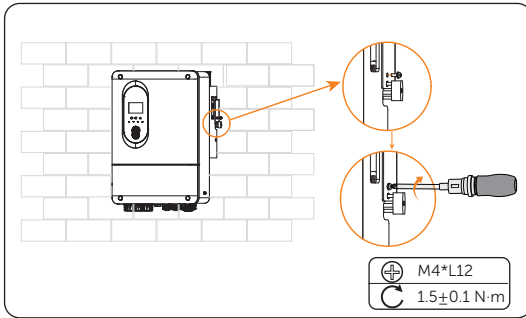

Figure 7-11 Securing the inverter

# 8 Electrical Connection

---

 **DANGER!**

- Before electrical connection, make sure the DC switch and AC breaker are disconnected. Otherwise, the high voltage may cause electric shock, resulting in severe personal injuries or even death.

 **WARNING!**

- Only qualified personnel are allowed to perform the electrical connection following local laws and regulations.
- Strictly follow the instructions of this manual or other related documentation for electrical connection. Inverter damages caused by incorrect wiring is not covered by the warranty.
- Use insulated tools and wear personal protective equipment throughout the electrical connection process.

## 8.1 Terminals of Inverter

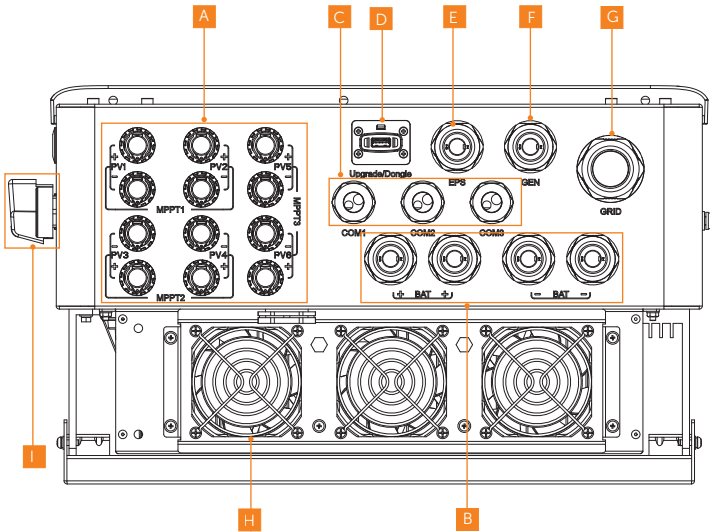

Figure 8-1 Terminals of Inverter

Table 8-1 Description of terminals

Item	Description	Remarks
A	PV connection terminal	PV1 ~ PV4 terminals for 8 and 10 kW inverter; PV1 ~ PV6 terminals for 12 kW inverter
B	Battery connection terminal	
C	COM communication terminal	Including DI/COM, DO, BMS, DRM, METER/CT_1, METER/CT_2, ParalleL_1, ParalleL_2
D	Upgrade/Dongle terminal	
E	EPS connection terminal	
F	GEN connection terminal	
G	GRID connection terminal	
H	Fan	
I	DC switch	

## 8.2 PE Connection

The inverter must be reliably grounded. The PE connection point has been marked with



It is recommended to connect the inverter to a nearby grounding point.

### PE connection procedures

**Step 1:** Strip the insulation of the PE cable to an appropriate length.

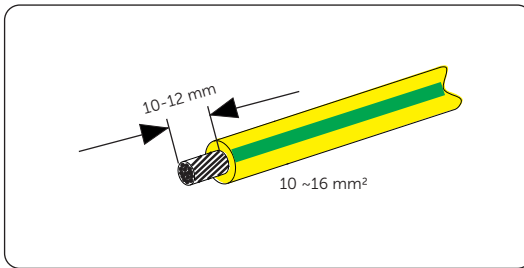

Figure 8-2 Stripping the PE cable

**Step 2:** Pull the heat-shrink tubing over the PE cable and insert the stripped section into the OT terminal (Part J).

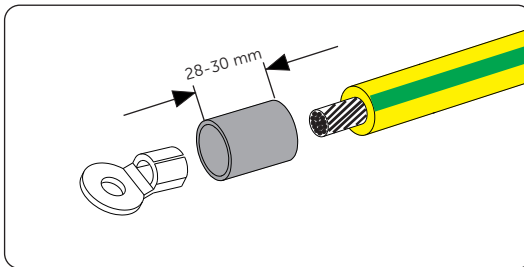

Figure 8-3 Installing the tubing and OT terminal

**Step 3:** Crimp it with crimping tool, pull the heat-shrink tubing over the crimped section and use a heat gun to shrink it so that it can be firmly contacted with the terminal.

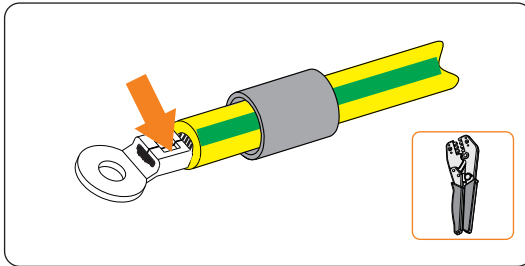

Figure 8-4 Crimping the cable

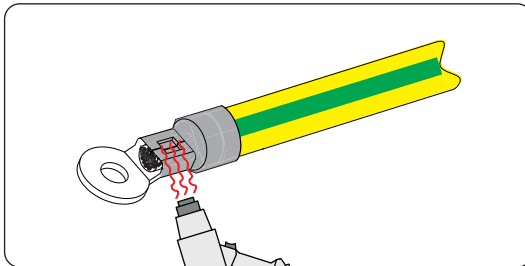

Figure 8-5 Shrinking the tubing

**Step 4:** Connect the assembled PE cable to the grounding point of the inverter, and secure it with the M6\*14 screw (Part L) in the packing list. (Torque:  $3\pm 0.3$  N·m)

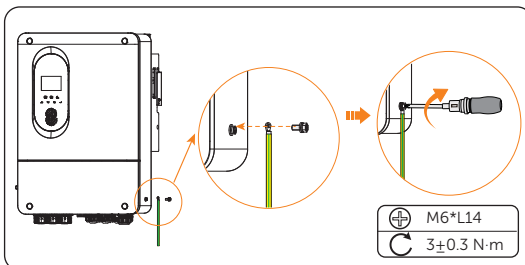

Figure 8-6 Securing the PE cable

### 8.3 EPS, GEN and GRID Connection

**NOTICE!**

- Before connecting the inverter to the grid, approval must be received by local utility as required by national and state interconnection regulations.

The inverter supports the EPS mode. When connected to the grid, the inverter outputs go through the Grid terminal, and when disconnected from the grid, the inverter outputs go through the EPS terminal.

#### Requirements for EPS, GEN and GRID connection

- Grid voltage requirement
  - » The grid voltage and frequency must be within the allowable range (220 V / 230 V / 240V, 50 / 60 Hz) and comply with the requirements of the local power grid.
- Residual Current Device (RCD)
  - » The inverter has an integrated Type-B Residual Current Monitoring Unit (RCMU). If an external RCD is required by local regulations, a 300 mA Type-A RCD is recommended. If required by local regulations, a Type-B RCD is also permitted.
- AC breaker
  - » An AC breaker that matches the power of the inverter must be used between the inverter output and the power grid. Each inverter must be equipped with an independent breaker or other load disconnection unit to ensure the safe disconnection from the grid. For specific information on the AC breaker for Grid, EPS and GEN, see "5.3 Additionally Required Materials".
- EPS load
  - » Make sure that the rated power of the EPS load is within the rated output power range of the inverter. Otherwise, the inverter will report an **Overload Fault** alarm. In this case, turn off some loads to suit the rated EPS output power range of the inverter, and then press the **ESC** key on the LCD screen to clear the fault.
  - » When connecting to the EPS terminal, pay attention to the following points:

Medical equipment	Connection prohibited
Precision instrument	Connection prohibited
Appliances susceptible to malfunctions in the event of power outages during use.	Connection prohibited



- » For inductive loads such as refrigerators, air conditioner, washing machine, etc., ensure that their start power does not exceed the EPS peak power of the inverter.

Table 8-2 EPS load information

Type of load	Equipment	Start power
Resistive load	Lamp	Rated power
	Fan	Rated power
	Hair dryer	Rated power
	Refrigerator	3-5 times rated power
Inductive load	Air conditioner	3-6 times rated power
	Washing machine	3-5 times rated power
	Microwave oven	3-5 times rated power

\* Refer to the nominal start power of the equipment for the actual start power.

## Wiring procedures

### NOTICE!

- Please refer to the table in Additionally Required Materials to view the recommended wire sizes for GRID, EPS, and GEN.
- For 8 kW inverter, the size of Y terminal is 10 mm<sup>2</sup>. For 10 kW and 12 kW inverters, the size of Y terminal is 16 mm<sup>2</sup>.

**Step 1:** Prepare three-core cables as the EPS, GEN and GRID cables and strip the insulation of L, N and the grounding conductor to an appropriate length. Insert the conductors L, N, and grounding conductor into the Y terminals (Part I).

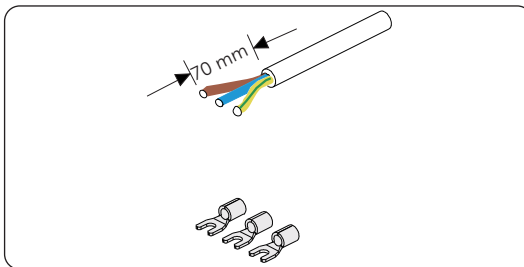

Figure 8-7 Stripping cables

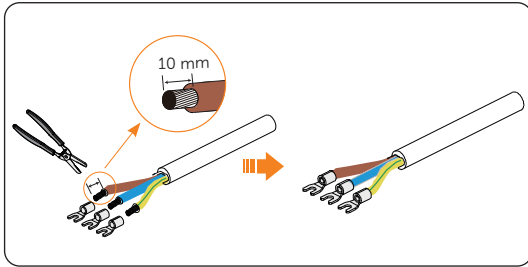

Figure 8-8 Stripping cables

**Step 2:** Use crimping tool to crimp it. Make sure the conductors are correctly assigned and firmly seated in the Y terminals.

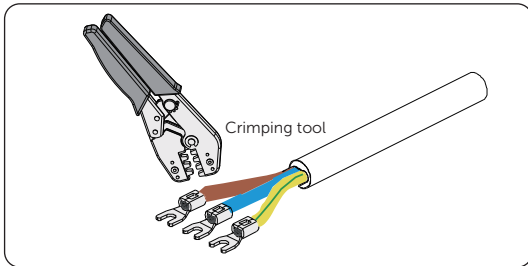

Figure 8-9 Crimping the conductors

**Step 3:** Use a cross screwdriver to loosen the M6 screws on both sides of the inverter. Then remove the lower cover of the inverter. (Torque:  $3 \pm 0.3$  N·m)

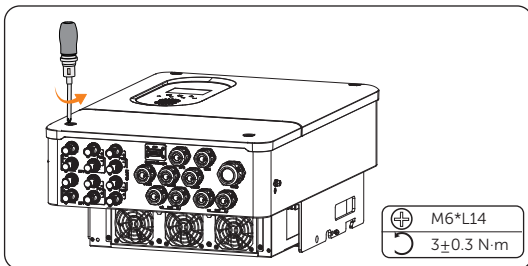

Figure 8-10 Loosening the screws

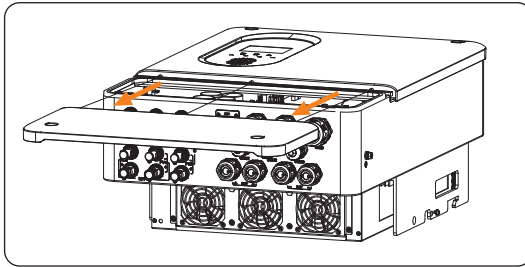

Figure 8-11 Removing the lower cover

**Step 4:** Disassemble EPS, GEN and GRID ports. And remove the plugs and sealing cover as shown below. It is recommended to seal unused plugs with fireproof putty.

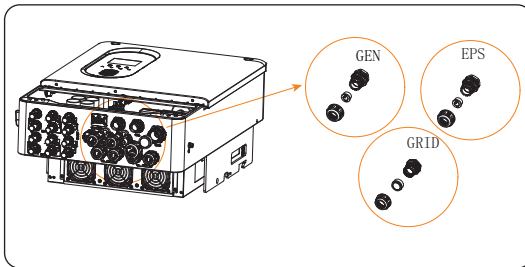

Figure 8-12 Removing the plugs

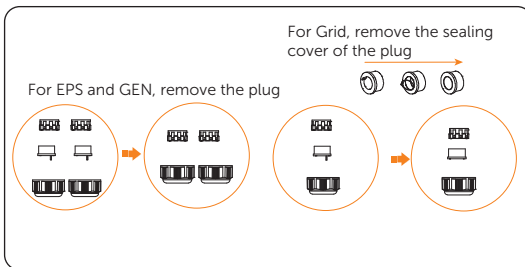

Figure 8-13 Removing the plugs

**NOTICE!**

- For EPS and GEN, remove the plug. For Grid, remove the sealing cover of the plug. Keep the plugs in a safe place, seal the unused terminals with them.

**Step 5:** Find the location of EPS, GEN and GRID connection port.

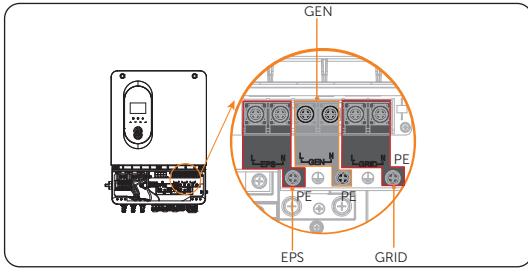

Figure 8-14 Finding the location

**Step 6:** Thread EPS, GEN and Grid cables through the corresponding EPS, GEN and Grid ports.

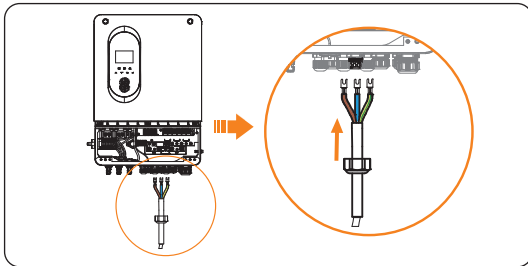

Figure 8-15 Threading the EPS cable

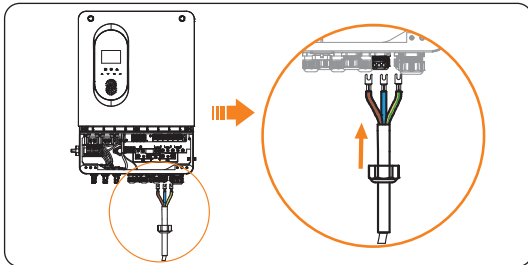

Figure 8-16 Threading the GEN cable

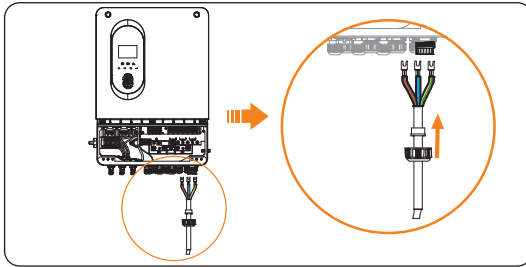

Figure 8-17 Threading the GRID cable

**Step 7:** Loosen the M6 screws to insert the crimped conductors. (Torque:  $3 \pm 0.3$  N·m)

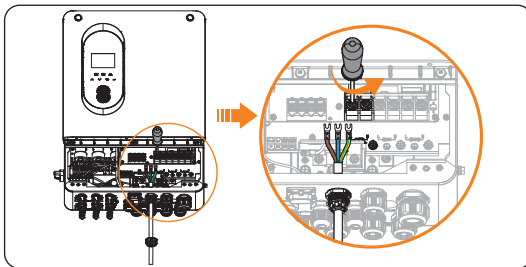

Figure 8-18 Loosening the EPS screws

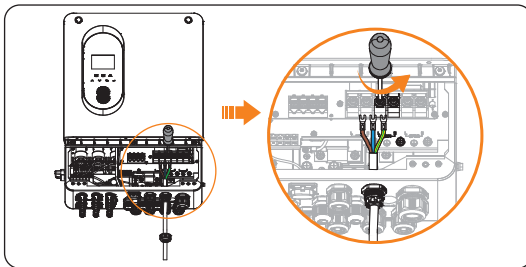

Figure 8-19 Loosening the GEN screws

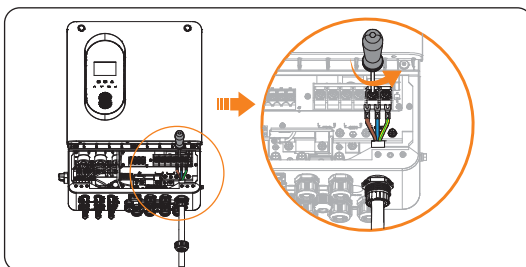

Figure 8-20 Loosening the GRID screws

**Step 8:** Insert the crimped conductors L, N, and grounding conductor into the terminals according to the wire sequence and tighten the screws with a cross screwdriver (Torque:  $3 \pm 0.3N \cdot m$ ). Then tighten the swivel nut.

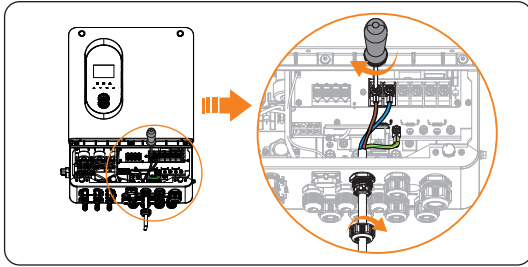

Figure 8-21 Connecting the EPS cable

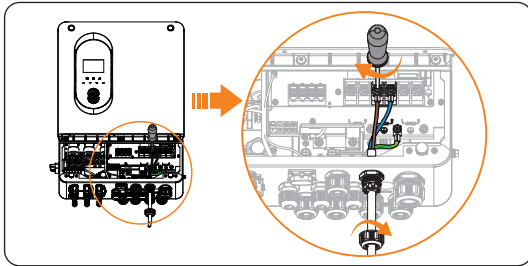

Figure 8-22 Connecting the GEN cable

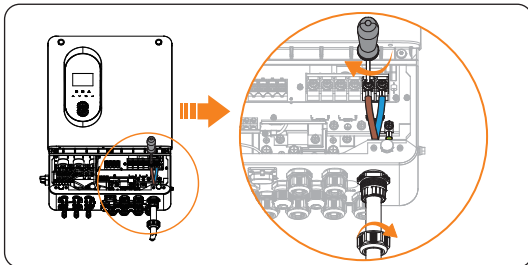

Figure 8-23 Connecting the GRID cable

**! DANGER!**

- Before powering on the inverter, seal the unused terminals of EPS, GRID and GEN with the plugs. Otherwise, electrical shock may be caused by high voltage, resulting in serious personal injury or death.

## 8.4 PV Connection

### DANGER!

- When exposed to the sunlight, PV modules will generate lethal high voltage. Please take precautions.
- Before connecting the PV modules, make sure that both DC switch and AC breaker are disconnected, and that the PV module output is securely isolated from the ground.

### WARNING!

- To mitigate the risk of fire, it is crucial to utilize a dedicated crimping tool specifically designed for PV installations to ensure secure and reliable connections.

### CAUTION!

- Power is fed from more than one source and more than one live circuit.

### Requirements for PV connection

- Open circuit voltage and operating voltage
  - » The open circuit voltage of each module array cannot exceed the maximum PV input voltage (600 V) of the inverter. Otherwise, the inverter may be damaged.
  - » The operating voltage of PV modules must be within the MPPT voltage range (50-550 V) of the inverter. Consider the impact of low temperature on the voltage of the photovoltaic panels, as lower temperatures tend to result in higher voltages.
- PV module
  - » The PV modules within the same MPPT channel are of the same brand. Additionally, the strings within the same channel should have identical quantities, and be aligned and tilted identically.
  - » The positive or negative pole of the PV modules is not grounded.
  - » The positive cables of the PV modules must be connected with positive DC connectors.
  - » The negative cables of the PV modules must be connected with negative DC connectors.

### Wiring procedures

**Step 1:** Strip the insulation of the PV cables to an appropriate length.

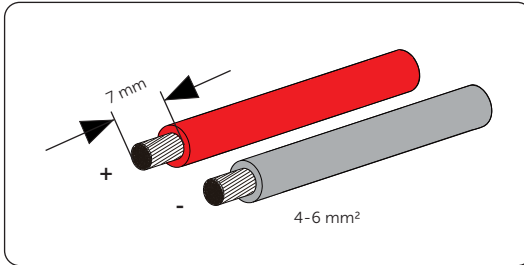

Figure 8-24 Stripping the PV cable

**Step 2:** Insert the stripped cable into the PV pin contact (Part B&D).

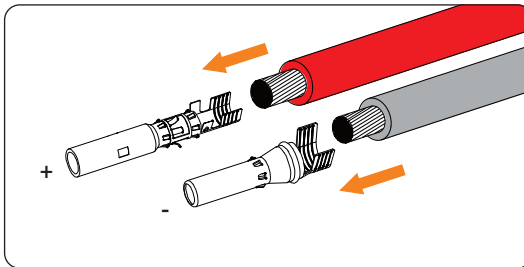

Figure 8-25 Inserting the PV pin contact

**Step 3:** Make sure the PV cable and PV pin contact are of the same polarity. Crimp it with crimping tool for PV terminal. Pay attention to the crimping position.

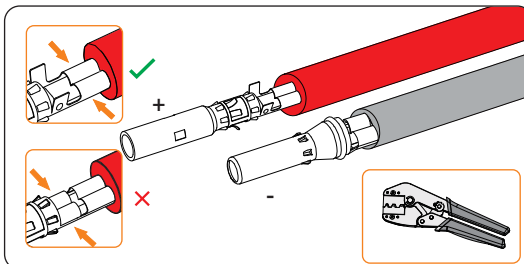

Figure 8-26 Crimping the terminal



**Step 4:** Thread the PV cable through swivel nut and insert the cable into the PV connector (Part A&C) .

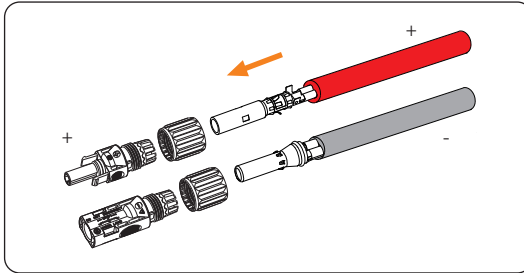

Figure 8-27 Threading the PV cable

**Step 5:** A "Click" will be heard if it is connected correctly. Gently pull the cable backward to ensure firm connection. Tighten the swivel nut. Verify that the PV connectors have the correct polarity before connection.

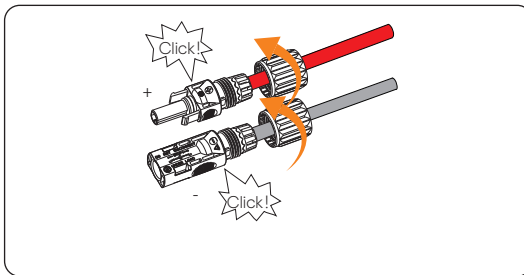

Figure 8-28 Securing the PV cable

**Step 6:** Use a voltage measuring device which complies with the local regulation to measure the positive and negative voltage of the assembled PV connectors. Make sure the open circuit voltage does not exceed the input limit of 600 V.

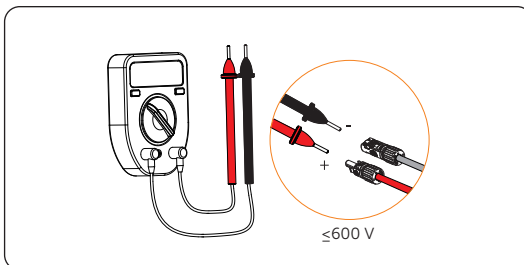

Figure 8-29 Measuring the voltage of PV connectors

**NOTICE!**

- If the voltage reading is negative, it indicates an incorrect DC input polarity. Please check if the wiring connections on the measuring device is correct or PV connectors are not mistakenly connected.

**Step 7:** Remove the PV terminal caps and connect the assembled PV connectors to corresponding terminals until there is an audible "Click". The PV+ on the string side must be connected to the PV+ on the inverter side, and the PV- on the string side must be connected to the PV- on the inverter side.

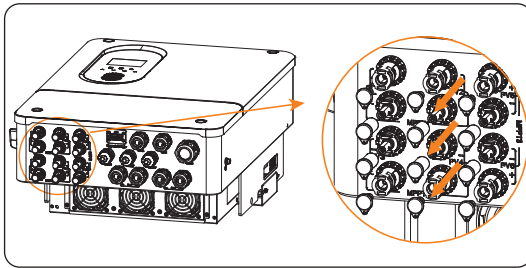

Figure 8-30 Removing the PV terminal caps

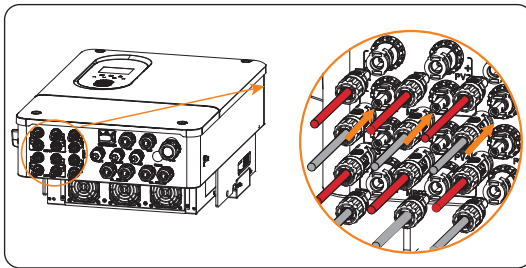

Figure 8-31 Connecting the PV cable

**NOTICE!**

- For 8 kW~10 kW inverters, remove PV terminal caps of MPPT1 and MPPT2.

**WARNING!**

- Seal the unused PV terminals with original terminal caps. If all PV terminals are connected, keep the waterproof caps in a safe place. Reinstall it immediately after removing the connectors from terminals.

## 8.5 Battery Power Cable Connection

### DANGER!

- Before connecting the cables, make sure the breaker, power button (if any) and DC switch (if any) of battery is OFF.
- Always ensure correct polarity. Never reverse the polarity of the battery cables as this will result in inverter damage.

### NOTICE!

- The power cable of battery is in the battery accessory pack. NOT in the scope of inverter's delivery.

### Requirements for battery connection

- Battery
  - » Lithium and Lead-acid battery
  - » The inverter is equipped with two independent battery terminals, allowing for connection to two separate battery strings.
  - » Make sure the input voltage of each BAT terminal is higher than minimum voltage 40 V and lower than maximum input voltage 60 V.
- Micro circuit breaker (MCB)
  - » If the battery is integrated with a readily accessible internal DC breaker, no additional DC breaker is required. If local regulations mandate the use of a DC MCB between the battery and the inverter, install a non-polar DC MCB.
  - » The nominal voltage of DC MCB should be larger than maximum voltage of battery.

Model	X1-Lite-8K-LV	X1-Lite-10K-LV	X1-Lite-12K-LV
Voltage	Nominal voltage of DC breaker should be larger than maximum voltage of battery.		
Current (A)	250	250	300

- Battery configuration information
  - » X1-Lite-LV series inverter matches with SolaX low voltage battery TP-LD53, TP-LD150. A single inverter can match with maximum 16 batteries.

Battery connection diagram

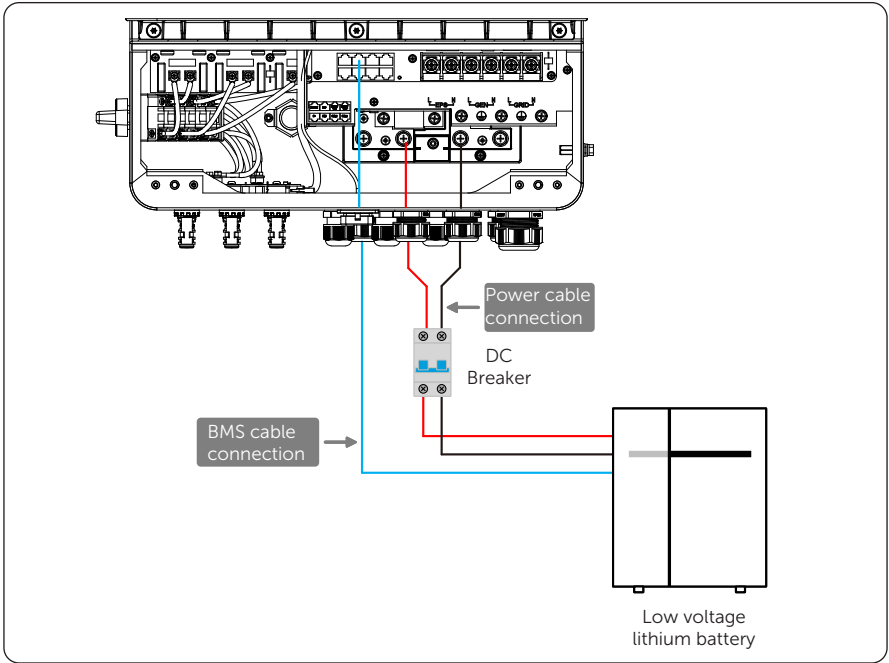

Figure 8-32 Lithium battery connection diagram

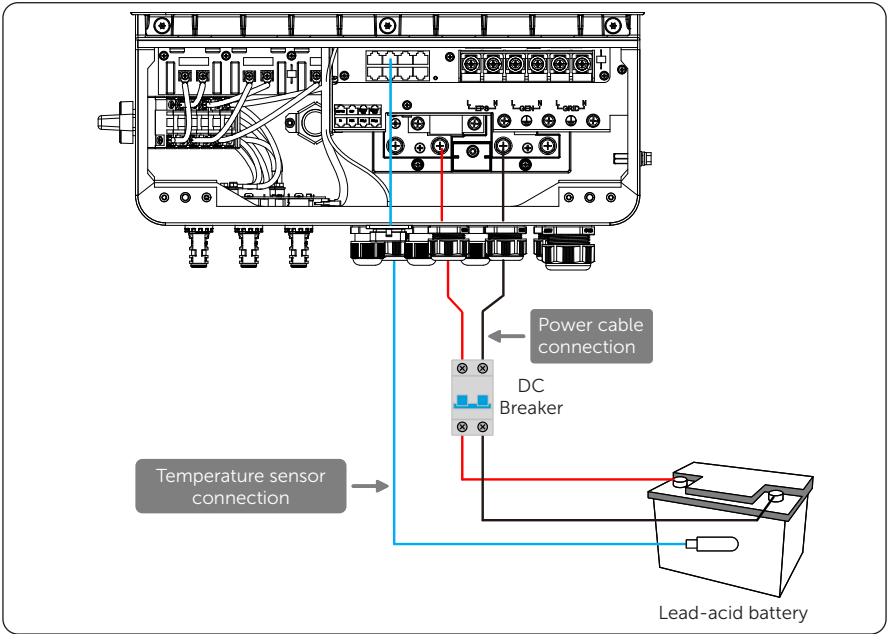

Figure 8-33 Lead-acid battery connection diagram

### Wiring procedures

**Step 1:** Strip the insulation of the battery power cable to an appropriate length.

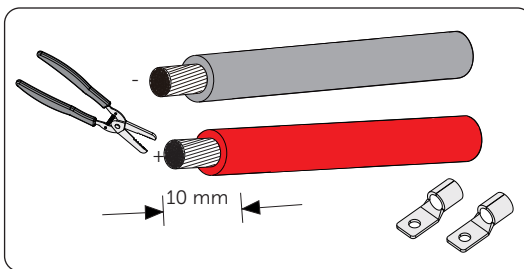

Figure 8-34 Stripping the battery cable

**Step 2:** Insert the stripped cable into the battery connection terminal (Part H). Use crimping tool for battery to crimp it.

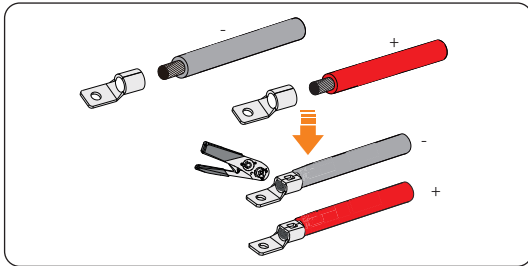

Figure 8-35 Inserting the battery connection terminal

**Step 3:** Disassemble the BAT+ and BAT- ports. Then remove the plug.

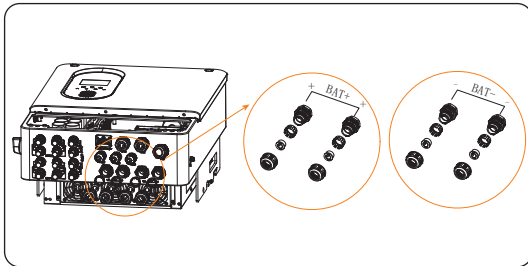

Figure 8-36 Disassembling the terminal

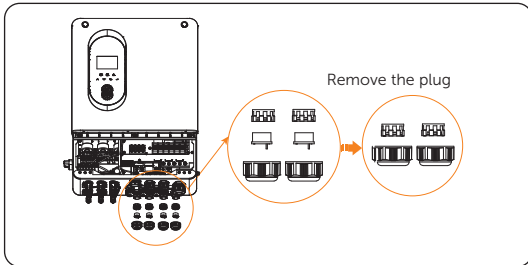

Figure 8-37 Removing the plug

**Step 4:** Thread the battery cable through swivel nut and the battery terminal.

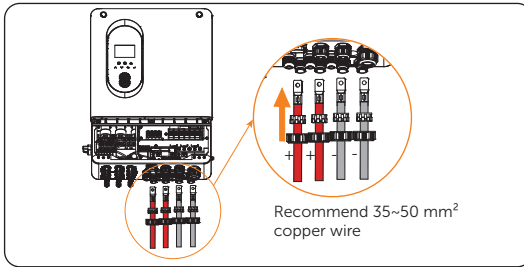

Figure 8-38 Removing the plug

**Step 5:** Remove the M8 screws to connect the battery cable. (Torque:  $5 \pm 0.5 \text{ N}\cdot\text{m}$ )

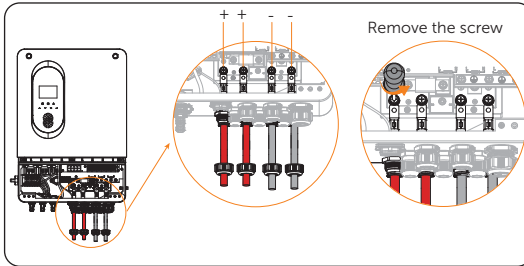

Figure 8-39 Removing the screws

**Step 6:** Insert the positive cable into BAT+ port and the negative cable to BAT-port. Use cross screwdriver to tighten the screws (Torque:  $5 \pm 0.5 \text{ N}\cdot\text{m}$ ). Then tighten the swivel nut. Verify that the battery connectors have the correct polarity before connection.

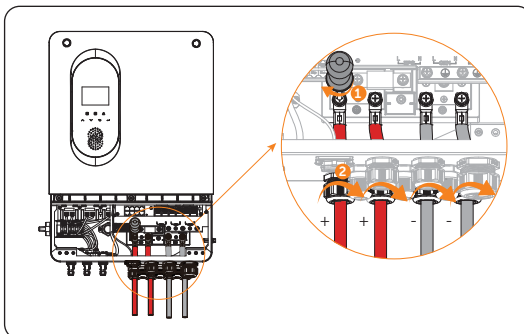

Figure 8-40 Connecting the battery connector

### Battery temperature sensor wiring procedures

- Step 1:** Find the battery temperature sensor (Part F) in the accessory bag.
- Step 2:** Disassemble the COM1/2/3 terminal. You can select any port from COM1/2/3. Pass the battery temperature sensor through the COM port and insert the RJ45 terminal of the battery temperature sensor into the BMS port located inside the inverter. Then attach the terminal of the other end to the lead-acid battery in order to measure the battery temperature.

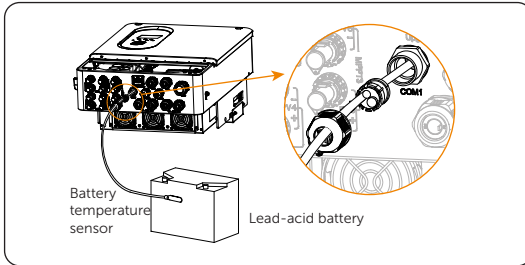

Figure 8-41 Disassemble the swivel nut and attaching the terminal

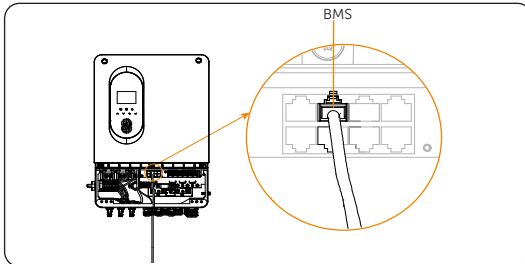

Figure 8-42 Inserting the cable into BMS port



## 8.6 COM Communication Connection

### 8.6.1 Pin Assignment of COM Terminal

The COM terminal is used for generator state detection, rapid shutdown and remote monitoring via DI/COM terminal, generator start-up via DO terminal, battery communication via BMS terminal, controlling the device response via DRM terminal, Meter and CT connection via METER/CT\_1 and METER/CT\_2 terminal, parallel connection via PAR\_1 and PAR\_2 terminal.

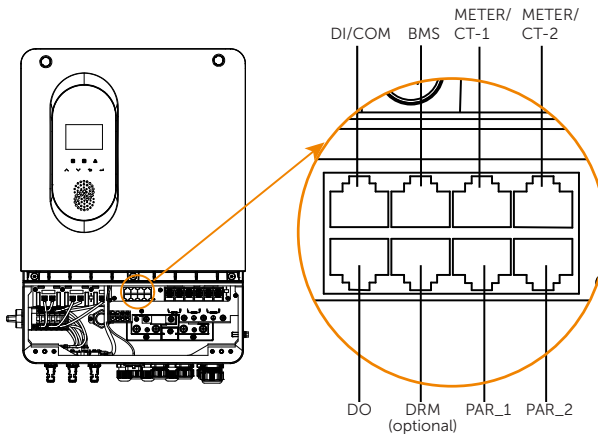

DI/COM	
1: DI_1	1
2: DI_2	2
3: /	3
4: RS485A	4
5: RS485B	5
6: GND	6
7: /	7
8: /	8

DO	
1: DO2_1	1
2: /	2
3: DO2_2	3
4: /	4
5: /	5
6: DO1_1	6
7: /	7
8: DO1_2	8

BMS	
1: BMS_485B	1
2: BMS_485A	2
3: GND	3
4: BMS_CANH	4
5: BMS_CANL	5
6: /	6
7: BMS_WAKEUP	7
8: BAT_TEMP	8

DRM	
1: DRM1/5	1
2: DRM2/6	2
3: DRM3/7	3
4: DRM4/8	4
5: RG/0	5
6: CL/0	6
7: /	7
8: /	8

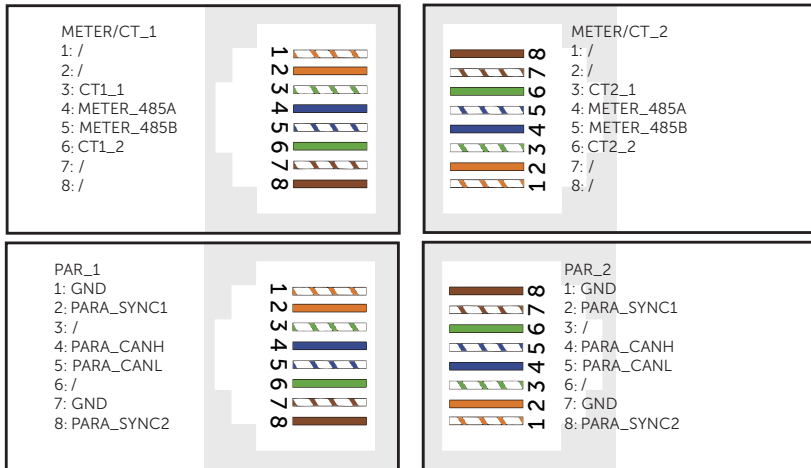

Figure 8-43 Pin assignment of COM terminal

### 8.6.2 DI/COM Connection

DI/COM terminal is designed to support generator state detection, rapid shutdown and remote monitoring through dry contact input.

To enhance safety and reduce the risk of injury, you can install the emergency stop switch in a readily accessible location through dry contact connection. In the event of an emergency, this switch can be easily reached and pressed to promptly switch off the entire system, ensuring a swift response and preventing further harm.

#### DI/COM pin assignment

Table 8-3 DI/COM pin assignment

	Pin	Pin assignment
For generator state detection or rapid shutdown (dry contact input)	1	DI_1
	2	DI_2
	3	/
For remote monitoring (dry contact input)	4	RS485A
	5	RS485B
	6	GND
	7	/
	8	/

### 8.6.3 DO Connection

DO terminal is designed to support generator start-up through dry contact output.

#### DO pin assignment

Table 8-4 DO pin assignment

	Pin	Pin assignment
	1	DO2_1
	2	/
	3	DO2_2
	4	/
	5	/
For generator start-up (dry contact output)	6	DO1_1
	7	/
For generator start-up (dry contact output)	8	DO1_2

### 8.6.4 BMS Communication Connection

Through BMS communication terminal, the inverter can communicate with the battery.

### 8.6.5 DRM Connection (Applicable to AS/NZS 4777.2)

According to AS/NZS 4777.2, the inverter needs to support the function of demand response mode (DRM). With the use of an external control box, active or reactive power regulation can be realized in a timely and fast manner, and the inverter can be operated stably during the process of regulation.

DRM 0, DRM 1 and DRM 5 are available now.

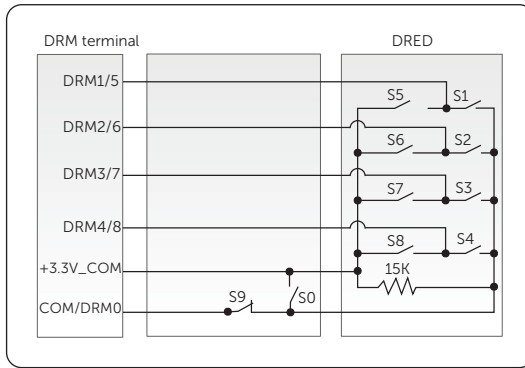

Figure 8-44 DRED connection diagram

Table 8-5 Descriptions of DRM

Mode	Pin	Requirement
DRM 0	Pin 6	<ul style="list-style-type: none"> <li>When S0 is turned on, the inverters shut down.</li> <li>When S0 is turned off, the inverters restore grid connection.</li> </ul>
DRM 1	Pin 1	<ul style="list-style-type: none"> <li>When S1 is turned on, the inverters do not input active power.</li> </ul>
DRM 5	Pin 1	<ul style="list-style-type: none"> <li>When S5 is turned on, the inverters do not output active power.</li> </ul>

### 8.6.6 Meter/CT Connection

The inverter should work with an electric meter or current transformer (CT for short) to monitor household electricity usage. The electricity meter or CT can transmit the relevant electricity data to the inverter or platform.

#### ⚠ CAUTION!

- Smart meters must be authorized by our company. Unauthorized meter may be incompatible with the inverter, thereby resulting in inverter damage and working mode malfunction. SolaX will not be responsible for the impact caused by the use of other appliances.

#### NOTICE!

- Do not place the CT on the N wire or ground wire.
- Do not put CT on the N wire and L wire at the same time.
- Do not place the CT on the side where the arrow points to the inverter.
- Do not place the CT on non-insulated wires.
- The cable length between CT and inverter should not exceed 100 meters.
- It is recommended to wrap the CT clip around in circles with insulating tape.

## Meter/CT connection diagram

## NOTICE!

- The following diagrams take SolaX authorized DTSU666 meter connection for example.
  - If you have other power generation equipment (such as an inverter) at home and wants to monitor both equipment, our inverter provides Meter 2 communication function to monitor the power generation equipment. For more information, please contact us.
  - Please make PE connection for Meter if the meter has ground terminal.
- Meter connection diagram

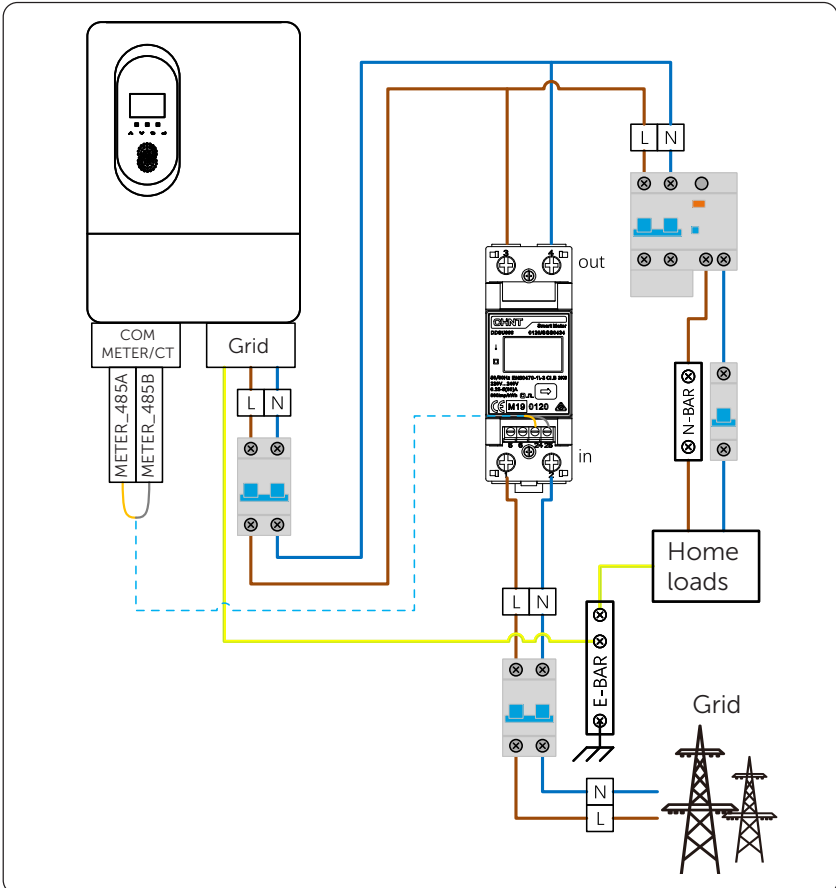

Figure 8-45 Meter connection diagram

- CT connection diagram

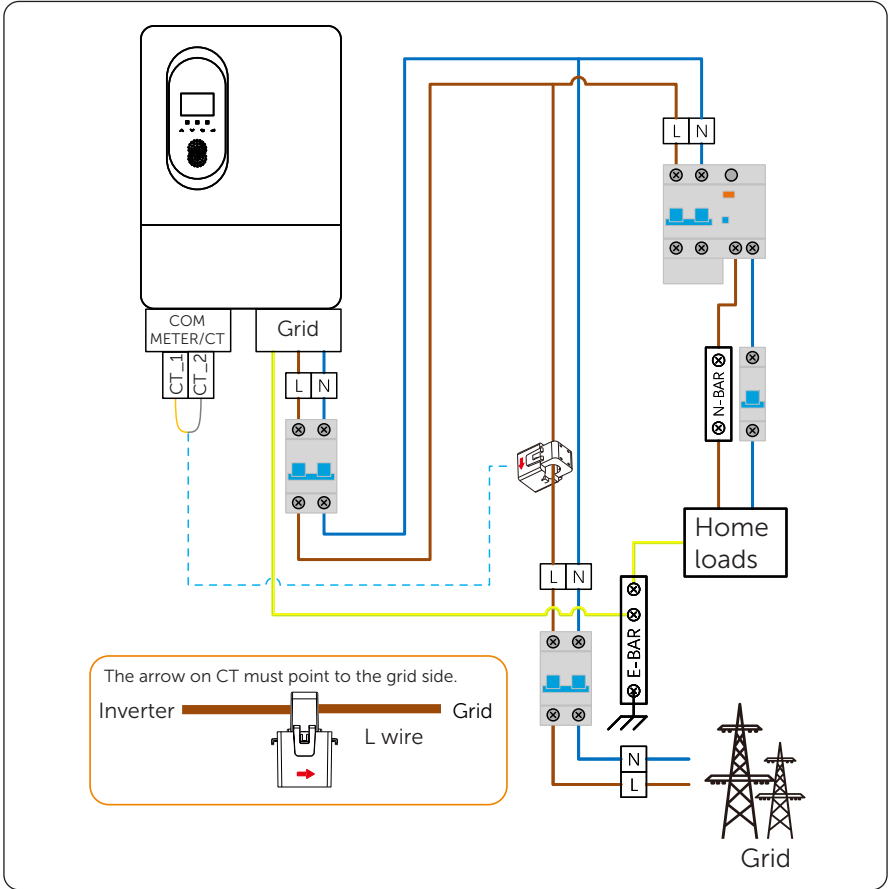

Figure 8-46 CT connection diagram

### Meter/CT\_1 pin assignment

	Pin	Pin assignment
	1	/
	2	/
For CT connection	3	CT1_1
For Meter connection	4	METER_485A
	5	METER_485B
For CT connection	6	CT1_2
	7	/
	8	/

### Meter/CT\_2 pin assignment

	Pin	Pin assignment
	1	/
	2	/
For CT connection	3	CT2_1
For Meter connection	4	METER_485A
	5	METER_485B
For CT connection	6	CT2_2
	7	/
	8	/

## 8.6.7 Parallel Connection

The inverter provides the parallel connection function. One inverter will be set as the **Master** inverter to control other **Slave** inverters in the system. For details, please refer to "15.1 Application of Parallel Function".

### 8.6.8 Wiring procedure of COM Communication Connection

#### Meter/CT wiring procedure

**Step 1:** Disassemble the COM port, then remove the plug. For communication connection, you can select any port from COM1/2/3. For unused terminals, keep the plug to protect the terminal.

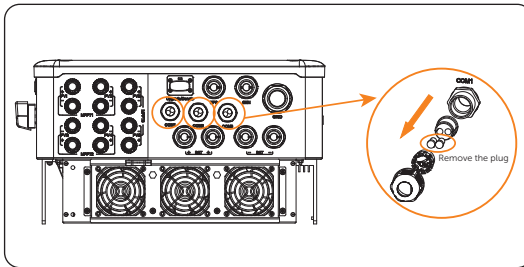

Figure 8-47 Removing the plug

**Step 2:** Crimp RJ45 terminal (Part P). It is recommended to use CAT5 network cable. For CT connection without RJ45 connector (Part Q), there is no need to crimp RJ45 terminal.

For Meter connection, crimp only one RJ45 terminal. (Step a, b)

For CT connection with RJ45 connector, crimp two RJ45 terminals. (Step a, b,c)

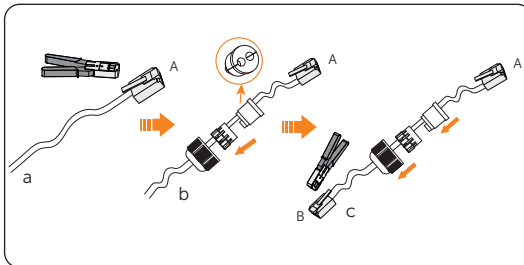

Figure 8-48 Crimping RJ45 terminal



**Step 3:** For Meter connection. Insert one side of the cable (with RJ45 terminal) into the Meter/CT port of the inverter, and the other side into the Meter. Then tighten the swivel nut.

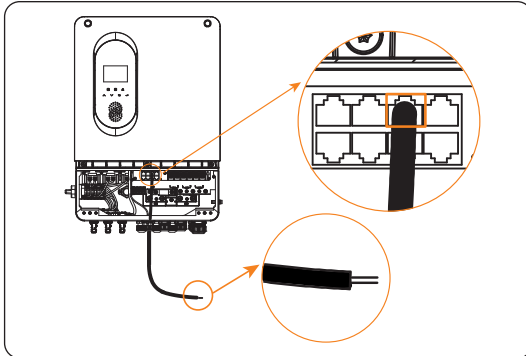

Figure 8-49 Inserting the cable into the Meter/CT port

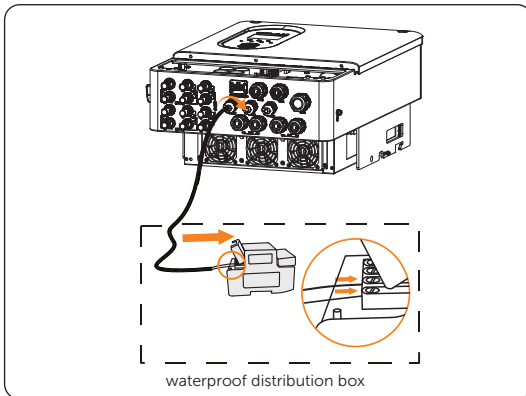

Figure 8-50 Inserting the cable into the Meter

**Step 4:** For CT connection without RJ45 connector. Insert the cable with RJ45 terminal side into the Meter/CT port of the inverter. Then tighten the swivel nut.

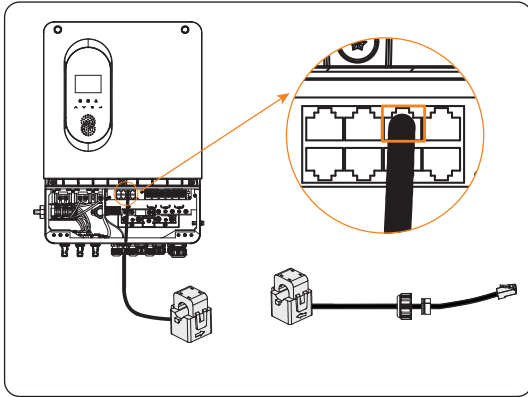

Figure 8-51 Inserting the cable into the Meter/CT port

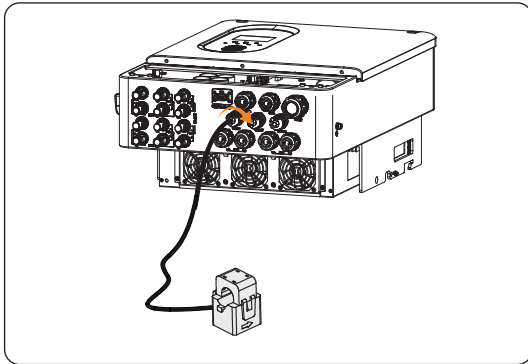

Figure 8-52 Tightening the swivel nut

**Step 5:** For CT connection with RJ45 connector. Insert one side of the cable into the Meter/CT port of the inverter, and the other side into the RJ45 connector. Then insert the RJ45 terminal of the CT into the RJ45 connector. Then tighten the swivel nut.

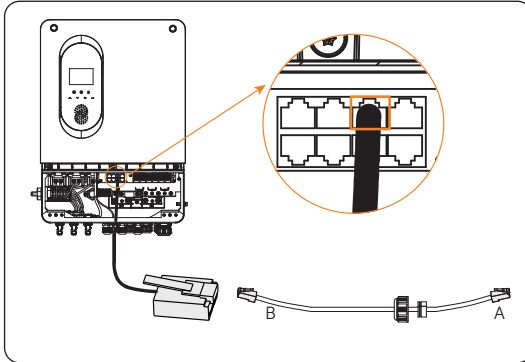

Figure 8-53 Inserting the cable into the Meter/CT port

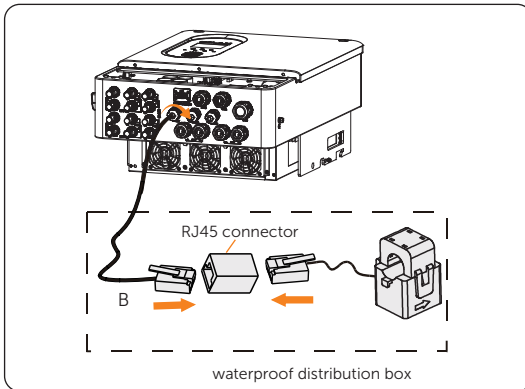

Figure 8-54 Inserting the RJ45 terminals into the RJ45 connector

### DI/COM, BMS, DO, DRM wiring procedure

**Step 1:** Thread the cable into the swivel nut, clamping jaw and cable support sleeve. Strip the insulation layer (length: 15mm) at one end of the cable. Crimp RJ45 terminal at the same end of the cable. Pay attention to the pin order of RJ45 terminal. Use a network cable tester to check if the cable has been correctly and properly crimped before connecting to inverter.

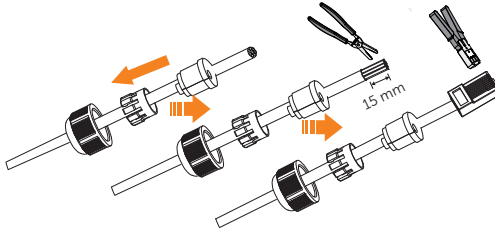

Figure 8-55 Cable making procedure

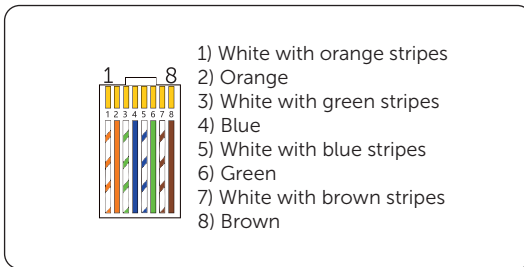

Figure 8-56 Pin order of RJ45 terminal

**Step 2:** For communication connection, you can select any port from COM1/2/3. Find the location of DI/COM, BMS, DO, DRM port inside the inverter.

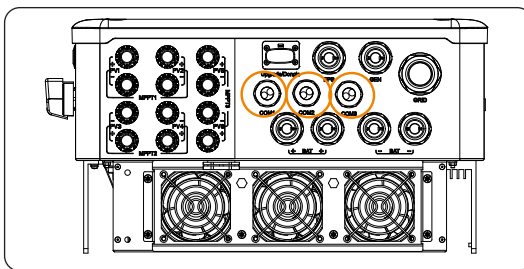

Figure 8-57 Finding the COM terminal

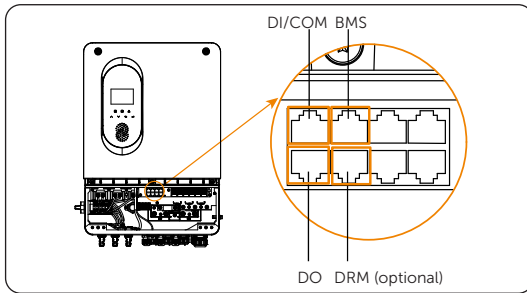

Figure 8-58 Finding the DI/COM, BMS, DO, DRM port

**Step 3:** Insert the assembled cable into the corresponding ports, then tighten the swivel nut.

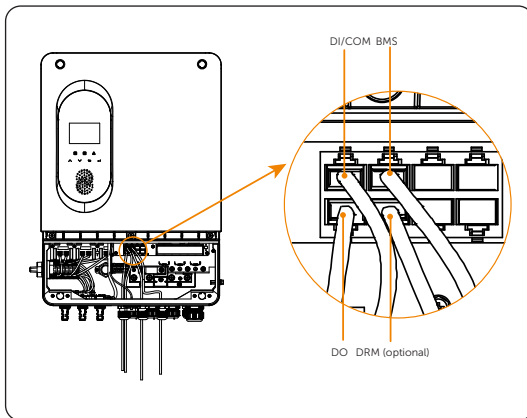

Figure 8-59 Connecting the DI/COM, BMS, DO, DRM port

Parallel wiring procedure

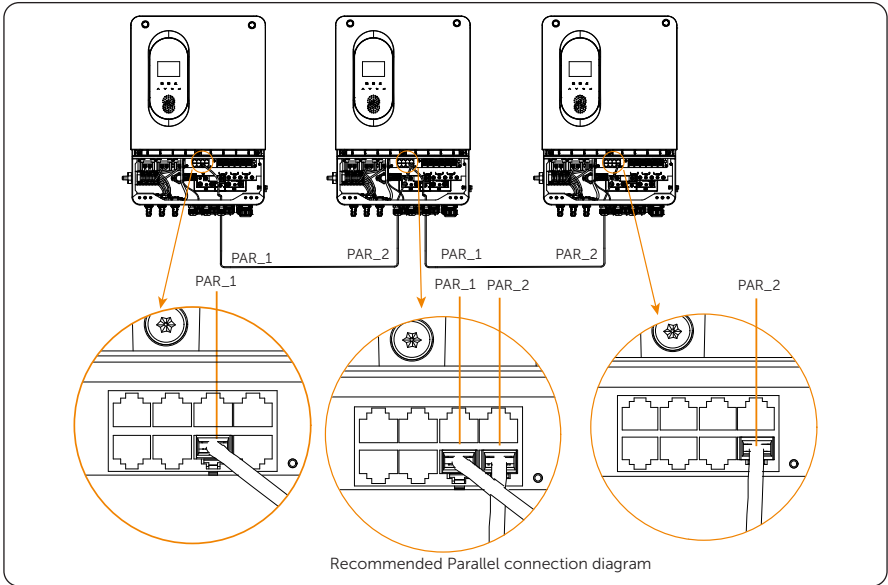

Figure 8-60 Parallel connection diagram

**NOTICE!**

- Parallel network cable is in the accessory bag.

### Close the lower cover

**Step 1:** Put the lower cover back to the inverter. Use cross screwdriver to tighten the screws on both sides. (Torque:  $3\pm 0.3$  N·m)

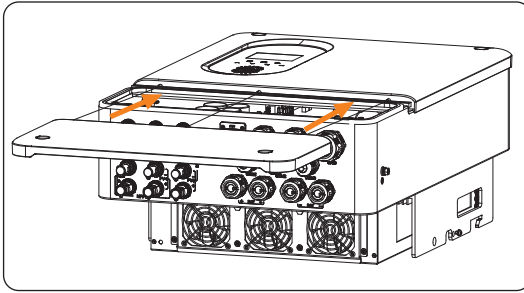

Figure 8-61 Put the lower cover back

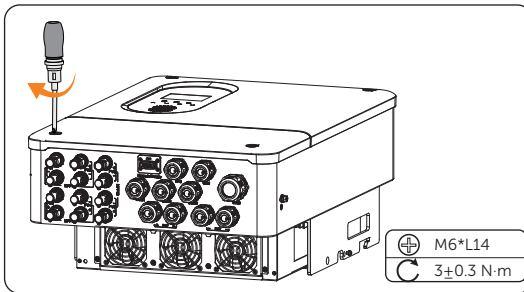

Figure 8-62 Tighten the screws

**Step 2:** Install the two decorative buckles (Part S) to the two screws from the accessory bag.

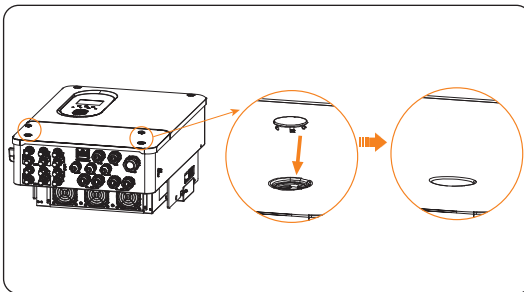

Figure 8-63 Installing the decorative buckles

## 8.7 Monitoring Connection

The inverter provides a Dongle terminal, which can transmit data of the inverter to the monitoring website via WiFi+LAN dongle (Optional). The WiFi+LAN dongle is equipped with two kinds of communication modes (Wi-Fi mode or LAN mode). Users can choose based on actual needs.

### Monitoring connection diagram

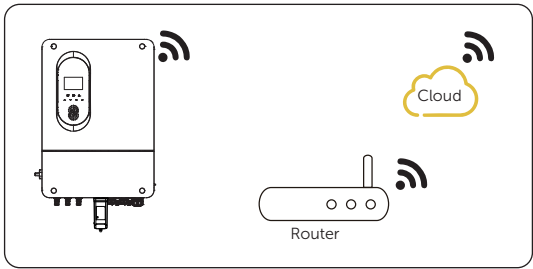

Figure 8-64 Wi-Fi mode connection diagram

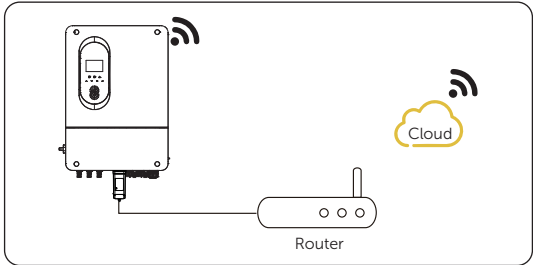

Figure 8-65 LAN mode connection diagram



## Monitoring wiring procedure

Wi-Fi mode:

- a. Assemble the dongle.

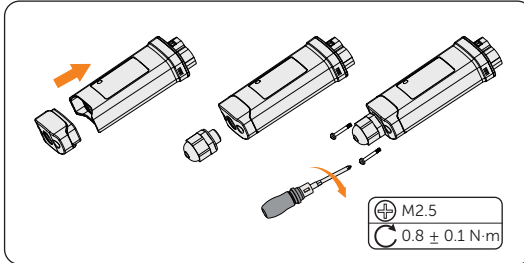

Figure 8-66 Assembling the dongle

- b. Plug the dongle to the inverter.

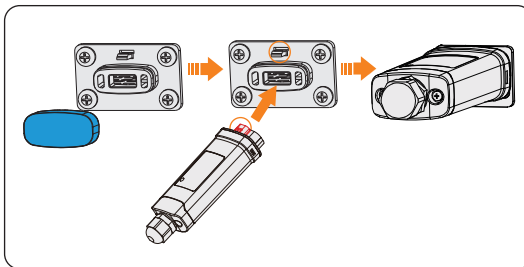

Figure 8-67 Dongle connection procedure

### CAUTION!

- The buckles on the inverter and dongle must be on the same side. Otherwise, the dongle may be damaged.

### NOTICE!

- The distance between the router and the inverter must be no more than 100 meters. If there are walls in between, the distance must be no more than 20 meters.
- For locations where Wi-Fi signals are weak, install a Wi-Fi signal booster.

### NOTICE!

- For details on Wi-Fi configuration, see *Pocket WiFi + LAN Installation Manual*. You can configure Wi-Fi only after the inverter is powered on.

LAN mode:

- a. Disassemble the waterproof connector into components 1, 2, 3 and 4; Component 1 is not used. Keep it in a safe place.

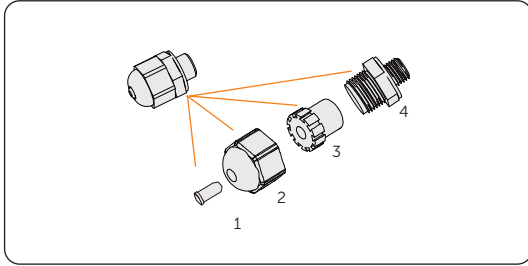

Figure 8-68 Disassembling the waterproof connector

- b. Assemble the dongle.

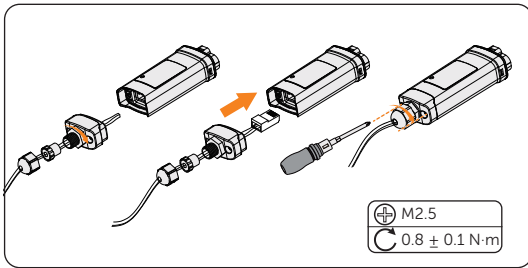

Figure 8-69 Assembling the dongle

- c. Plug the dongle to the inverter.

# 9 System Commissioning

---

## 9.1 Checking before Power-on

No.	Item	Checking details
1	Installation	The inverter is installed correctly and securely. The battery is installed correctly and securely. Other device (if any) is installed correctly and securely.
2	Wiring	All DC, AC cables and communication cables are connected correctly and securely; The meter/CT is connected correctly and securely. The ground cable is connected correctly and securely;
3	Breaker	All the DC breakers and AC breakers are OFF;
4	Connector	The AC and DC connectors are connected; The connectors on the Grid and EPS terminal are connected correctly and securely.
5	Unused terminal	Unused terminals and ports are locked by waterproof caps.
6	Screw	All the screws are tightened.

## 9.2 Powering on the System

**Step 1:** Turn on the AC breaker between the inverter and the public grid.

**Step 2:** Turn on the AC breaker between the inverter and the EPS loads.

**Step 3:** Turn on the DC switch between the PV string and the inverter. (if any)

**Step 4:** Turn on the DC switch between the battery and the inverter.

**Step 5:** Turn on the DC switch at the left side of the inverter.

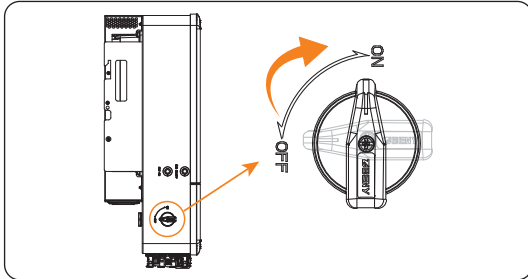

**Step 6:** If the battery is connected, but PV and Grid are not connected. Press and hold the battery button until the screen is on. If PV or Grid is connected, skip this step.

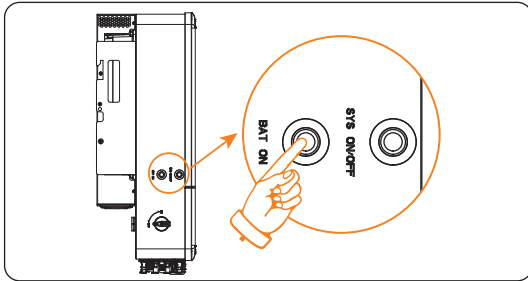

**Step 7:** Turn on the system button at the left side of the inverter, the light on the system button will light up. Then the inverter will start automatically.

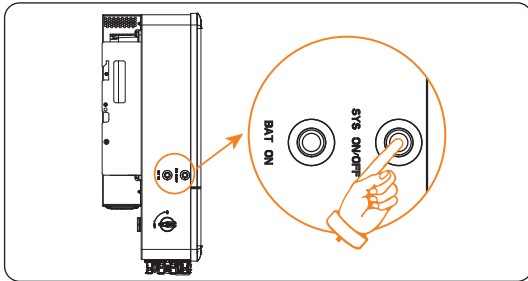

# 10 Operation on LCD

## 10.1 Introduction of Control Panel

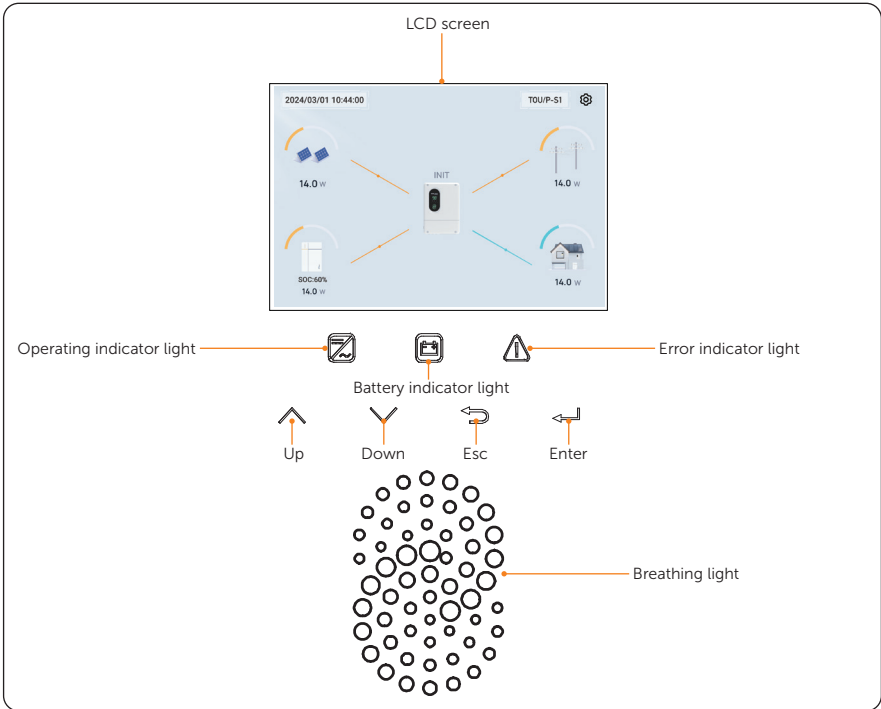











Figure 10-1 Control Panel

- While upgrading, the green, blue and red indicator lights will flash in turns and the breathing light also flashes the three colour in turns, indicating that the upgrade is in progress.
- In error state, an error alarm will be displayed at the LCD screen, please check the information and refer to corresponding solutions in the troubleshooting.

Item	Definition
LCD screen	Display the information of the inverter. You can tap on the icons to check and reset the parameters.

Table 10-1 Definition of indicators

LED indicator	Status	Definition
 Operating	 Solid green	The inverter is in grid-connected operation state or off-grid operation state.
	 Green blinking	The inverter is in the process of powering on.
	 Light off	The inverter is in a fault or manual shutdown state.
 Battery	 Solid blue	One battery is connected in a normal state at least.
	 Light off	Low battery voltage or no battery.
 Error	 Solid red	The inverter is in a fault state.
	 Light off	The inverter has no faults or alarms.





Breathing light	Status	Definition
 Breathing light	 Green blinking	Both inverter and battery are in normal status.
	 Red blinking	The inverter or battery has alarm information or fault.
	 Blue blinking	The battery is in normal status, but the battery SOC is lower than the setted Min SOC.
	Green, blue and red lights flash in turns	The upgrade is in progress. After successfully upgraded, the light turns green and the buzzer sounds for one second.

Table 10-2 Definition of keys

Key	Definition
ESC key	Return to the superior menu or cancel setting value.
Up key	Turn to the previous page.
Down key	Turn to the next page.
Enter key	Confirm the selection.

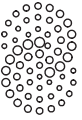
## 10.2 Introduction of Menu Interface

The default menu is shown as below. In this interface, you can tap on the four icons of PV, battery, grid and load to check the basic information of each part.



- Inverter: You can **Power ON/OFF** the inverter after tapping the icon of the inverter. Information contains the inverter voltage, inverter current, inverter power, input/export electric energy of the inverter today and total input/export electric energy since the inverter activated for the first time (Positive value means power output; Negative value means power input).

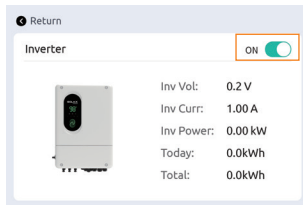

- PV: Display the PV information of the system, containing input voltage, current and power situation of each MPPT.

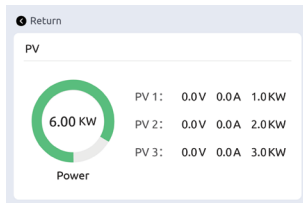

- Battery: Display the information of battery. Information contains the power, voltage, current, temperature and SOC status. Tap the **BMS detail** (Only available for SolaX Lithium battery), you can see the battery's SN number and Version.

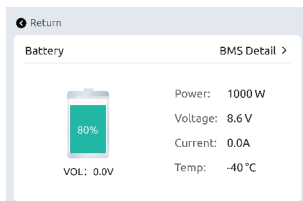

- Grid: Information contains the voltage, current, output power, and frequency of Grid terminal. And information of feed-in and consumption power today and total.



- Load: Information contains the total load, the voltage, current and frequency of load.

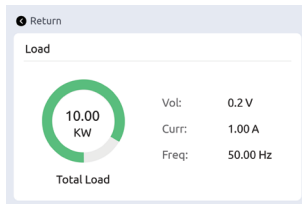

- Settings: After tapping the setting icon on the upper right corner, you can enter the submenus interface. There are eight submenus in the menu that can be selected for relevant setting operations.

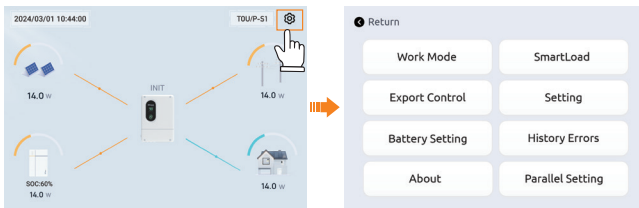

- » **Work Mode:** Select the working mode of the inverter, including Work mode for Pakistan : **SUB, SBU, MKS/EPS and Force Time Use** and Work mode for other countries: **Back Up, Self Consumption and Force Time Use**.

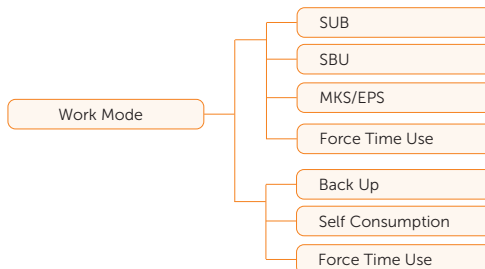



- » **Export Control:** Set whether or not feeding power to the grid (Including **No Export** and **Export**) and **Max Utility Charge Current**.

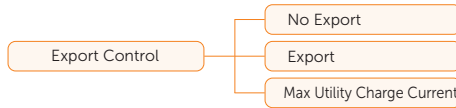

- » **Battery Settings:** Select **Battery Type** and set **Charge Source**.

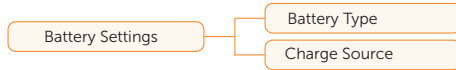

- » **About:** Here you can see some basic information of the inverter.
- » **Smart Load:** Set the generator port connections including: **None**, **Load** and **Generator**.

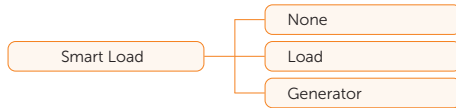

- » **Setting:** Set the parameters of the inverter, including **Basic** and **Advance**.

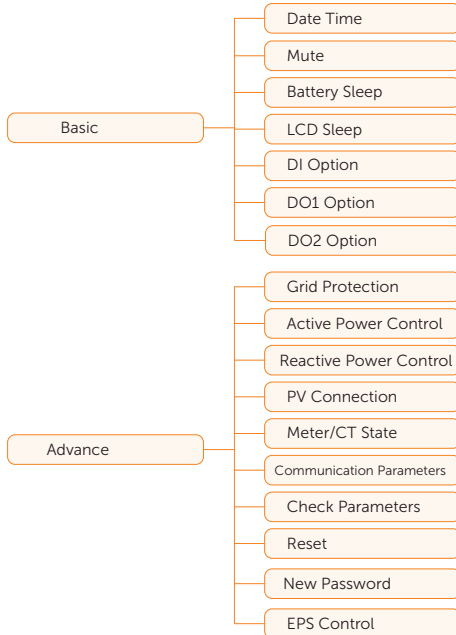

- » **History Errors:** Display the history data of errors.
- » **Parallel Setting:** Set the parameters of parallel.

### 10.3 Work Mode

Please refer to "2.7 Working Mode" for introduction and working logic of the work modes.

Setting path:  > **Work Mode**

After entering into the default menu, select the **Setting icon**, then you can set work mode for Pakistan and work mode for other countries as follows:

#### Work Mode for Pakistan

To select the Pakistan work modes, please tap "Country" on the **Basic** interface (**Inverter** > **Setting** > **Basic**) and select "Pakistan" first. You can refer to "Country" section for details. There are four work modes for Pakistan: **SUB**, **SBU**, **MKS/EPS** and **Force Time Use**.

- **SUB**

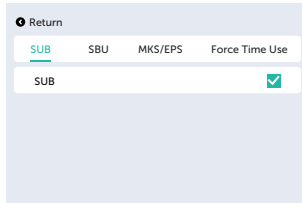

- **SBU**

- » **Return to Utility Voltage/SOC:** When the voltage/SOC is lower than the setted value, the battery starts to charge.  
(For lead acid battery) Default: 46 V, range: 42~47 V;  
(For Lithium battery) Default: 20%, range: 10~75%.
- » **Return to Battery Voltage/SOC:** When the voltage/SOC is higher than the setted value, the battery starts to discharge.  
(For lead acid battery) Default: 54 V, range: 48~59 V;  
(For Lithium battery) Default: 80%, range: 25~90%.

The minimum difference between the above two parameters is 2 V for lead acid battery and 5% for Lithium battery.

- » **Charge to Full** (only for lead acid battery): Disabled by default. When enabled, the battery will be charged to full capacity first without discharging.

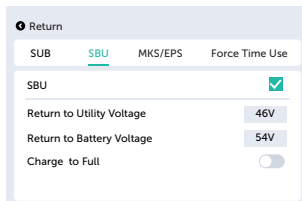

- **MKS/EPS**

- » **Return to SUB Mode:**  
(For lead acid battery) Default: 42.0 V, range: 40.0~56.0 V;  
(For Lithium battery) Default: 20%, range: 10~80%.
- » **Return to SBU Mode:**  
(For lead acid battery) Default: 58.0 V, range: 44.0~58.0 V  
(For Lithium battery) Default: 100%, range: 25~100%.

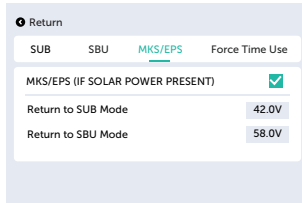

- **Force Time Use**

- » **Charge Period:** You can set three charge periods (start time and end time) here and set the charge source (**PV Only**, **PV Then Grid**, **PV and Grid**).
- » **Home Load Removed From Utility Time Periods:** You can set three discharging periods here.
- » **Battery Stop Discharge VOL/SOC:** When the battery voltage/SOC is lower than the set value, the battery will stop discharging.  
(For lead acid battery) Default: 43.0 V, range: 42.0~47.0 V  
(For Lithium battery) Default: 10%, range: 5~40%.

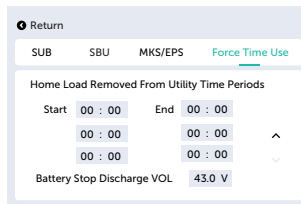
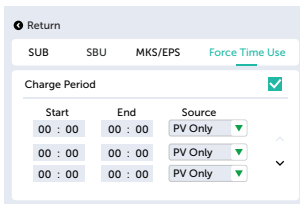

### Work Mode for other countries

There are three work modes for other countries: **Back Up**, **Self Consumption** and **Force Time Use**.

- **Back Up**

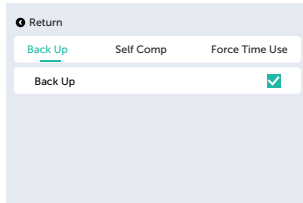

- **Self Consumption**

- » **Battery or Load First:** There are three options: **Self Comp**, **Battery First** and **Load First**.
- » **Return to Utility Voltage/SOC:** When the voltage/SOC is lower than the setted value, the battery starts to charge.  
(For lead acid battery) Default: 46 V, range: 42~47 V;  
(For Lithium battery) Default: 20%, range: 10~70%.
- » **Return to Battery Voltage/SOC:** When the voltage/SOC is higher than the setted value, the battery starts to discharge.  
(For lead acid battery) Default: 54 V, range: 48~59 V;  
(For Lithium battery) Default: 80%, range:20~90%.

The minimum difference between the above two parameters is 2 V for lead acid battery and 5% for Lithium battery when **Self Comp** is selected.

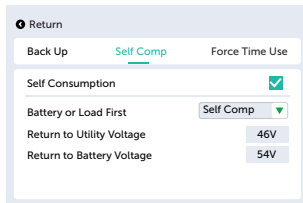

- **Force Time Use**

For most countries, the setting interfaces are as below:

- » **Charge Period:** You can set three charge periods (start time and end time) here and set the charge source (**PV Only**, **PV Then Grid**, **PV and Grid**).
- » **Discharge Period:** You can set three discharging periods here.
- » **Battery Stop Discharge:** When the battery voltage/SOC is lower than the set value, the battery will stop discharging.  
(For lead acid battery) Default: 43.0 V, range: 42.0~47.0 V  
(For Lithium battery) Default: 10%, range: 5~40%.

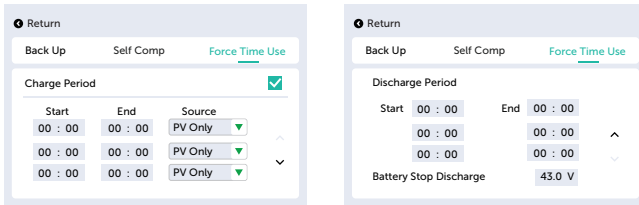

For Vietnam, the setting interfaces are slightly different with more parameters to be set. You can select to set each **Charge Period** and **Discharge Period**. Except start time, end time and charging source for charge period, and start time, end time for discharge period, the following can be set:

- » **Charge Stop VOL/SOC:** When the battery voltage/SOC is higher than the set value, the battery will stop charging.  
(For lead acid battery) Default: 58.0 V, range: 47.0~60.0 V  
(For Lithium battery) Default: 99%, range: 20~99%.
- » **Max Charge Power:** Maximum allowable charging power. Default: 6000 W, range: 1~12000 W.
- » **Discharge Stop VOL/SOC:** When the battery voltage/SOC is lower than the set value, the battery will stop discharging.  
(For lead acid battery) Default: 42.0 V, range: 40.0~52.0 V  
(For Lithium battery) Default: 10%, range: 10~40%.
- » **Max Discharge Power:** Maximum allowable discharge power. Default: 6000 W, range: 1~12000 W.

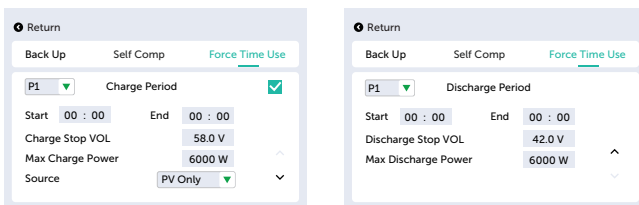

## 10.4 Export Control

Setting path: > **Export Control**

Here users can choose between feeding excess PV power into the grid or limiting it.

- **No Export:** Disallow feeding power into the grid.
  - » **Device Bias Power:** The inverter will be biased to take power from the grid. Default: 0 W; Range: 0 W ~ 2% rated output power.
- **Export:** Allow feeding power into the grid and enables to set the percentage of power to be fed in as needed. Range: 0~100%
- **Max Utility Charge Current:** Setting the current that can be taken from the power grid when the battery is charged. Default: 20 A; Range: 0~250 A.

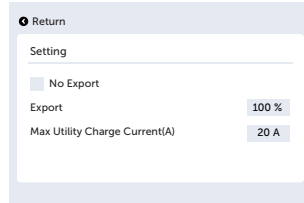
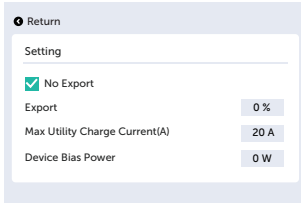

## 10.5 Battery Setting

Setting path: > **Battery Setting**

- **Battery Type:** Select the battery type according to the actual battery used.

Country	Battery type	Option
Pakistan	Lead Acid	AGM, FLD, TBL
	Lithium	SolaX-LV, Pylon, Volta, Lemoen, Lanni, Soluna
	User	User (User defined)
Other countries	Lead Acid	Lead Acid
	Lithium	SolaX-LV, Pylon, Volta, Lemoen, Lanni, Soluna
	User	User (User defined)

Touch the corresponding Battery type to enter the next level. Select from the options (if any) on the upper right and then touch the square on the right side of the displayed option to confirm the selection.

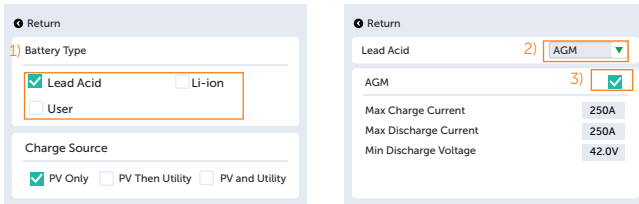

After that, you can set the relative parameters.

» Lead acid battery:

**Max Charge Current:** Default: 250 A, range: 2~250 A

**Max Discharge Current:** Default: 250 A, range: 2~250 A

**Min Discharge Voltage:** Default: 42.0 V, range: 40.0~47.0 V

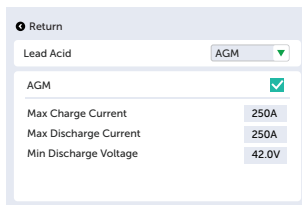

» Lithium battery:

**Max Charge Current:** Default: 250 A, range: 2~250 A

**Max Discharge Current:** Default: 250 A, range: 2~250 A

**Bat Online Cnt:** Display the number of batteries connected.

**Battery Parallel Mode** (Only for SolaX-LV): Set up the battery parallel mode.

**Alone:** Each battery is connected to the inverter separately. **Converge:** All the batteries is converged to the BMS.

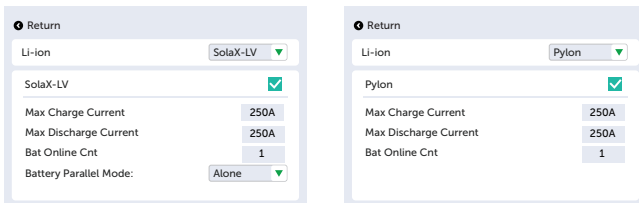

- » User: Here you can set the parameters of the battery according to your actual needs.

**Max Charge Voltage:** Default: 58.8 V, range: 49.0~60.0 V

**Min Discharge Voltage:** Default: 42.0 V, range: 40.0~47.0 V

**Float Charge Voltage:** Default: 54.4 V, range: 49.0~59.0 V

**Max Charge Current:** Default: 250 A, range: 2~250 A

**Max Discharge Current:** Default: 250 A, range: 2~250 A

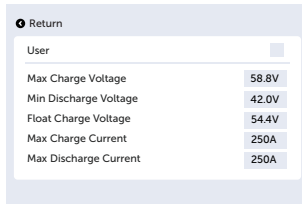

- **Charge Source:** For charging the battery, there are three options to choose from: PV Only, PV Then Utility and PV and Utility.
  - » **PV Only:** allows only PV charging.
  - » **PV Then Utility:** prioritizes PV charging and supplements with grid charging when needed.
  - » **PV and Utility:** allows for both PV and grid charging.

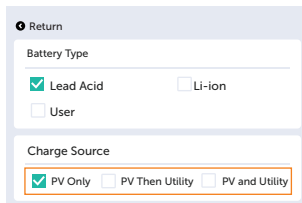

## 10.6 About

Setting path: ->About

Here you can check the basic information of the inverter.





## 10.7 Smart Load

Setting path:  > **Smart Load**

The generator port has three options:

- **None:** No device is connected to the generator port;

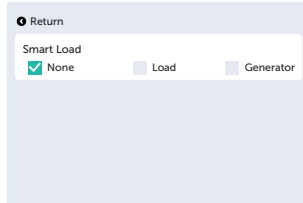

- **Load:** The generator port is connected to a load;

There are two types of Battery: Lead acid (Voltage type) and Lithium (SOC type).

- » **Smart Load Battery off Voltage/SOC:** When the voltage/SOC is lower than the setted value, the battery will no longer supply power to the smart load;
- » **Smart Load Battery on Voltage/SOC:** When the voltage/SOC is higher than the setted value, the battery will supply power to the smart load again.

**Smart Load Battery off Voltage:** Default: 48.0 V, range: 40.0-52.0 V

**Smart Load Battery on Voltage:** Default: 52.0 V, range: 41.0-53.0 V

**Smart Load Battery off SOC:** Default: 30%, range: 15-30%

**Smart Load Battery on SOC:** Default: 50%, range: 30-60%

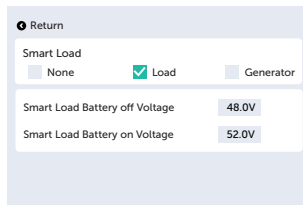

- **Generator:** The generator port is connected to the generator. For the details, please refer to "[15.2 Application of Generator](#)".

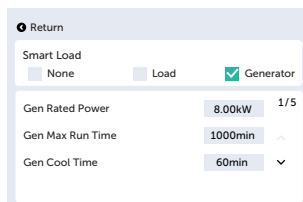

## 10.8 Setting

Settings includes Basic setting and Advance setting.

### 10.8.1 Basic Setting

Setting path:  > **Setting** > **Basic**

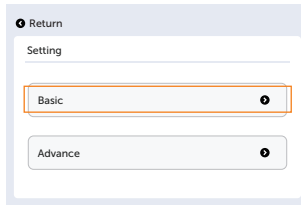

You can set **Country**, **Grid Code**, **Language**, **Mute**, **Battery Sleep**, **Lcd Sleep**, **Date Time**, **DI Option**, **DO1 Option** and **DO2 option** in **Basic** interface.

### Setting Safety Code

#### NOTICE!

- The inverter cannot be connected to the grid before the safety code is correctly set. If there is any doubt about your safety code where the inverter installed, please consult your dealer or SolaX service for details.
- The setup will vary from different safety codes.

You can set safety code according to different countries and grid-tied standards.

- **Setting Country**

This inverter provides multiple countries for customers to choose from according to the installation site.

- **Setting Grid Code**

After the **Country** is set, select the applicable **Grid Code**.

There are several standards to choose from, please refer to the LCD screen on the inverter. (May be changed or added without notice.)

In addition, the inverter has a user defined option which allows you to customize relevant parameters with a wider range. You can select: **Basic>Country>OTHER** and **Basic>Grid Code>USER\_DEFINED**. Then complete the parameter settings under **Advance** interface as needed.

### Setting Language

You can set the display language.

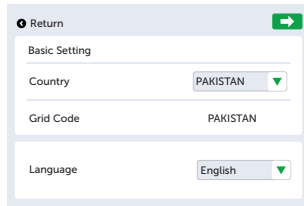

### Setting Off-Grid Mute

When the inverter is running in off-grid (EPS) Mode, you can choose whether the buzzer is turned on or not.

- Turn ON, the buzzer mutes.
- Turn off, the buzzer will sound every 4 seconds when the battery SOC is > EPS min. SOC. When the battery SOC is equal to EPS min. SOC, the buzzer will sound with higher frequency at every 400 ms.

### Setting LCD Sleep

You can set whether to enable the LCD Sleep function or not.

LCD Sleep state means if you do not operate the screen for a period of time, the screen will stay off.

### Setting Battery Sleep

You can set whether to enable the battery sleep function or not.

Battery Sleep state means the battery is in standby state. At this time, it will neither charge nor discharge.

### Setting Date Time

You can set the current date and time of the installation site.

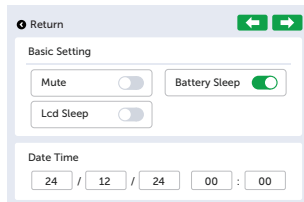

### Setting DI Option

You can set whether to enable the DI Option or not. **None** means disable the function. **Emerg Stop** means enable the function for emergency stop.

### Setting DO1 Option

You can set whether to enable the DO1 Option or not. **None** means disable the function. **Generator** means enable the function to allow communication with the generator.

### Setting DO2 Option

You can set whether to enable the DO2 Option or not. **None** means disable the function.

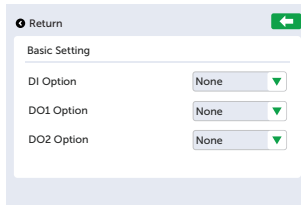

## 10.8.2 Advanced Setting

Setting path: ⚙️>**Setting**>**Advance**

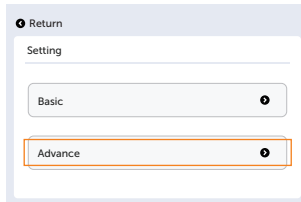

After tapping the **Advance** interface, you need to enter the password, the default password is "2014".

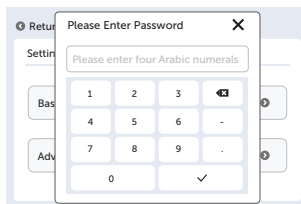

After entering into the **Advance** interface, you can set **Grid Protection**, **Active Power Control**, **Reactive Power Control**, **PV Connection**, **Meter/CT State**, **Com-Parameters**, **Check Parameters**, **Reset**, **New Password** and **EPS Control** here.

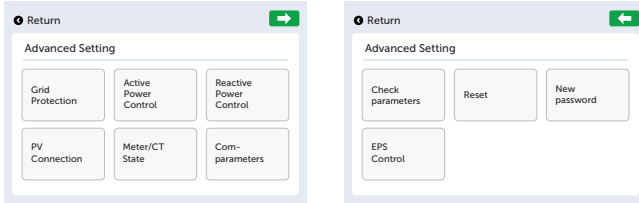

## Setting Grid Protection

When the safety code is selected, the parameters of **Grid Protection** corresponding to the selected safety code will be automatically matched. The default value is the specified value under the current safety regulations. The contents will be displayed according to the requirements of local laws and regulations.

You can also set the parameters according to your actual needs within the range of the specific safety code.



## Setting Active Power Control

Here you can set the **Power Limit** and **Power Slope** of the active power.

- » **Power Limit:** Default: 100%, Range:0~110%.
- » **Power Slope:** Default: 10.0%, Range:1.0~100.0%

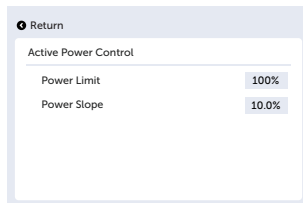

### Setting Reactive Power Control

There are four modes can be selected: **PF Mode**, **Fix Q Power**, **PF\_P Mode** and **Q(U) Mode**. The default value is the specified value under the current safety regulations. The contents will be displayed according to the requirements of local laws and regulations. Please refer to local grid requirements.

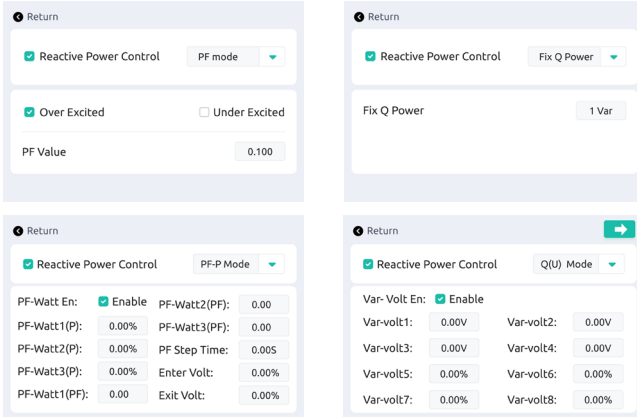

### Setting PV Connection

Here you can set PV connection mode.

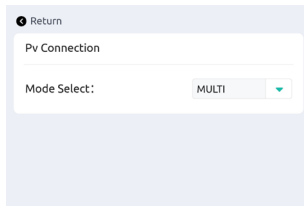

### Setting Meter/CT State

#### NOTICE!

- If the user has other power generation equipment (such as inverter) at home and wants to monitor both, the inverter provides Meter/CT\_2 communication function to monitor the power generation equipment.

Here you can set **Meter/CT1 State** and **Meter/CT2 State** based on the actual application.

**CT1** is enabled by default in **Meter/CT1 State**. **None** is set by default in **Meter/CT2 State**. If need to change, select from the upper right and for CT and Meter you need to touch the small square to confirm the selection.

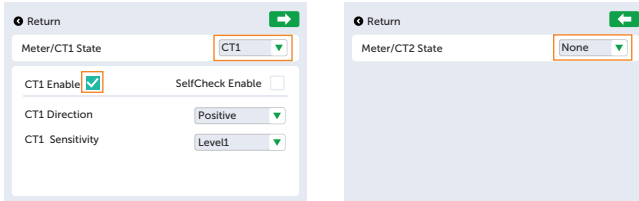

Below screen displays will take **Meter/CT1 State** as examples to describe the parameters. The parameters are basically the same.

- **CT:** The Meter/CT port is connected to CT;
  - » **CT1/2 Direction:** Here you can set the direction of CT1/2 to **Positive** or **Negative** connection according to the actual situation.
  - » **CT1/2 Sensitivity:** Here you can set the sensitivity level of CT1/2. There are three levels to choose from: **Level1** / **Level2** / **Level3**. The larger the number, the higher the sensitivity.
  - » **SelfCheck Enable:** After touching the square to enable this function, you need to enable **Self Check** to start the checking process. After checking, there will be an alarm about CT if anything abnormal is detected; please check the CT connection and try self checking again.

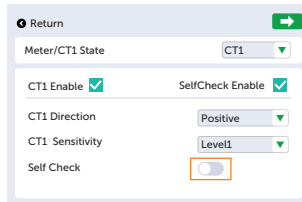

- **Meter:** The Meter/CT port is connected to Meter;
  - » **Meter1/2 Direction:** Here you can set the direction of Meter1/2 to **Positive** or **Negative** connection according to the actual situation.

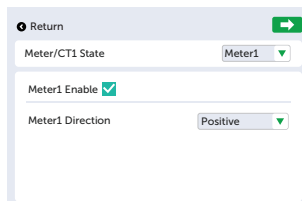

- **None:** No meter or CT is connected to the Meter/CT port.

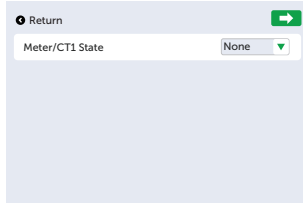

### Setting Com-parameters

You can select the baud rate and set the address of the external communication protocol for communicating with external equipment.

- » **Ex485 Modbus Baudrate:** Default: 9600. Range: 4800, 9600, 19200.
- » **Ex485 Modbus Address:** Default: 1. Range:1~127

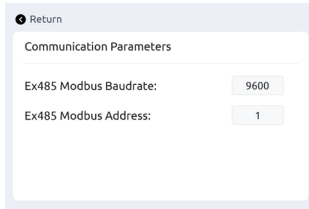

### Setting Check Parameters

Here you can set whether enabling or disabling the following check parameters: **AI\_En** (Active islanding detection) and **ExFanCheck\_En** (External fan fault detection).

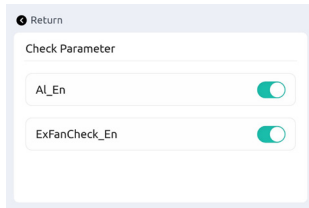



## Setting Reset

Here you can reset value of Comm Module and Meter1/CT1, Meter2/CT2; clear history record and energy records ; and restore to the factory set.

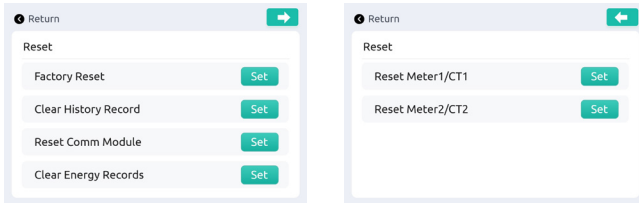

## Setting New password

Here you can reset the advanced password.

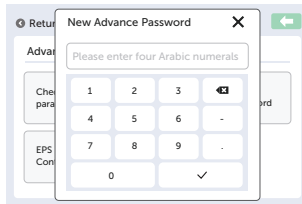

## Setting EPS Control

Here you can set the battery min. SOC in off-grid (EPS) mode for lithium batteries.

- » **Min SOC:** If the battery SOC falls below this value, the battery will stop discharging. Default: 10%. Range: 10%~25%.
- » **ESC Min SOC:** If the battery SOC reaches this value, the battery can restart to discharge. Default: 20%. Range: 15%~100%.

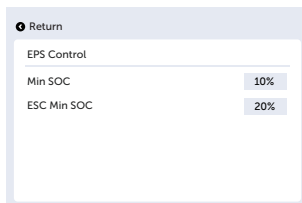

## 10.9 History Errors

Displaying path:  > **History Errors**

After entering the **History Errors** interface, the data of history errors will be displayed on the LCD. Information contains error code, error description and the date and time the error happened. Twenty records can be displayed at most.

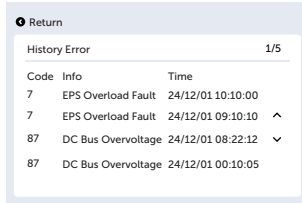



History Error			1/5
Code	Info	Time	
7	EPS Overload Fault	24/12/01 10:10:00	
7	EPS Overload Fault	24/12/01 09:10:10	^
87	DC Bus Overvoltage	24/12/01 08:22:12	v
87	DC Bus Overvoltage	24/12/01 00:10:05	

## 10.10 Parallel Setting

Setting path:  > **Parallel Setting**

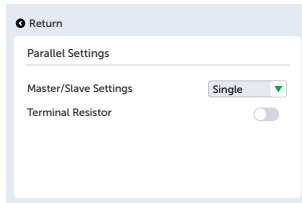
The series inverters support up to 10 units in the parallel system. The default setting is **Single**, if the inverters are to work in parallel the relative settings must be done. For details of the application of parallel function, please refer to ["15.1 Application of Parallel Function"](#).



Parallel Settings	
Master/Slave Settings	Single 
Terminal Resistor	<input type="checkbox"/>

# 11 Operation on SolaX App and Web

---

## 11.1 Introduction of SolaXCloud

SolaXCloud is an intelligent management platform for home energy, which integrates energy efficiency monitoring, device management, data security communication and other integrated capabilities. While managing your home energy device, it helps you optimize the efficiency of electricity consumption and improve the revenue of power generation.

## 11.2 Operation Guide on SolaXCloud App

### 11.2.1 Downloading and Installing App

Method 1: Select and scan the QR code below to download the app.



Figure 11-1 QR code for downloading SolaXCloud App

Method 2: Search for **SolaXCloud** iPhone APP Store, Google Play or Appstore of Android phones, and then download the app.

### 11.2.2 Operations on App

For instructions on related operations, see the online App guide, Wifi connection guide and Setup tutorial video on the SolaXCloud App.

## 11.3 Operations on SolaXCloud Webpage

Open a browser and enter [www.solaxcloud.com](http://www.solaxcloud.com) to complete registration, login, add site and other related operations according to the guidelines of User guide.

# 12 Troubleshooting and Maintenance

## 12.1 Power off

- a. Turn off the system button at the left side of the inverter.
- b. Turn off the DC switch at the left side of the inverter.
- c. Turn off the DC switch between the battery and the inverter and turn off the battery.
- d. Turn off the DC switch between the PV string and the inverter. (If there is any).
- e. Turn off the AC breaker between the inverter and the EPS loads.
- f. Turn off the AC breaker between the inverter and the public grid.

### WARNING!

- After the inverter is powered off, there may still be residual electricity and heat which may cause electric shocks and body burns. Please wear personal protective equipment (PPE) and start maintaining the inverter at least five minutes after power off.

## 12.2 Troubleshooting

This section lists the possible problems with the inverter, and provides information and procedures for identifying and resolving them. In case of any errors, check for the warnings or error messages on the system control panel or App, and then refer to the suggestions below. For further assistance, contact SolaX Customer Service. Please provide the model and SN of the inverter, and be prepared to describe the system installation details.

Table 12-1 Troubleshooting list

Error Code	Fault	Diagnosis and Solutions
1	Isolation Fault	Insulation impedance detection failed. <ul style="list-style-type: none"><li>• Check whether the wire insulation is intact.</li></ul>
2	Meter Fault	Electricity meter has no power. <ul style="list-style-type: none"><li>• Check the status of the meter.</li></ul>
4	Grid Freq Mismatch	Frequency configuration mismatch. <ul style="list-style-type: none"><li>• Check whether the frequency is within the correct range.</li></ul>
6	Arc Fault	Arc fault <ul style="list-style-type: none"><li>• Wait for a while to see if it returns to normal.</li></ul>

Error Code	Fault	Diagnosis and Solutions
7		1.05 times overload <ul style="list-style-type: none"> <li>• Turn off high-power load.</li> </ul>
8	EPS Overload Fault	1.25 times overload <ul style="list-style-type: none"> <li>• Turn off high-power load.</li> </ul>
9		1.5 times overload <ul style="list-style-type: none"> <li>• Turn off high-power load.</li> </ul>
10	Overload Self-Lock	Overload self-locking <ul style="list-style-type: none"> <li>• Turn off high-power load, PV, battery and power grid, and restart inverter.</li> </ul>
15	Aux Power Volt Fault	Auxiliary power supply abnormal <ul style="list-style-type: none"> <li>• Contact the after-sales personnel.</li> </ul>
17		EPS load current exceeds level 1 overcurrent value <ul style="list-style-type: none"> <li>• Turn off high-power load.</li> </ul>
18	EPS Overload Fault	EPS load current exceeds level 2 overcurrent value <ul style="list-style-type: none"> <li>• Turn off high-power load.</li> </ul>
19		EPS load current exceeds level 3 overcurrent value <ul style="list-style-type: none"> <li>• Turn off high-power load.</li> </ul>
20	PV1 Reversed	PV1 reverse connection <ul style="list-style-type: none"> <li>• Turn off PV, battery and power grid, restart inverter, and check the connection status of positive and negative poles of PV1.</li> </ul>
21	PV2 Reversed	PV2 reverse connection <ul style="list-style-type: none"> <li>• Turn off PV, battery and power grid, restart inverter, and check the connection status of positive and negative poles of PV2.</li> </ul>
22	PV3 Reversed	PV3 reverse connection <ul style="list-style-type: none"> <li>• Turn off PV, battery and power grid, restart inverter, and check the connection status of positive and negative poles of PV3.</li> </ul>
23	MPPT1 Over Voltage	PV1 Voltage is too high <ul style="list-style-type: none"> <li>• Check the voltage of PV1.</li> </ul>
24	MPPT2 Over Voltage	PV2 Voltage is too high <ul style="list-style-type: none"> <li>• Check the voltage of PV2</li> </ul>
25	MPPT3 Over Voltage	PV3 Voltage is too high <ul style="list-style-type: none"> <li>• Check the voltage of PV3</li> </ul>
26	EPS Overload Fault	EPS load current exceeds level 4 overcurrent value <ul style="list-style-type: none"> <li>• Turn off high-power load.</li> </ul>

Error Code	Fault	Diagnosis and Solutions
40	Bat Type Error	Battery type configuration error <ul style="list-style-type: none"> <li>• Turn off PV, battery and power grid, restart inverter, and confirm whether the battery type is correct.</li> </ul>
41	Bat Voltage Fault	Battery voltage is too high <ul style="list-style-type: none"> <li>• Check whether the battery output voltage is within the normal range.</li> </ul>
44	Low Bat SOC	Low battery SOC <ul style="list-style-type: none"> <li>• Please charge the battery in time.</li> </ul>
45	EPS Overload Fault	EPS load power exceeds the battery power <ul style="list-style-type: none"> <li>• Turn off high-power load.</li> </ul>
51	Grid Voltage Fault	The grid voltage exceeds the allowable value 1 <ul style="list-style-type: none"> <li>• Check whether the grid voltage is within the normal working range.</li> </ul>
52		The grid voltage exceeds the allowable value 2 <ul style="list-style-type: none"> <li>• Check whether the grid voltage is within the normal working range.</li> </ul>
53		The grid voltage is lower than the allowable value 1 <ul style="list-style-type: none"> <li>• Check whether the grid voltage is within the normal working range.</li> </ul>
54		The grid voltage is lower than the allowable value 2 <ul style="list-style-type: none"> <li>• Check whether the grid voltage is within the normal working range.</li> </ul>
55		Ac10mins Volt Fault
57	Grid Frequency Fault	Power grid frequency exceeds the allowable value 1. <ul style="list-style-type: none"> <li>• Check whether the grid frequency is within the normal working range.</li> </ul>
58		Power grid frequency exceeds the allowable value 2 <ul style="list-style-type: none"> <li>• Check whether the grid frequency is within the normal working range.</li> </ul>
59		The power grid frequency is lower than the allowable value 1. <ul style="list-style-type: none"> <li>• Check whether the grid frequency is within the normal working range.</li> </ul>
60		The power grid frequency is lower than the allowable value 2. <ul style="list-style-type: none"> <li>• Check whether the grid frequency is within the normal working range.</li> </ul>

Error Code	Fault	Diagnosis and Solutions
61	Grid Voltage Fault	The grid voltage exceeds the allowable value 3 <ul style="list-style-type: none"> <li>• Check whether the grid voltage is within the normal working range.</li> </ul>
62		The grid voltage is lower than the allowable value 3. <ul style="list-style-type: none"> <li>• Check whether the grid voltage is within the normal working range.</li> </ul>
63	Grid Frequency Fault	Power grid frequency exceeds the allowable value 3 <ul style="list-style-type: none"> <li>• Check whether the grid frequency is within the normal working range.</li> </ul>
64		The power grid frequency is lower than the allowable value 3. <ul style="list-style-type: none"> <li>• Check whether the grid frequency is within the normal working range.</li> </ul>
70	BST1 Software OCP	BST1 software overcurrent <ul style="list-style-type: none"> <li>• Please contact the after-sales personnel.</li> </ul>
71	BST2 Software OCP	BST2 software overcurrent <ul style="list-style-type: none"> <li>• Please contact the after-sales personnel.</li> </ul>
72	BST3 Software OCP	BST3 software overcurrent <ul style="list-style-type: none"> <li>• Please contact the after-sales personnel.</li> </ul>
73	Tz Protect Fault	BST1 hardware overcurrent <ul style="list-style-type: none"> <li>• Please contact the after-sales personnel.</li> </ul>
74		BST2 hardware overcurrent <ul style="list-style-type: none"> <li>• Please contact the after-sales personnel.</li> </ul>
75		BST3 hardware overcurrent <ul style="list-style-type: none"> <li>• Please contact the after-sales personnel.</li> </ul>
77	Tz Protect Fault	BuckBst hardware overcurrent <ul style="list-style-type: none"> <li>• Wait for a while to see if it returns to normal.</li> </ul>
78	BuckBst Software OCP	BuckBst software overcurrent <ul style="list-style-type: none"> <li>• Please contact the after-sales personnel.</li> </ul>
79	BuckBst Software OVP	BuckBst software overvoltage <ul style="list-style-type: none"> <li>• Please contact the after-sales personnel.</li> </ul>
80	BuckBst Software UVP	BuckBst software undervoltage <ul style="list-style-type: none"> <li>• Please contact the after-sales personnel.</li> </ul>
81	Tz Protect Fault	Llc hardware overcurrent <ul style="list-style-type: none"> <li>• The battery may be short-circuited. Use a multimeter to check whether the battery port is short-circuited.</li> <li>• Wait for a while to see if it returns to normal.</li> </ul>

Error Code	Fault	Diagnosis and Solutions
82	LLC Start Fail	Llc startup failed. <ul style="list-style-type: none"> <li>• Please contact the after-sales personnel.</li> </ul>
83	BuckBst Start Fail	BuckBst startup failed. <ul style="list-style-type: none"> <li>• Please contact the after-sales personnel.</li> </ul>
85	DC Bus Init Fail	DCBUS initialization detection failed. <ul style="list-style-type: none"> <li>• Turn off PV, battery and power grid, and restart inverter.</li> </ul>
86	Tz Protect Fault	DCBUS hardware overvoltage <ul style="list-style-type: none"> <li>• Please contact the after-sales personnel.</li> </ul>
87	DC Bus Overvoltage	DCBUS software overvoltage <ul style="list-style-type: none"> <li>• Please contact the after-sales personnel.</li> </ul>
88	DC Bus Undervoltage	DCBUS software undervoltage <ul style="list-style-type: none"> <li>• Please contact the after-sales personnel.</li> </ul>
92	BuckBst Soft Start Fail	DCBUS BUCKBST soft start failed. <ul style="list-style-type: none"> <li>• Please contact the after-sales personnel.</li> </ul>
101	INV Relay Fault	Inverter relay fault <ul style="list-style-type: none"> <li>• Please contact the after-sales personnel.</li> </ul>
104	EPS Overload Fault	Soft start AC voltage failed. <ul style="list-style-type: none"> <li>• Please contact the after-sales personnel.</li> </ul>
105	INV Software OCP	Inverter software overcurrent <ul style="list-style-type: none"> <li>• Please contact the after-sales personnel.</li> </ul>
106	EPS Overload Fault	Inverter hardware half-wave overcurrent <ul style="list-style-type: none"> <li>• Please contact the after-sales personnel.</li> </ul>
107	EPS Overload Fault	Inverter hardware overcurrent <ul style="list-style-type: none"> <li>• Please contact the after-sales personnel.</li> </ul>
108	DCI OCP Fault	During on-grid operation, DC component of the inverter exceeds the permissible value. <ul style="list-style-type: none"> <li>• Contact SolaX for help.</li> </ul>
109	DCV OVP Fault	During off-grid operation, DC component of the inverter exceeds the permissible value. <ul style="list-style-type: none"> <li>• Contact SolaX for help.</li> </ul>
110	EPS Overload Fault	EPS overload caused inverter soft-start AC voltage failure. <ul style="list-style-type: none"> <li>• Turn off high-power load.</li> </ul>
111	CT/Meter Check Fault	CT fault <ul style="list-style-type: none"> <li>• Wait for a while to see if it returns to normal. Check whether CT works properly.</li> </ul>
112	GFCI Fault	GFCI fault <ul style="list-style-type: none"> <li>• Wait for a while to see if it returns to normal.</li> </ul>



Error Code	Fault	Diagnosis and Solutions
113	INV Frequent OCP	Inverter frequent overcurrent alarm <ul style="list-style-type: none"> <li>• Wait for a while to see if it returns to normal. Check whether the inverter current works in the normal range.</li> </ul>
114	INV DM OCP	Inverter overcurrent fault <ul style="list-style-type: none"> <li>• Wait for a while to see if it returns to normal.</li> </ul>
116	Gen Voltage PLL Fail	The inverter failed to phase lock the generator <ul style="list-style-type: none"> <li>• Wait for a while to see if it returns to normal.</li> </ul>
117	Gen Overload	1.5 times overload of the generator <ul style="list-style-type: none"> <li>• Turn off high-power load.</li> </ul>
130	INV Overheat	Inverter over temperature fault <ul style="list-style-type: none"> <li>• Check whether the fan works normally. If not, shutdown for inspection. If yes, wait for a while and restart when it is back to normal.</li> </ul>
131	PV Overheat	PV over temperature fault <ul style="list-style-type: none"> <li>• Check whether the fan works normally.</li> </ul>
132	LLC Overheat	LLC over temperature fault <ul style="list-style-type: none"> <li>• Check whether the fan works normally.</li> </ul>
133	High Ambient Temp	Over temperature fault <ul style="list-style-type: none"> <li>• Check whether the fan works normally.</li> </ul>
134	Bat Plate Hot (+)	Battery positive copper plate over temperature fault <ul style="list-style-type: none"> <li>• Check whether the battery power cables can stand the maximum battery current.</li> <li>• Check whether the battery cables are connected correctly and whether the screws are tightened.</li> </ul>
135	Bat Plate Hot (-)	Battery negative copper plate over temperature fault <ul style="list-style-type: none"> <li>• Check whether the battery power cables can stand the maximum battery current.</li> <li>• Check whether the battery cables are connected correctly and whether the screws are tightened.</li> </ul>
140	Type Model Error	Model configuration error <ul style="list-style-type: none"> <li>• Turn off PV, battery and power grid, and restart inverter. Check whether the inverter model is configured correctly.</li> </ul>
145	Para Slave Fault	Slave inverter fault in parallel connection mode <ul style="list-style-type: none"> <li>• Check the error information on the slave inverter and handle the error correspondingly</li> </ul>
146	Para CAN Fault	CAN communication lost in parallel connection mode <ul style="list-style-type: none"> <li>• Check whether the CAN communication cables between the master and the slaves are correctly connected.</li> <li>• Replace the communication cables.</li> </ul>

Error Code	Fault	Diagnosis and Solutions
147	Para Sync Fault	<p>The master and slave inverters failed to synchronize when starting and during operation</p> <ul style="list-style-type: none"> <li>• Check whether the PV, Grid, and battery connections of the master and slave inverters are consistent. If not, reconnect and make sure they are consistent. If yes, wait for fault recovery and automatic restart.</li> </ul>
150	Cell Overvoltage	<p>Overvoltage fault of cell.</p> <ul style="list-style-type: none"> <li>• Wait for fault recovery, restart the battery and contact after-sales personnel.</li> </ul>
151	Cell Undervoltage	<p>Undervoltage fault of cell.</p> <ul style="list-style-type: none"> <li>• Recharge the battery.</li> </ul>
152	Hight Cell Vol Diff	<p>Excessive voltage difference fault of cell.</p> <ul style="list-style-type: none"> <li>• Ensure that the battery works in the normal voltage range.</li> </ul>
153	HVB Overvoltage	<p>Overvoltage fault of total voltage.</p> <ul style="list-style-type: none"> <li>• Wait for fault recovery, restart the battery and contact after-sales personnel.</li> </ul>
154	HVB Undervoltage	<p>Undervoltage fault of total voltage.</p> <ul style="list-style-type: none"> <li>• Recharge the battery.</li> </ul>
155	Overtemp Fault	<p>High temperature fault.</p> <ul style="list-style-type: none"> <li>• Stop using the battery and wait for the temperature to recover.</li> </ul>
156	Self-check Fault	<p>Self-test fault.</p> <ul style="list-style-type: none"> <li>• Check the battery failure and contact the after-sales personnel.</li> </ul>
157	Main Relay Stuck(+)	<p>Main positive relay sticking fault.</p> <ul style="list-style-type: none"> <li>• Please contact the after-sales personnel.</li> </ul>
158	Main Relay Open(+)	<p>Main positive relay open circuit fault.</p> <ul style="list-style-type: none"> <li>• Please contact the after-sales personnel.</li> </ul>
159	Main Relay Stuck(-)	<p>Main negative relay sticking fault.</p> <ul style="list-style-type: none"> <li>• Please contact the after-sales personnel.</li> </ul>
160	Main Relay Open(-)	<p>Main negative relay open circuit fault.</p> <ul style="list-style-type: none"> <li>• Please contact the after-sales personnel.</li> </ul>
161	Precharge Fail	<p>Pre-charge failure fault.</p> <ul style="list-style-type: none"> <li>• Reset the battery. If this fault is reported many times, please contact after-sales personnel.</li> </ul>
162	Cell Sample Fault	<p>Cell sampling fault.</p> <ul style="list-style-type: none"> <li>• Please contact the after-sales personnel.</li> </ul>

Error Code	Fault	Diagnosis and Solutions
163	Temp Sample Fault	Temperature sampling fault. <ul style="list-style-type: none"> <li>• Please contact the after-sales personnel.</li> </ul>
164	System Fault	System fault. <ul style="list-style-type: none"> <li>• Please contact the after-sales personnel.</li> </ul>
165	Dischrg Overcurrent	Over-discharge current fault. <ul style="list-style-type: none"> <li>• Stop using the battery and wait for it to recover or restart the battery. If this fault is reported many times, please contact the after-sales personnel..</li> </ul>
166	Chrg Overcurrent	Over-charge current fault. <ul style="list-style-type: none"> <li>• Ensure that the battery works in the normal voltage range.</li> </ul>
167	AFE Comm Fault	AFE communication fault. <ul style="list-style-type: none"> <li>• Please contact the after-sales personnel.</li> </ul>
168	INV Comm Fault	External network communication fault. <ul style="list-style-type: none"> <li>• Check the communication line between the battery and the inverter. If this fault still occurs after reinserting the line, please contact the after-sales personnel.</li> </ul>
169	Mid Comm Fault	Intermediate network communication fault. <ul style="list-style-type: none"> <li>• Check the communication line between the batteries. If this fault still occurs after reinserting the line, please contact the after-sales personnel.</li> </ul>
170	Voltage Sensor Fault	Voltage sensor fault. <ul style="list-style-type: none"> <li>• Please contact the after-sales personnel.</li> </ul>
171	ID Duplicate	ID duplication fault. <ul style="list-style-type: none"> <li>• Check if the system connections are correct and follow the initial installation steps to perform the startup operation again.</li> </ul>
172	Low Temp Fault	Low temperature fault. <ul style="list-style-type: none"> <li>• Wait for fault recovery, restart the battery and contact after-sales personnel.</li> </ul>
173	Current Sensor Fault	Current sensor fault. <ul style="list-style-type: none"> <li>• Please contact the after-sales personnel.</li> </ul>
174	Power Line Open	Power line open circuit fault. <ul style="list-style-type: none"> <li>• Check whether the power line is connected properly and restart the battery.</li> </ul>
175	Flash Error	Flash fault. <ul style="list-style-type: none"> <li>• Please contact the after-sales personnel.</li> </ul>
176	AFE Protect Fault	AFE self-protection fault. <ul style="list-style-type: none"> <li>• Please contact the after-sales personnel.</li> </ul>

Error Code	Fault	Diagnosis and Solutions
177	Charge Request Fault	Charging request fault. <ul style="list-style-type: none"> <li>• Check if the inverter is correctly supplying power to the battery.</li> </ul>
178	Insulation Fault	Insulation fault. <ul style="list-style-type: none"> <li>• Please contact the after-sales personnel.</li> </ul>
200	Bat Volt Out Limit	Battery voltage overrun <ul style="list-style-type: none"> <li>• Ensure that the battery works in the normal voltage range.</li> </ul>
201	PV Volt Out Limit	Battery voltage overrun <ul style="list-style-type: none"> <li>• Ensure that PV works in the normal voltage range.</li> </ul>
202	Low Grid Bat SOC	Low soc of grid-connected battery <ul style="list-style-type: none"> <li>• Stop discharging and start charging.</li> </ul>
203	Low EPS Bat SOC	Low soc of off-grid battery <ul style="list-style-type: none"> <li>• Stop discharging and start charging.</li> </ul>
204	INV Power De-rate	Inverter power derating <ul style="list-style-type: none"> <li>• Ensure that the inverter power is within the normal range.</li> </ul>
205	Bat Chrg De-rate	Battery charging power derating <ul style="list-style-type: none"> <li>• Ensure that the battery charging power is within the normal range.</li> </ul>
206	Bat Dischrg De-rate	Battery discharge power derating <ul style="list-style-type: none"> <li>• Ensure that the battery discharge power is within the normal range.</li> </ul>
207	Bat Float Charge	Battery floating charge <ul style="list-style-type: none"> <li>• Check battery voltage.</li> </ul>
208	Bat Recharge	Battery recharge <ul style="list-style-type: none"> <li>• Check the battery voltage and replenish the power in time.</li> </ul>
209	Bat Power Config	Battery power configuration mode <ul style="list-style-type: none"> <li>• Make sure that the battery works correctly.</li> </ul>
210	Boost CV Mode	BST constant voltage source mode. <ul style="list-style-type: none"> <li>• BST operates in constant voltage source mode.</li> </ul>
211	PV De-rate, Inv Limit	Inverter power limit <ul style="list-style-type: none"> <li>• Ensure that the inverter output power is within the normal range.</li> </ul>
212	PV De-rate, Rev Flow Alarm	Anti-reflux. <ul style="list-style-type: none"> <li>• Ensure that it is in an anti-reflux state.</li> </ul>
213	PV De-rate, Chrg Limit	Charging power limit. <ul style="list-style-type: none"> <li>• Ensure that the charging power is within the normal range.</li> </ul>

Error Code	Fault	Diagnosis and Solutions
214	PV De-rate, Curr Limit	Current limiting <ul style="list-style-type: none"> <li>• Ensure that the current works within the normal range.</li> </ul>
215	Inter Fan Fault	Internal fan failed. <ul style="list-style-type: none"> <li>• Check whether there is any foreign matter inside the fan.</li> </ul>
240	FAN1Fault	External fan1 failure <ul style="list-style-type: none"> <li>• Please check if the external fan is damaged or blocked.</li> </ul>
241	FAN2Fault	External fan2 failure <ul style="list-style-type: none"> <li>• Please check if the external fan is damaged or blocked.</li> </ul>
242	FAN3Fault	External fan3 failure <ul style="list-style-type: none"> <li>• Please check if the external fan is damaged or blocked.</li> </ul>
243	DSP Upgrade Failed	DSP upgrade failure <ul style="list-style-type: none"> <li>• Please contact after-sales for assistance with software upgrade.</li> </ul>
244	ARM Upgrade Failed	ARM upgrade failure <ul style="list-style-type: none"> <li>• Please contact after-sales for assistance with software upgrade.</li> </ul>
245	SMCU Upgrade Failed	SMCU upgrade failure <ul style="list-style-type: none"> <li>• Please contact after-sales for assistance with software upgrade.</li> </ul>
246	Meter1 Lost	Meter loss <ul style="list-style-type: none"> <li>• Please check if the meter is connected or if the meter communication line works normally.</li> </ul>
247	CT1 Lost	CT loss <ul style="list-style-type: none"> <li>• Please check if the CT is connected.</li> </ul>
249	BMS Lost	Communication loss between inverter and battery management system equipment. <ul style="list-style-type: none"> <li>• Please check the connection status between the BMS device and the inverter.</li> </ul>
250	Meter2 Lost	Meter loss <ul style="list-style-type: none"> <li>• Please check if the meter is connected or if the meter communication line works normally.</li> </ul>
251	CT2 Lost	CT loss <ul style="list-style-type: none"> <li>• Please check if the CT is connected.</li> </ul>

Error Code	Fault	Diagnosis and Solutions
/	Screen not on	<ul style="list-style-type: none"> <li>• Check if the inverter correctly and normally connected to PV, battery or grid.</li> <li>• Contact SolaX for help if the inverter is connected correctly.</li> </ul>
/	Abnormal sound on fan	<ul style="list-style-type: none"> <li>• Check if there is foreign objects stuck in the fan.</li> <li>• Contact SolaX for help.</li> </ul>
/	Screen on but no content display	<ul style="list-style-type: none"> <li>• Contact SolaX for help.</li> </ul>
/	No readings after CT connection	<ul style="list-style-type: none"> <li>• Check if CT is correctly clipped on the L wire</li> <li>• Check if the arrow on the CT points at Grid.</li> <li>• Contact SolaX for help if it can not return to normal.</li> </ul>
/	No readings on Load (on App or Web)	<ul style="list-style-type: none"> <li>• Check if the load is connected correctly.</li> <li>• Check if the power of load on the LCD screen displays normally.</li> <li>• Check if the monitoring module works normally.</li> <li>• Contact SolaX for help if it can not return to normal.</li> </ul>
/	No readings on Grid (on App or Web)	<ul style="list-style-type: none"> <li>• Check if the grid connection is normal.</li> <li>• Check if the grid parameter on the LCD screen displays normally.</li> <li>• Check if the monitoring module works normally.</li> <li>• Contact SolaX for help if it can not return to normal.</li> </ul>
/	No readings on battery (on App or Web)	<ul style="list-style-type: none"> <li>• Check if the battery is connected correctly.</li> <li>• Check if the battery parameter on the LCD screen displays normally.</li> <li>• Check if the monitoring module works normally.</li> <li>• Contact SolaX for help if it can not return to normal.</li> </ul>
/	No Feedin data (on App or Web)w	<ul style="list-style-type: none"> <li>• Check if the meter/CT is connected correctly.</li> <li>• Check if the meter/CT parameter on the LCD screen displays normally.</li> <li>• Check if the monitoring module works normally.</li> <li>• Contact SolaX for help if it can not return to normal.</li> </ul>
/	No data on App or Web	<ul style="list-style-type: none"> <li>• Check if the monitoring module works normally.</li> <li>• Contact SolaX for help.</li> </ul>

---

Error Code	Fault	Diagnosis and Solutions
/	No display on meter after power on	<ul style="list-style-type: none"> <li>• If the meter connection is abnormal, reconnect them according to the wiring diagrams.</li> <li>• Wait for the grid voltage to restore.</li> <li>• Contact SolaX for help if it can not return to normal.</li> </ul>
/	Abnormal electrical data on meter	<ul style="list-style-type: none"> <li>• If the wiring is incorrect, reconnect them based on the wiring diagrams.</li> <li>• Set the voltage and current ratio according to the setting steps of meter user manual.</li> <li>• Contact SolaX for help if it can not return to normal.</li> </ul>

## 12.3 Maintenance

Regular maintenance is required for the inverter. Please check and maintain the following items based on the instructions below to ensure the optimal performance of the inverter. For inverters working in inferior conditions, more frequent maintenance is required. Please keep maintenance records.



**WARNING!**

- Only qualified person can perform the maintenance for the inverter.
- Only spare parts and accessories authorized by SolaX can be used for maintenance.

### 12.3.1 Maintenance routines

Table 12-2 Proposal of Maintenance

Item	Check notes	Maintenance interval
Fans	<ul style="list-style-type: none"> <li>• Check if the fan makes noise or is covered by dust.</li> <li>• Clean the fan with a soft and dry cloth or brush, or replace the fan if necessary.</li> </ul>	Every 12 months
Electrical connection	<ul style="list-style-type: none"> <li>• Ensure that all cables are firmly connected.</li> <li>• Check the integrity of the cables, ensuring that there are no scratches on the parts touching the metallic surface.</li> <li>• Verify that the sealing caps on idle terminals are not falling off.</li> </ul>	Every 12 months

Item	Check notes	Maintenance interval
Grounding reliability	<ul style="list-style-type: none"><li>• Check if the grounding cables are firmly connected to the grounding terminals. Use a ground resistance tester to test the grounding resistance from the inverter enclosure to the PE bar in the power distribution box.</li></ul>	Every 12 months
Heat sink	<ul style="list-style-type: none"><li>• Check if there are foreign objects in the heat sink.</li></ul>	Every 12 months
Dongle	<ul style="list-style-type: none"><li>• Check whether the dongle is securely connected.</li></ul>	From time to time
Indicators	<ul style="list-style-type: none"><li>• Check if the indicators of the inverter are in normal state.</li><li>• Check if the display of the inverter is normal.</li></ul>	From time to time
General status of inverter	<ul style="list-style-type: none"><li>• Check if there is any damage on the inverter.</li><li>• Check if there is any abnormal sound when the inverter is running.</li></ul>	Every 6 months

### 12.3.2 Upgrading Firmware



**WARNING!**

- Make sure that the type and format of the firmware file are correct. Do not modify the file name. Otherwise, the inverter may not work properly.
- Do not modify the folder name and file path where the firmware files are located, as this may cause the upgrade to fail.



**WARNING!**

- Before upgrading, ensure that the PV input voltage is higher than 180 V (preferably on sunny day), or that the battery SOC is higher than 20%, or the battery input voltage is higher than 180 V. Failure to meet one of these conditions may result in upgrade process failure.

#### Upgrade preparation

- Prepare a USB drive (USB 2.0/3.0, ≤32 GB, FAT 16/32).
- Check for the current firmware version of the inverter.
- Contact our service support for the update firmware files, and save them to the root directory of the USB drive.



- » X1LiteLV\_8\_12kW\_Vxxx.xx.bin
- » X1LiteLV\_8\_12kW\_lap.txt

### Upgrade steps

- a. Plug the U disk into the upgrading port below: If the Dongle is connected to the port, please remove the dongle first.
- b. After the U disk is plugged in, the system will start upgrading, and the three indicator lights and the breathing light will flash in turns. (Operating indicator: green; battery indicator: blue; Error indicator: Red). Wait approximately 4-5 minutes.
- c. After successfully upgraded, the breathing light turns green and the buzzer sounds for one second, and the three indicator lights on the LCD will be a constant state. If the breathing light turns red, it means that the upgrade has failed. If the upgrade fails, please contact our after-sales support.

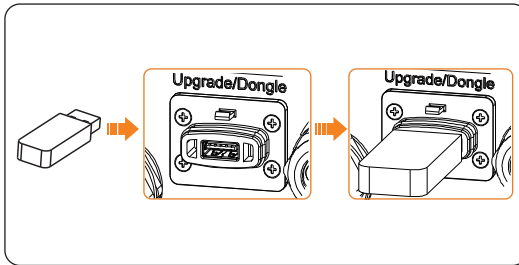

Figure 12-1 Plug in the U disk

#### NOTICE!

- The USB disk can be plugged in when the inverter is in normal status.

# 13 Decommissioning

## 13.1 Disassembling the Inverter



- Strictly follow the steps below to disassemble the inverter.
- Only use the dedicated removal tool to disassemble the AC connector, PV connector, battery connector and communication connector.

- Step 1:** Turn off the system by **ON/OFF** on LCD screen.
- Step 2:** Disconnect the external breakers of the inverter.
- Step 3:** Turn off the system button and the DC switch at the left side of the inverter.
- Step 4:** Turn off the battery switch / button / breaker (if any). (See documents of battery)
- Step 5:** Disconnect the PV connector: Insert the disassemble tool for PV terminal into the notch of PV connector and slightly pull out the connector.

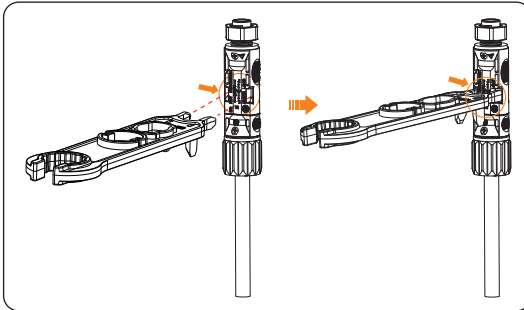

Figure 13-1 Disassembling the PV connector

**Step 6:** Slightly pull out the dongle module.

**Step 7:** Disconnect the battery connectors: remove the M8 screws and loosen the swivel nuts, and slightly pull the connectors. (Torque:  $15\pm 1$  N·m)

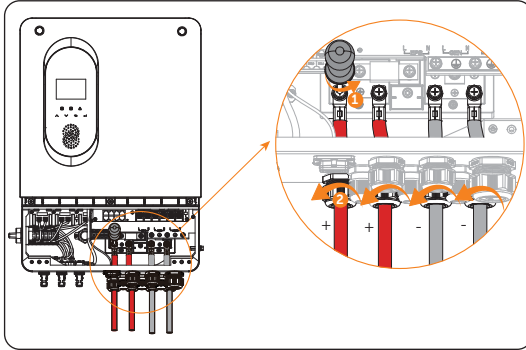

Figure 13-2 Removing the battery connector

**Step 8:** Disconnect EPS, GEN and GRID connector: remove the M6 screws and loosen the swivel nuts, and slightly pull the connectors.

**Step 9:** Disconnect the COM connector: loosen the swivel nut of the COM connector and remove the RJ45 terminals of Meter/CT\_1, Meter/CT\_2, D1/COM, DO, BMS, DRM, PAR\_1 and PAR\_2.

**Step 10:** Put the original terminal caps on the terminals.

**Step 11:** Unscrew the grounding screw and remove the grounding cable.

**Step 12:** Unscrew the M4 screw on the sides of inverter and vertically lift up the inverter to dismantle the inverter. (Torque:  $1.5\pm 0.1$  N·m)

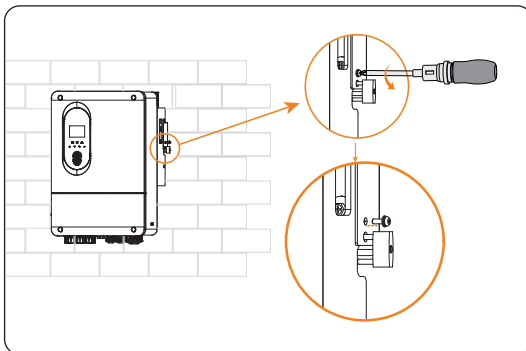

Figure 13-3 Unscrewing the M4 screws

**Step 13:** Unscrew the screws for fastening the wall mounting bracket and remove the wall mounting bracket if needed.

## 13.2 Packing the Inverter

- Use the original packaging materials if available.

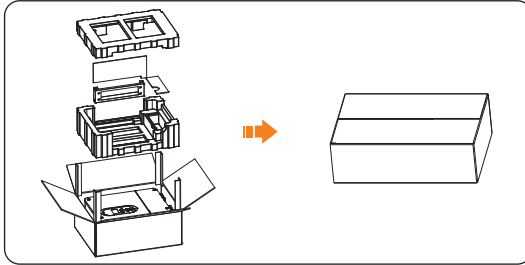

Figure 13-4 Packing the inverter

- If the original packing material is not available, use the packing material which meets the following requirements:
  - » Suitable for the weight and dimension of product
  - » Convenient for transportation
  - » Can be sealed with adhesive tape

## 13.3 Disposing of the Inverter

Properly dispose of the inverter and accessories in accordance with local regulations on the disposal of electronic waste.

# 14 Technical Data

## DC input

Model	X1-Lite-8K-LV	X1-Lite-10K-LV	X1-Lite-12K-LV
Max. recommended PV power [W]	16000	20000	24000
Max PV voltage [d.c. V]	600		
Nominal DC operating voltage [d.c. V]	360		
MPPT voltage range [d.c. V]	50-550		
MPPT full power voltage range [d.c. V]	180-500	200-500	180-500
Max. PV current [d.c. A] <sup>1</sup>	32/32	32/32	32/32/32
Isc PV array short circuit [d.c. A]	40/40	40/40	40/40/40
Start output voltage [d.c. V]	110	110	110
Max. inverter backfeed current to the array [d.c. V]	0		
No. of MPPT	2	2	3
Strings per MPPT	2 / 2	2 / 2	2 / 2 / 2
DC disconnection switch	Yes		

\* <sup>1</sup> When 1 MPPT has 2 string input, if both strings are connected to PV, the maximum string current of a single string does not exceed 16A. If only one string of PV is connected, the maximum single string current does not exceed 32A.

## AC output/ input

Model	X1-Lite-8K-LV	X1-Lite-10K-LV	X1-Lite-12K-LV
<b>AC output</b>			
Rated output apparent power [VA]	8000	10000	12000
Max. output apparent power [VA]	8800	11000	13200
Nominal AC voltage [a.c. V]	220/230/240		
Frequency [Hz]	50/60		
Rated output current [a.c. A]	34.8	43.5	52.2
Max. output continuous current [a.c. A]	40	50	60
Maximum output fault current (at 1ms) [a.c. A]	95	135	
Maximum output overcurrent protection [a.c. A]	110	165	
Power factor range	0.8 leading - 0.8 lagging		
Total harmonic distortion (THDi) (rated power)	< 3%		
<b>AC input</b>			
Max. apparent power [VA]	12650	14950	18400
Rated AC power [W]	12650	14950	18400
Nominal AC voltage [a.c. V]	220/230/240		
Frequency [Hz]	50/60		
Max. AC input current [a.c. A]	55	65	80
Power factor range	0.8 leading - 0.8 lagging		

## Technical Data

Model	X1-Lite-8K-LV	X1-Lite-10K-LV	X1-Lite-12K-LV
<b>AC output &amp; input</b>			
Max. GEN input / output current [a.c. A]	55	65	80
AC connection	L / N / PE		

## Battery

Model	X1-Lite-8K-LV	X1-Lite-10K-LV	X1-Lite-12K-LV
Battery type	Lithium / Lead-Acid		
Battery voltage range [d.c. V]	40-60		
Nominal battery voltage [d.c. V]	48		
Max. charging voltage [d.c. V]	<60 (Adjustable)		
Max. continuous charge/ discharge current [d.c. A]	190	220	250
Charging strategy for Lithium battery	Self-adaption to BMS		
Charging strategy for Lead-Acid battery	3 stages curve		
Temperature sensor	Optional		

## Efficiency, Safety and Protection

Model	X1-Lite-8K-LV	X1-Lite-10K-LV	X1-Lite-12K-LV
<b>Efficiency</b>			
MPPT efficiency	>99.9%	>99.9%	>99.9%
European efficiency	97.0%	97.0%	97.0%
Maximum efficiency	97.6%	97.6%	97.6%
Battery charge efficiency <sup>2</sup>	95.0%	95.0%	95.0%
Battery discharge efficiency <sup>2</sup>	94.0%	94.0%	94.0%
<b>Safety and Protection</b>			
Safety	IEC/EN 62109-1/-2		
Grid monitoring	NRS 097-2-1, IEC61727, IEC62116, PEA, MEA, BIS		
DC SPD protection	Integrated		
AC SPD protection	Integrated		
Active anti-islanding method	Frequency Shift		
PV string input reverse polarity protection	Yes		
Insulation resistor detection	Yes		
Residual current monitoring unit	Yes		
Output over current protection	Yes		
Output short protection	Yes		
Output over voltage protection	Yes		
Battery terminal temp protection	Yes		
Surge protection	AC Type II / DC Type II		

\* <sup>2</sup> PV to BAT Max. efficiency 96.0%, BAT to AC Max. efficiency 95.0%.

## EPS (Off-grid) output

Model	X1-Lite-8K-LV	X1-Lite-10K-LV	X1-Lite-12K-LV
Rated EPS apparent power [VA]	8000	10000	12000
Nominal EPS voltage [a.c. V]	230		
Frequency	50/60		
Rated EPS current [a.c. A]	34.8	43.5	52.2
Peak apparent power [VA, s] <sup>3</sup>	16000, 10	20000, 10	24000, 10
Switching time (typical value) [ms]	< 4		
Total harmonic distortion (THDv) (linear load)	< 2%		

\* \*\* Depend on PV and battery capacity.

## Generic data

Model	X1-Lite-8K-LV	X1-Lite-10K-LV	X1-Lite-12K-LV
Dimensions (W/H/D) [mm]	462*651*280		
Dimensions of packing (W/H/D) [mm]	595*790*340		
Net weight [kg]	35.3	36.9	38.5
Gross weight * [kg]	40.6	42.4	44
Cooling concept	Smart cooling		
Noise emission (typical) [dB(A)]	< 45		
Storage temperature range [°C]	-25 to +70		
Operating ambient temperature range [°C]	-25 to +60 (derating above +45)		
Humidity [%]	4 to 100 (condensing)		
Altitude [m]	< 3000		
Ingress protection	IP65		
Pollution degree	II(Inside), III(Outside)		
Self consumption (night) [W]	< 10		
Installation mode	Wall bracket		
Inverter topology	Non-isolated for PV Side / HF for Battery Side		
Human machine interfaces	LED+LCD		
Communication interfaces	CAN, RS485, CT, Meter, USB, NTC, WiFi+Lan (optional)		

\* The specific gross weight is subject to the actual situation of the whole machine, which may be a little different due to the influence of the external environment.

# 15 Appendix

---

## 15.1 Application of Parallel Function

### 15.1.1 Introduction of Parallel Application

The series inverters supports parallel operation in both Grid and EPS modes. It supports up to 10 units in the parallel system. This function will be released in quarter 1 of 2025.

### 15.1.2 Notice for Parallel Application

- All inverters should be of the same software version.
- For optimal efficiency, it is recommended that all inverters have the same model, and are connected to batteries of the same model and quantity.
- In parallel system, there are two status: **Slave** and **Master**.

Table 15-1 Two status

Slave	When one inverter is set as a <b>Master</b> , all other inverters will enter <b>Slave</b> mode after these inverters are set as <b>Slave</b> .
Master	When one inverter is set as a <b>Master</b> , this inverter enters <b>Master</b> mode.

- Master inverter has an absolute lead in the parallel system to control slave inverter's energy management and dispatch control. Any master or slave inverter has some error and stop working, the parallel system will be stop simultaneously.
- Both master and slave modes can be changed and set via the LCD screen while the power is off.
- Overall system will be running according to master inverter's setting parameters, and most setting parameters of slave inverter will be kept but not be cancelled.
- Once slave inverter exits from the system and be running as an independent unit (the network cable is disconnected simultaneously), its all setting will be re-activated.
- The parallel system is extremely complex and requires a large number of cables to be connected. Therefore, the cables must be connected in the correct wire sequence. Otherwise, any small mistake can lead to system failure.



## NOTICE!

- The communication cable length between two parallel inverters should not exceed 2 meters, and the total cable length of all parallel inverters should not exceed 15 meters.
- When multiple inverters are connected in parallel, they can share one battery cluster. For details about the wiring procedures, please refer to the corresponding user manual of the battery.

## 15.1.3 System Wiring Diagram

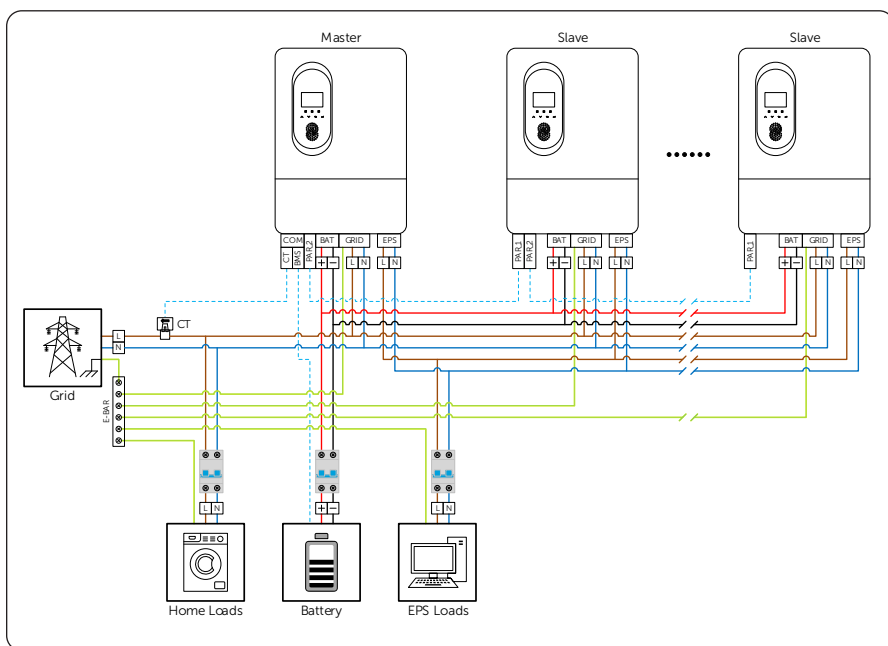

Figure 15-1 System wiring diagram

### 15.1.4 System Wiring Procedure

#### Power cable wiring-Grid and EPS terminal

- a. Grid terminal of Master and Slave inverter: L connects to L and N connects to N,
- b. EPS terminal of Master and Slave inverter: L connects to L and N connects to N,
- c. All PE cable connects to the same E-BAR nearby.

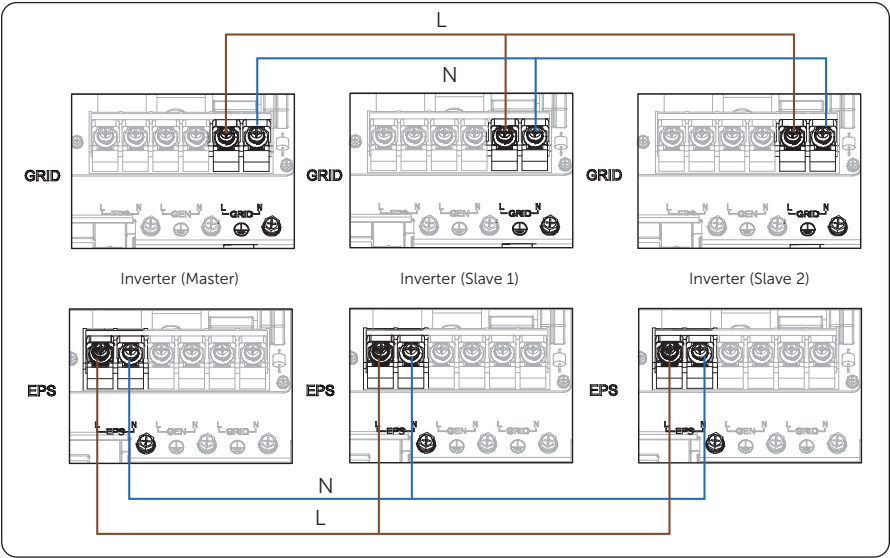

Figure 15-2 Power cable wiring

### Communication cable wiring-COM terminal and COM terminal

- Use standard network cables for Master-Slave inverter connection.
- Master inverter Parallel-2 connects to Slave 1 inverter Parallel-1.
- Slave 1 inverter Parallel-2 connects to Slave 2 inverter Parallel-1.
- Meter/CT connects to Meter/CT-1 or Meter/CT-2 terminal of the Master inverter. The following wiring is taken Meter/CT-1 terminal as an example.

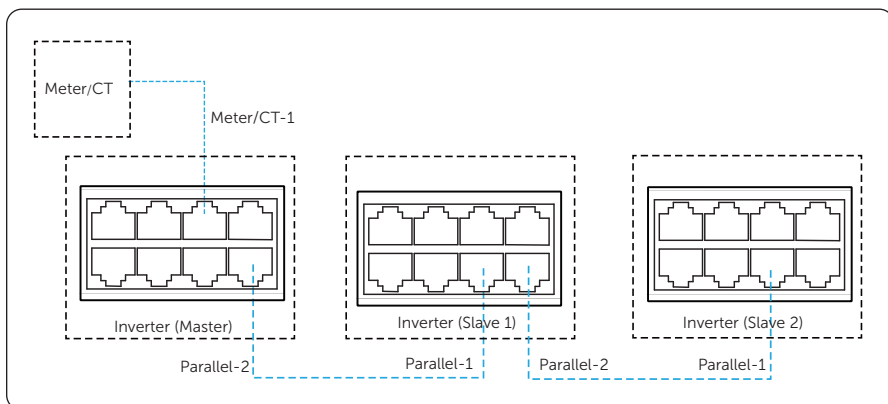

Figure 15-3 Communication wiring

## 15.1.5 Settings for Parallel Connection

### Parallel setting

Setting path:  > **Parallel Setting**

The series inverters support up to 10 units in the parallel system.

- **Master/Slaver Settings:** You can set the state of inverter to **Single** or Parallel. When parallel, the state of inverter can be set to Master/Slave. Select **Master** for the master inverter and **Slave** 1~9 for the slave inverters.
- **Parallel Numbers:** You can set parallel numbers as 1~10 on the master inverter according to the actual application which include both the master and slaves.
- **Terminal resistor:** Inverters with only one parallel communication line need to enable the **Terminal Resistor**. After enabling the **Terminal Resistor** of the two inverters, the whole parallel system can successfully be connected and realize inter-inverter communication.

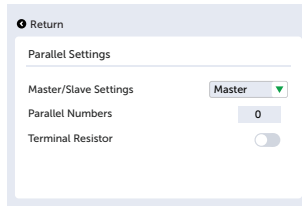
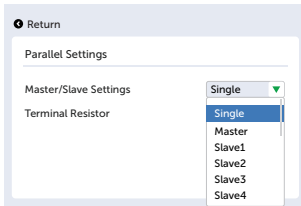

## 15.2 Application of Generator

### 15.2.1 Introduction of Generator Application

When utility power supply is unavailable, the system can seamlessly switch to the generator for power supply and collaborate with the energy storage system to ensure the uninterrupted use of the load.

In this case, the generator functions as the power grid to supply power for the load, and the hybrid inverter converts the solar energy to electricity.

### 15.2.2 Notice for Generator Application

- Note 1: The rated output power of the generator should be greater than the sum of the load power and the battery charging power. If there are several inverters in parallel, the rated output power of the generator should be greater than the sum of the load power and the battery charging power of the inverters.
- Note 2: If the rated output power of the generator is small and cannot meet the requirements of Note 1, the setting value of **Max Power Obtain From Gen** can be changed in the **Menu>Smart Load>Generator>Gen Charge Period** to ensure that the generator power can meet the load and battery charging use at the same time.
- Note 3: The EPS load power cannot be greater than the battery discharge power to prevent the battery power from being unable to meet the EPS load after the generator shuts down and the inverter will report an **EPS Overload Fault** alarm. If two inverters are paralleled, the EPS load power shall be doubled.

### 15.2.3 Dry Contact Mode

In this operating mode, users can intelligently control the system by establishing a dry contact connection between the inverter and the generator. It allows for adjustments to multiple parameters so that the system can meet the requirements of different scenarios.

#### Wiring connection diagram

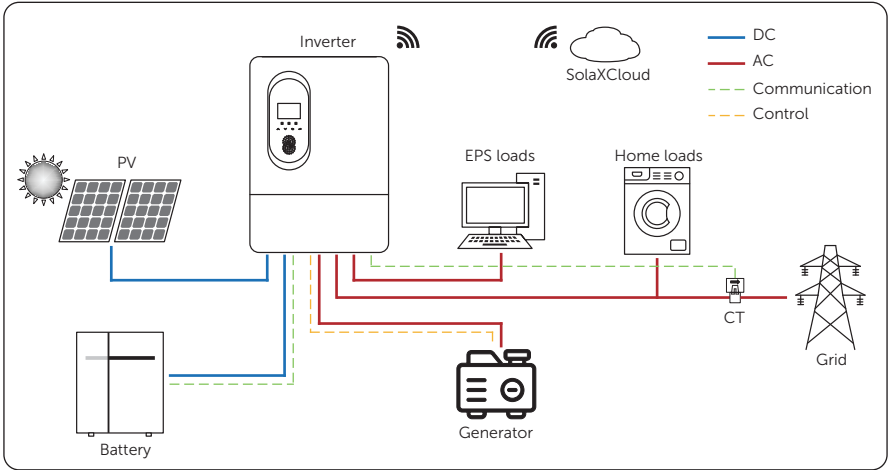

Figure 15-4 Dry contact wiring diagram

#### Inverter connection for dry contact mode

- Power cable: Connection terminal - GEN connection terminal
- Communication cable: Connection terminal - DO of COM communication terminal

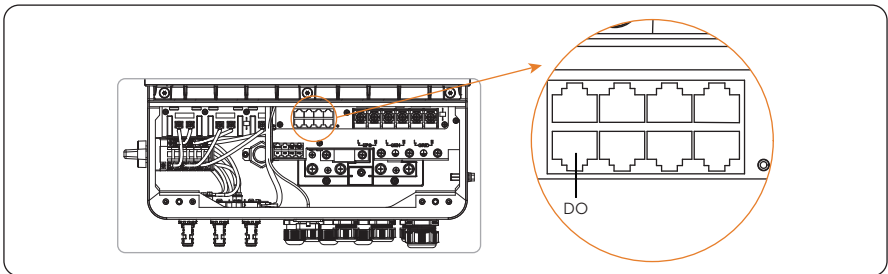

Figure 15-5 Connection terminal for generator

- Connection pins

Table 15-1 Connection pins for generator

Pin	Assignment	Description
6	DO1_1	For generator connection
8	DO1_2	

- Connection steps: Please refer to "8.3 EPS, GEN and GRID Connection" & "8.6 COM Communication Connection" for specific wire making and connection.

### Inverter settings for dry contact mode

Setting path:  > **Smart Load** > **Generator**

- **Gen Rated Power:** Set the rated power of the generator based on the actual situation. Default: 8.0 kW, range: 0.0~20.0 kW
- **Gen Max Run Time:** Maximum operating time of the generator. Default: 1000min, range: 3~60000min
- **Gen Cool Time:** The cooling time interval between two operating sections of the generator. Default: 60min, range: 0~1440min

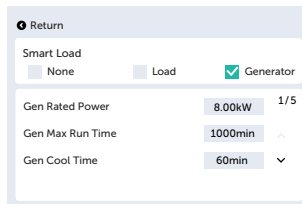

- **Gen Start SOC:** When the battery SOC is less than this set value, the generator will start to charge the battery while supply power for the load. Default: 20%, range: 17%~78%

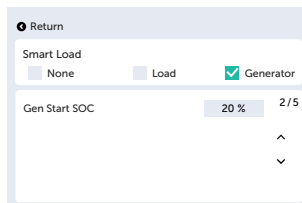

- **Gen Charge Period:** The generator will charge the battery during the set period(s). Totally three periods can be set and at least one period (**Gen Charge Period 1**) should be set. You can decide whether to enable **Gen Charge Period 2** and **Gen Charge Period 3** by touching to select the square on the right side.
  - » **Charge:** Set the **Start** time and **End** time.

- » **Gen Charge Stop SOC:** When the battery SOC is more than this set value, the generator will stop charging the battery. Default: 80%, range: 22%~100%
- » **Max Power Obtain From Gen:** Maximum battery charging power from the generator. You can decide whether to enable this setting by touching to select the square on the right side. Default: 5000 W, range:0~65535 W

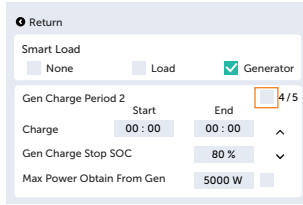
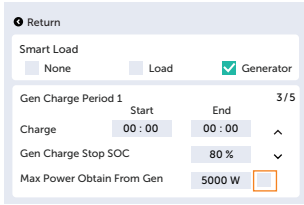



# Contact Information



## UNITED KINGDOM

---

- 📍 Unit C-D Riversdale House, Riversdale Road, Atherstone, CV9 1FA
- ☎ +44 (0) 2476 586 998
- ✉ service.uk@solaxpower.com



## TURKEY

---

- 📍 Fevzi Çakmak mah. aslım cd. no 88 A Karatay / Konya / Türkiye
- ✉ service.tr@solaxpower.com



## USA

---

- 📍 3780 Kilroy Airport Way, Suite 200, Long Beach, CA, US 90806
- ☎ +1 (408) 690 9464
- ✉ info@solaxpower.com



## POLAND

---

- 📍 WARSAW AL. JANA P. II 27. POST
- ☎ +48 662 430 292
- ✉ service.pl@solaxpower.com



## ITALY

---

- ☎ +39 011 19800998
- ✉ support@solaxpower.it



## PAKISTAN

---

- ✉ service.pk@solaxpower.com



## AUSTRALIA

---

- 📍 21 Nicholas Dr, Dandenong South VIC 3175
- ☎ +61 1300 476 529
- ✉ service@solaxpower.com.au



## GERMANY

---

- 📍 Am Tullnaupark 8, 90402 Nürnberg, Germany
- ☎ +49 (0) 6142 4091 664
- ✉ service.eu@solaxpower.com
- ✉ service.dach@solaxpower.com



## NETHERLANDS

---

- 📍 Twekkeler-Es 15 7547 ST Enschede
- ☎ +31 (0) 8527 37932
- ✉ service.eu@solaxpower.com
- ✉ service.bnl@solaxpower.com



## SPAIN

---

- ☎ +34 9373 79607
- ✉ tecnico@solaxpower.com



## BRAZIL

---

- ☎ +55 (34) 9667 0319
- ✉ info@solaxpower.com



## SOUTH AFRICA

---

- ✉ service.za@solaxpower.com



**SolaX Power Network Technology (Zhejiang) Co., Ltd.**

Add.: No. 278, Shizhu Road, Chengnan Sub-district, Tonglu County,  
Hangzhou, Zhejiang, China

E-mail: [info@solaxpower.com](mailto:info@solaxpower.com)

