

# TEST REPORT

Product Name : Adapter Box  
Model Number : Adapter Box G2

Prepared for : SOLAX POWER NETWORK TECHNOLOGY (ZHEJIANG)  
CO., LTD.

Address : No.288, Shizhu Road, Tonglu Economic Development  
Zone, Tonglu City, Zhejiang Province 310000, P. R. China

Prepared by : EMTEK (NINGBO) CO., LTD.  
Address : No. 8, Building 8, Lane 216, Qingyi Road, Ningbo Hi-Tech  
Zone, Ningbo, Zhejiang, China

Tel: +86-574-27907998  
Fax: +86-574-27721538

Report Number : ENB2209290149E00201R  
Date(s) of Tests : September 29, 2022 to December 08, 2022  
Date of issue : December 22, 2022



## TABLE OF CONTENT

Test Report Description	Page
<b>1. DESCRIPTION OF STANDARDS AND RESULTS (EUT)</b> .....	<b>6</b>
<b>2. GENERAL INFORMATION</b> .....	<b>7</b>
2.1. Description of Device (EUT) .....	7
2.2. Input / Output Ports.....	7
2.3. Independent Operation Modes .....	8
2.4. Test Manner .....	8
2.5. Description of Support Device .....	8
2.6. Description of Test Facility .....	9
2.7. Test Software .....	9
2.8. Measurement Uncertainty.....	10
<b>3. MEASURING DEVICE AND TEST EQUIPMENT</b> .....	<b>11</b>
3.1. For Conducted Emission at AC Mains Port Measurement .....	11
3.2. For Conducted Emissions at Telecommunications/network port Measurement.....	11
3.3. For Radiated Emission Measurement (Up to 1 GHz).....	12
3.4. For Radiated Emission Measurement (Above 1 GHz) .....	12
3.5. For Harmonic Current/Flicker Measurement .....	13
3.6. For Electrostatic Discharge Immunity Test .....	13
3.7. For RF Strength Susceptibility Test .....	13
3.8. For Electrical Fast Transient /Burst Immunity Test .....	14
3.9. For Surge Immunity Test.....	14
3.10. For Injected Current Susceptibility Test .....	15
3.11. For Voltage Dips and Interruptions Test.....	15
<b>4. CONDUCTED EMISSIONS FROM THE AC MAINS POWER PORTS</b> .....	<b>16</b>
4.1. Block Diagram of Test Setup .....	16
4.2. Limits.....	16
4.3. Test Procedure.....	16
4.4. Measuring Results .....	17
<b>5. ASYMMETRIC MODE CONDUCTED EMISSIONS AT WIRED NETWORK PORTS</b> .....	<b>22</b>
5.1. Block Diagram of Test Setup .....	22
5.2. Limits.....	22
5.3. Test Procedure.....	22
5.4. Measuring Results .....	23
<b>6. RADIATED EMISSION MEASUREMENT (UP TO 1GHZ)</b> .....	<b>26</b>
6.1. Block Diagram of Test Setup .....	26
6.2. Radiated Limit.....	26
6.3. Test Procedure.....	26
6.4. Measuring Results .....	27
<b>7. RADIATED EMISSION MEASUREMENT (ABOVE 1GHZ)</b> .....	<b>32</b>
7.1. Block Diagram of Test Setup .....	32
7.2. Radiated Limit.....	32
7.3. Test Procedure.....	33
7.4. Measuring Results .....	33
<b>8. HARMONIC CURRENT EMISSION MEASUREMENT</b> .....	<b>38</b>
8.1. Block Diagram of Test Setup .....	38
8.2. Standard Limits .....	38
8.3. Test Procedure.....	39
8.4. Test Results .....	39
<b>9. VOLTAGE FLUCTUATION AND FLICKER MEASUREMENT</b> .....	<b>43</b>
9.1. Block Diagram of Test Setup .....	43

9.2. Standard Limits .....	43
9.3. Test Procedure.....	43
9.4. Test Results .....	43
<b>10. IMMUNITY GENERAL PERFORMANCE CRITERIA DESCRIPTION .....</b>	<b>45</b>
<b>11. ELECTROSTATIC DISCHARGE .....</b>	<b>46</b>
11.1. Test Specification .....	46
11.2. Block Diagram of Test Setup .....	46
11.3. Test Procedure.....	46
11.4. Test Results .....	47
<b>12. CONTINUOUS RF ELECTROMAGNETIC FIELD DISTURBANCES.....</b>	<b>48</b>
12.1. Test Specification .....	48
12.2. Block Diagram of Test Setup .....	48
12.3. Test procedure .....	48
12.4. Test results .....	49
<b>13. ELECTRICAL FAST TRANSIENTS/BURST .....</b>	<b>50</b>
13.1. Test Specification .....	50
13.2. Block Diagram of Test Setup .....	50
13.3. Test Procedure.....	51
13.4. Test Results .....	51
<b>14. SURGES .....</b>	<b>52</b>
14.1. Test Specification .....	52
14.2. Block Diagram of Test Setup .....	52
14.3. Test Procedure.....	52
14.4. Test results .....	53
<b>15. CONTINUOUS INDUCED RF DISTURBANCES .....</b>	<b>54</b>
15.1. Test Specification .....	54
15.2. Block Diagram of Test Setup .....	54
15.3. Test Procedure.....	54
15.4. Test results .....	55
<b>POWER FREQUENCY MAGNETIC FIELD .....</b>	<b>56</b>
15.5. Test Specification .....	56
15.6. Block Diagram of Test Setup .....	56
15.7. Test Procedure.....	56
15.8. Test Results .....	56
<b>16. VOLTAGE DIPS AND INTERRUPTIONS .....</b>	<b>57</b>
16.1. Test Specification .....	57
16.2. Block Diagram of Test Setup .....	57
16.3. Test Procedure.....	57
16.4. Test results .....	58
<b>17. PHOTOGRAPHS .....</b>	<b>59</b>
17.1. Photo of Conducted Emission Measurement .....	59
17.2. Photo of Conducted Emissions at Telecommunications/network port Measurement.....	60
17.3. Photo of Radiation Emission Measurement (Up to 1GHz) .....	61
17.4. Photo of Radiation Emission Measurement ( Above 1GHz).....	62
17.5. Photo of Harmonic and Flicker Measurement .....	62
17.6. Photo of Electrostatic Discharge Test .....	63
17.7. Photo of RF Field Strength Susceptibility Test.....	63
17.8. Photo of Electrical Fast Transient /Burst Test .....	64
17.9. Photo of Surge Test .....	64
17.10. Photo of Injected Currents Susceptibility Test .....	65
17.11. Photo of Voltage Dips and Interruption Immunity Test.....	65

APPENDIX (Photos of the EUT) (7 Pages)

## TEST REPORT DESCRIPTION

Applicant : SOLAX POWER NETWORK TECHNOLOGY (ZHEJIANG) CO., LTD.  
Manufacturer : SOLAX POWER NETWORK TECHNOLOGY (ZHEJIANG) CO., LTD.  
Trade Mark : SolaX Power  
EUT : Adapter Box  
Model Number : Adapter Box G2  
Input Voltage : AC 100-240V, 50/60Hz

**Measurement Procedure Used:**

BS EN 55032:2015+A1:2020  
BS EN IEC 61000-3-2:2019+A1:2021  
BS EN 61000-3-3:2013/A2:2021  
BS EN 55035:2017+A11:2020  
(IEC 61000-4-2:2008, IEC 61000-4-3:2006+A1:2007+A2:2010, IEC 61000-4-4:2012,  
IEC 61000-4-5:2005, IEC 61000-4-6:2008, IEC 61000-4-8:2009, IEC 61000-4-11:2004)

The device described above is tested by EMTEK (NINGBO) CO., LTD. to determine the maximum emission levels emanating from the device and the severe levels of the device can endure and its performance criterion. The measurement results are contained in this test report and EMTEK (NINGBO) CO., LTD. is assumed full of responsibility for the accuracy and completeness of these measurements. Also, this report shows that the EUT (Equipment Under Test) is technically compliant with the BS EN 55032, BS EN IEC 61000-3-2, BS EN 61000-3-3, BS EN 55035 requirements.

This report applies to above tested sample only and shall not be reproduced in part without written approval of EMTEK (NINGBO) CO., LTD.

Date of Test : September 29, 2022 to December 08, 2022

Prepared by :   
June Gao/Engineer

Reviewer :   
Ade Wang/Supervisor

Approved & Authorized Signer :   
Tony Wei/Manager



## Modified Information

Version	Report No.	Revision Date	Summary
	ENB2209290149E00201R	/	Original Report



## 1. DESCRIPTION OF STANDARDS AND RESULTS (EUT)

EMISSION				
Description of Test Item		Standard	Limits	Results
Conducted Emissions From the AC Mains Power Ports		BS EN 55032:2015+A1:2020	Class B	Pass
Asymmetric mode conducted emissions	Wired network ports	BS EN 55032:2015+A1:2020	Class B	Pass
	Optical fibre ports	BS EN 55032:2015+A1:2020	Class B	N/A
	Broadcast receiver tuner ports	BS EN 55032:2015+A1:2020	Class B	N/A
	Antenna ports	BS EN 55032:2015+A1:2020	Class B	N/A
Conducted differential voltage emissions	TV broadcast receiver tuner ports	BS EN 55032:2015+A1:2020	Class B	N/A
	RF modulator output ports	BS EN 55032:2015+A1:2020	Class B	N/A
	FM broadcast receiver tuner ports	BS EN 55032:2015+A1:2020	Class B	N/A
Radiated emissions at frequencies up to 1 GHz		BS EN 55032:2015+A1:2020	Class B	Pass
Radiated emissions at frequencies above 1 GHz		BS EN 55032:2015+A1:2020	Class B	Pass
Radiated emissions from FM receivers		BS EN 55032:2015+A1:2020	Table A.6	N/A
Outdoor units of home satellite receiving systems		BS EN 55032:2015+A1:2020	Table A.7	N/A
Harmonic Current Emissions		BS EN IEC 61000-3-2:2019+A1:2021	Class A	Pass
Voltage Fluctuation and Flicker		BS EN 61000-3-3:2013/A2:2021	Section 5	Pass
IMMUNITY(BS EN 55035:2017+A11:2020)				
Description of Test Item		Basic Standard	Performance Criteria	Results
Electrostatic Discharge	Enclosure ports	IEC 61000-4-2:2008	B	Pass
Continuous RF electromagnetic field disturbances	Enclosure ports	IEC 61000-4-3:2006+A1:2007+A2:2010	A	Pass
Electrical fast transients/burst	AC mains power ports	IEC61000-4-4:2012	B	Pass
	Analogue/digital data ports		B	Pass
	DC network power ports		B	N/A
Surges	AC mains power ports	IEC 61000-4-5:2005	B	Pass
	Analogue/digital data ports for unshielded symmetrical		C	Pass
	Analogue/digital data ports for coaxial or shielded		B	N/A
	DC network power ports		B	N/A
Continuous induced RF disturbances	AC mains power ports	IEC 61000-4-6:2008	A	Pass
	Analogue/digital data ports		A	Pass
	DC network power ports		A	N/A
Power frequency magnetic field	Enclosure ports	IEC 61000-4-8:2009	A	N/A
Voltage dips and interruptions	AC mains power ports	IEC 61000-4-11:2004	B,C	Pass
Broadband impulsive conducted disturbances	Analogue/digital data ports	\	N/A	N/A
Note: N/A is an abbreviation for Not Applicable.				

## 2. GENERAL INFORMATION

### 2.1. Description of Device (EUT)

EUT : Adapter Box

Model Number : Adapter Box G2

Test Voltage : AC 230V/50Hz, AC 120V/60Hz

AC Adapter : M/N: ABT020120A  
 Input: AC 100-240V, 50/60Hz, 1.5A  
 Output: DC 12V, 2A, 24W

Highest Frequency : 2400 MHz

Sample Number : ENB2209290149E002-1-1

Applicant : SOLAX POWER NETWORK TECHNOLOGY (ZHEJIANG) CO., LTD.

Address : No.288, Shizhu Road, Tonglu Economic Development Zone, Tonglu City, Zhejiang Province 310000, P. R. China

Manufacturer : SOLAX POWER NETWORK TECHNOLOGY (ZHEJIANG) CO., LTD.

Address : No.288, Shizhu Road, Tonglu Economic Development Zone, Tonglu City, Zhejiang Province 310000, P. R. China

Date of Received : September 29, 2022

Date of Test : September 29, 2022 to December 08, 2022

### 2.2. Input / Output Ports

Port #	Name	Type*	Cable Max. >3m	Cable Shielded	Comments
1	Enclosure	N/E	--	--	None
2	Net Port	A/D	--	--	None
3	AC Port	AC	--	--	None
4	DC Line	DC	No	Unshielded	None

\*Note: Use abbreviations:

AC= AC Power port

DC= DC Power port

N/E= Non-Electrical

A/D=Analogue/digital data port (signal/control port, antenna port, wired network port, broadcast receiver tuner port, optical fibre port)

### 2.3. Independent Operation Modes

A. ON

### 2.4. Test Manner

Test Items	Test Voltage	Operation Modes	Worst case
Conducted disturbance at mains Terminals	AC 230V/50Hz AC 120V/60Hz	Mode A	Mode A
Asymmetric mode conducted emissions	AC 230V/50Hz AC 120V/60Hz	Mode A	Mode A
Radiated emissions at frequencies up to 1 GHz	AC 230V/50Hz AC 120V/60Hz	Mode A	Mode A
Radiated emissions at frequencies above 1 GHz	AC 230V/50Hz AC 120V/60Hz	Mode A	Mode A
Harmonic Current Emissions	AC 230V/50Hz	Mode A	Mode A
Voltage Fluctuation and Flicker	AC 230V/50Hz	Mode A	Mode A
Electrostatic Discharge	AC 230V/50Hz	Mode A	Mode A
Continuous RF Electromagnetic Field Disturbances	AC 230V/50Hz	Mode A	Mode A
Electrical Fast Transient / Burst	AC 230V/50Hz	Mode A	Mode A
Surges	AC 230V/50Hz	Mode A	Mode A
Continuous induced RF disturbances	AC 230V/50Hz	Mode A	Mode A
Voltage dips and interruptions	AC 230V/50Hz AC 230V/60Hz	Mode A	Mode A

### 2.5. Description of Support Device

Notebook : Manufacturer: LENOVO  
M/N: T430s  
S/N: R9RK4YK



## 2.6. Description of Test Facility

Site Description

EMC Lab. A

: **Accredited by CNAS**

The Certificate Registration Number is L6666.

The Laboratory has been assessed and proved to be in compliance with CNAS-CL01:2018 (identical to ISO/IEC 17025:2017)

**Accredited by FCC**

Designation Number: CN1302

Test Firm Registration Number: 436491

**Accredited by A2LA**

The certificate is valid until May 31, 2023

**Accredited by Industry Canada**

The Conformity Assessment Body Identifier is CN0114

Name of Firm

: EMTEK (NINGBO) CO., LTD.

Site Location

: No. 8, Building 8, Lane 216, Qingyi Road, Ningbo Hi-Tech Zone, Ningbo, Zhejiang, China

## 2.7. Test Software

Item

Software

Conducted Emission

: TS+ (Ver. 4.0.0.0)

Radiated Emission

: TS+ (Ver. 4.0.0.0)

## 2.8. Measurement Uncertainty

Test Item	Uncertainty
Conducted Emission Uncertainty	: 2.08dB (9 k-150 kHz) 2.40dB (150 k-30 MHz)
Radiated Emission Uncertainty (3m Chamber)	: 4.06dB (Polarize: H) (30MHz-1000MHz) 4.04dB (Polarize: V) (30MHz-1000MHz) 4.82dB (Polarize: H) (1~18GHz) 4.80dB (Polarize: V) (1~18GHz)
Uncertainty for Harmonic test	: 4.16% mA
Uncertainty for Flicker test	: 0.43% V
Uncertainty for ESD Test	: 6.00% kV
Uncertainty for EFT/B Test	: 3.84% kV
Uncertainty for Surge Test	: 0.53% kV
Uncertainty for C/S Test	: 1.45dB (Using CDN Test) 2.37dB (Using EM Clamp Test)
Uncertainty for DIPS Test	: 2.12% V
Uncertainty for R/S Test	: 2.10dB(80 MHz-200 MHz) 2.36dB(200 MHz-1000 MHz) 2.57dB(1000 MHz-6000 MHz)

### 3. MEASURING DEVICE AND TEST EQUIPMENT

#### 3.1. For Conducted Emission at AC Mains Port Measurement

Equ. No.	Equipment	Manufacturer	Model No.	Serial No.	Last Cal.	Cal. Interval
ENE-002	EMI Test Receiver	Rohde & Schwarz	ESCI	101107	July 07, 2022	1 Year
ENE-003	L.I.S.N	Rohde & Schwarz	ENV216	101193	July 07, 2022	1 Year
ENE-004	L.I.S.N	Schwarzbeck	NSLK 8126	8126-462	July 07, 2022	1 Year
ENE-006	Pulse Limiter	MTS-systemtechnik	IMP-136	2611115-001-0033	July 07, 2022	1 Year
ENE-005	RF Switching unit	CD	RSU-M2	38400	July 07, 2022	1 Year

#### 3.2. For Conducted Emissions at Telecommunications/network port Measurement

Equ. No.	Equipment	Manufacturer	Model No.	Serial No.	Last Cal.	Cal. Interval
ENE-186	EMI Test Receiver	R&S	ESR7	102487	May 27, 2022	1 Year
ENE-067	I.S.N	Tsetq	ISNT8	51926	Jan. 10, 2022	1 Year
ENE-068	I.S.N	Tsetq	ISNT8-Cat 6	50583	Jan. 10, 2022	1 Year
ENE-159	Pulse Limiter	Schwarzbeck	VTSD 9561F-N	0929	Dec.20, 20021	1 Year
ENE-278	RF Switching unit	HTEC	HRSU	222101	August 22, 2022	1 Year
ENE-083	RF Cable	Hubber Suhner/Swiss	CBL-RE-3	/	April 07, 2022	1 Year

### 3.3. For Radiated Emission Measurement (Up to 1 GHz)

Equ. No.	Equipment	Manufacturer	Model No.	Serial No.	Last Cal.	Cal. Interval
ENE-185	EMI Test Receiver	R&S	ESR7	102480	May 18, 2022	1 Year
ENE-190	Antenna multiple	Schwarzbeck	VULB 9163	01499	May 21, 2022	2 Year
ENE-195	Pre-Amplifier	JS Denki	PA09K03-40	JSPA21019	May 18, 2022	1 Year
ENE-204	Low frequency notch filter Rf switching	JS Denki	JSDSW-F	JSDSW2211 D02	May 27, 2022	1 Year
ENE-279-1	RF cable	Rosenberger	L17-C001-7000	/	June 01, 2022	1 Year
ENE-279-2	RF cable	Rosenberger	L17-C001-3500	/	June 01, 2022	1 Year
ENE-279-3	RF cable	Rosenberger	L17-C001-1500	/	June 01, 2022	1 Year
ENE-279-4	RF cable	Rosenberger	/	/	June 01, 2022	1 Year
ENE-279-5	RF cable	Rosenberger	/	/	June 01, 2022	1 Year
ENE-279-6	RF cable	Rosenberger	L08-C446-1500	/	June 01, 2022	1 Year
ENE-283	RF cable	Rosenberger	LU7-C1511-1200	/	June 01, 2022	1 Year

### 3.4. For Radiated Emission Measurement (Above 1 GHz)

Equ. No.	Equipment	Manufacturer	Model No.	Serial No.	Last Cal.	Cal. Interval
ENE-171	EXA Signal Analyzer	KEYSIGHT	N9010B	MY60242467	March 01, 2022	1 Year
ENE-191	Horn antenna	Schwarzbeck	BBHA 9120 D	02588	May 27, 2022	2 Year
ENE-198	Pre-amplifier	JS Denki	PA0118-50	JSPA21022	May 27, 2022	1 Year
ENE-193	Horn antenna	Schwarzbeck	BBHA 9170	01190	May 27, 2022	2 Year
ENE-199	Pre-amplifier	JS Denki	PA1840-55	JSPA21023	May 27, 2022	1 Year
ENE-279-1	RF cable	Rosenberger	L17-C001-7000	/	June 01, 2022	1 Year
ENE-281-1	RF cable	Rosenberger	L17-C001-3500	/	June 01, 2022	1 Year
ENE-281-2	RF cable	Rosenberger	L17-C001-1500	/	June 01, 2022	1 Year
ENE-282-1	RF cable	Rosenberger	LA2-C125-3500	/	June 01, 2022	1 Year
ENE-282-2	RF cable	Rosenberger	LA2-C125-1500	/	June 01, 2022	1 Year
ENE-283	RF cable	Rosenberger	LU7-C1511-1200	/	June 01, 2022	1 Year

### 3.5. For Harmonic Current/Flicker Measurement

Equ. No.	Equipment	Manufacturer	Model No.	Serial No.	Last Cal.	Cal. Interval
ENE-048	AC Power source	California Instruments	5001iX-CTS-400-413	59739	July 07, 2022	1 Year
ENE-049	Harmonic/ flicker analyzer	California Instruments	PACS-1	72795	July 07, 2022	1 Year
ENE-157	Harmonic/ flicker analyzer	PACIFIC	ECTS2-3300 Z-M18012	550128	Dec.20, 2021	1 Year
ENE-157-1	AC Power source	PACIFIC	330AZX-CE	140250014	Dec.20, 2021	1 Year

### 3.6. For Electrostatic Discharge Immunity Test

Equ. No.	Equipment	Manufacturer	Model No.	Serial No.	Last Cal.	Cal. Interval
ENE-139	ESD Tester	TESEQ	NSG 437	1732	Nov. 30, 2022	1 Year

### 3.7. For RF Strength Susceptibility Test

Equ. No.	Equipment	Manufacturer	Model No.	Serial No.	Last Cal.	Cal. Interval
ENE-173	RF Signal generator/RF	Keysight	N5171B	MY61252820	April 28, 2022	1 Year
ENE-174	SW-RF	JS Denki	JSDSW-BS02	JSDSW2120 D01	April 28, 2022	1 Year
ENE-175	Power Amplifier	Vectawave	VBA 1000-600c	132035	April 28, 2022	1 Year
ENE-176	Power Amplifier	Vectawave	VBA 1060-200	132120	April 28, 2022	1 Year
ENE-177	Directional couplers	Bonn	BDC 0810-50/1500	2129259-01	April 28, 2022	1 Year
ENE-178	Directional couplers	Bonn	BDC 1060-40/500	2129304-03	April 28, 2022	1 Year
ENE-179	Multilayer periodic antenna	Schwarzbeck	STLP9129-7/16	03043	April 28, 2022	1 Year
ENE-180	RF cable	Times	LMR600-UF-4M	611747-0001	April 28, 2022	1 Year
ENE-180-1	RF cable	Times	LMR600-UF-1.5M	/	April 28, 2022	1 Year
ENE-181	RF cable	Times	LMR600-UF-4M	611748-0001	April 28, 2022	1 Year
ENE-181-1	RF cable	Times	LMR600-UF-1.5M	/	April 28, 2022	1 Year
ENE-182	power meter	Lumiloop	LSPM	86	April 28, 2022	1 Year

### 3.8. For Electrical Fast Transient /Burst Immunity Test

Equ. No.	Equipment	Manufacturer	Model No.	Serial No.	Last Cal.	Cal. Interval
ENE-011	Burst Tester	HAEFELY	PEFT4010	173964	July 07, 2022	1 Year
ENE-012	Coupling Clamp	HAEFELY	IP-4A	147399	July 07, 2022	1 Year
ENE-168	Coupling and Decoupling Network Three Phase	HAEFELY	FP-EFT 32M	190170	Jan. 10, 2022	1 Year

### 3.9. For Surge Immunity Test

Equ. No.	Equipment	Manufacturer	Model No.	Serial No.	Last Cal.	Cal. Interval
ENE-097-1	Combination Wave Generator	HTEC	HCWG 100	204303	Dec. 20, 2021	1 Year
ENE-097-2	Three Phase Coupling/Decoupling Network	HTEC	HCOUPLER 30S	204103	Dec. 20, 2021	1 Year
ENE-097-3	High Pressure Option	HTEC	Options-10K DC	/	Dec. 20, 2021	1 Year
ENE-097-4	40 ohm Impedance	HTEC	Options-40ohm	/	Dec. 20, 2021	1 Year
ENE-097-5	10 ohm Impedance	HTEC	Options-10ohm	/	Dec. 20, 2021	1 Year
ENE-097-6	Combination Wave Generator	HTEC	HTSG 70	204304	Dec. 20, 2021	1 Year
ENE-097-7	Coupling Network	HTEC	HCN 8	204901	Dec. 20, 2021	1 Year
ENE-097-8	Decoupling Network	HTEC	HDEC 8	204902	Dec. 20, 2021	1 Year
ENE-097-9	Isolated Power Supply	HTEC	SBK-30KVA	/	Dec. 20, 2021	1 Year

### 3.10. For Injected Current Susceptibility Test

Equ. No.	Equipment	Manufacturer	Model No.	Serial No.	Last Cal.	Cal. Interval
ENE-057	Simulator	SCHLODER	CDG-6000-7 5	126B1404/20 16	July 07, 2022	1 Year
ENE-058	CDN	SCHLODER	CDN-M2+3	A2210415/20 16	July 07, 2022	1 Year
ENE-056	Attenuator	SCHLODER	6dB 100W	HA1615	July 07, 2022	1 Year
ENE-098	Current Injection Probe	SCHLODER	CDN BCI-P1	19102314-01 01	Dec. 20, 2021	1 Year
ENE-099	EM-clamp	SCHLODER	CDN EMCL-20	20102817-01 03	Dec. 20, 2021	1 Year
ENE-160	Three phase coupled decoupling network	SCHLODER	CDN M3-L32 HV	10749-1	Dec. 20, 2021	1 Year
ENE-160-1	Three phase coupled decoupling network	SCHLODER	CDN M5-N32 HV	10751-1	Dec. 20, 2021	1 Year
ENE-160-2	Three phase coupled decoupling network	SCHLODER	CDN M4-32 HV	10750-1	Dec. 20, 2021	1 Year
ENE-160-3	Three phase CDN	SCHLODER	CDN M4-32A	10982-1	May. 18, 2022	1 Year

### 3.11. For Voltage Dips and Interruptions Test

Equ. No.	Equipment	Manufacturer	Model No.	Serial No.	Last Cal.	Cal. Interval
ENE-055	Dips Tester	HTEC	HPFS161P	164901	July 07, 2022	1 Year
ENE-055	AC Power source	HTEC	HV1P16T	164902	July 07, 2022	1 Year

## 4. CONDUCTED EMISSIONS FROM THE AC MAINS POWER PORTS

### 4.1. Block Diagram of Test Setup

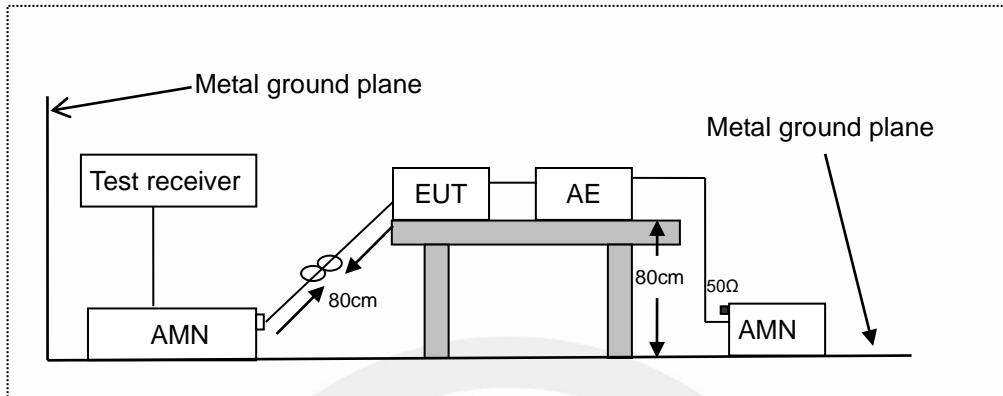

AMN: Artificial Mains Network  
 AE: Associated equipment  
 EUT: Equipment under test

### 4.2. Limits

BS EN 55032, Class B, Table A.10

Frequency range MHz	Coupling device (see Table A.8)	Detector type / bandwidth	Class B limits dB(μV)
0.15 to 0.5	AMN	Quasi Peak / 9 kHz	66 to 56
0.5 to 5			56
5 to 30			60
0.15 to 0.5	AMN	Average / 9 kHz	56 to 46
0.5 to 5			46
5 to 30			50

### 4.3. Test Procedure

The EUT was placed on a desk 0.8 m height from the metal ground plane and 0.4 m from the conducting wall of the shielding room and it was kept at least 0.8 m from any other grounded conducting surface. The size of the table will nominally be 1.5 m x1.0 m.

The rear of the arrangement shall be flush with the back of the supporting tabletop unless that would not be possible or typical of normal use.

All units of equipment forming the system under test (includes the EUT as well as connected peripherals and associated equipment or devices) shall be arranged such that a nominal 0.1 m separation is achieved between the neighboring units.

Connect EUT to the power mains through a artificial mains network (AMN). Where the mains cable supplied by the manufacturer is longer than 1 m, the excess should be folded at the centre into a bundle no longer than 0.4 m, so that its length is shortened to 1 m.



All the support units are connecting to the other AMN.

The AMN provides 50 ohm coupling impedance for the measuring instrument.

The CISPR states that the AMN with 50 ohm and 50 microhenry should be used.

Both sides of AC line were checked for maximum conducted interference.

The frequency range from 150 kHz to 30 MHz was sweep.

Set the test-receiver system to quasi peak detect function and average detect function, and to measure the conducted emissions values.

Test results were obtained from the following equation:

Measurement (dB $\mu$ V) = Correct Factor (dB) + Reading (dB $\mu$ V)

Over (dB) = Measurement (dB $\mu$ V) - Limit (dB $\mu$ V)

#### 4.4. Measuring Results

**Pass.**

Please refer to the following pages.

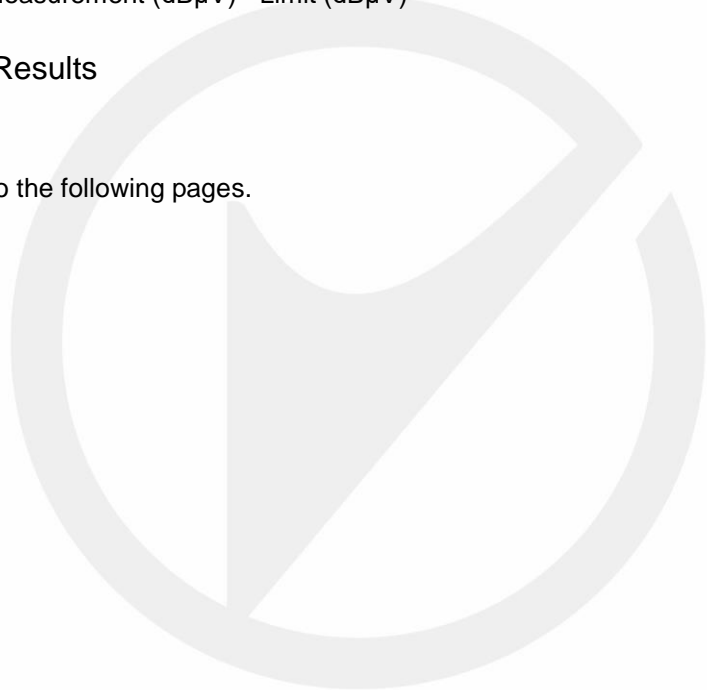

Project Information			
Mode:	ON	Voltage:	AC 120V/60Hz
Environment:	Temp: 24°C Humi:52%	Engineer:	Allen Tang

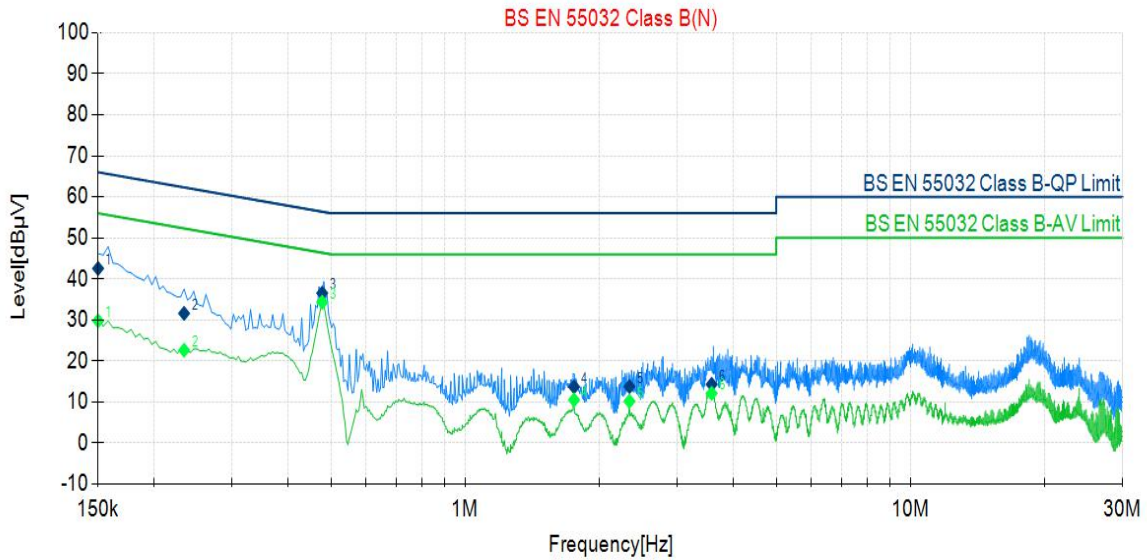

Final Data List											
NO.	Freq. [MHz]	Factor [dB]	QP Reading [dBµV]	QP Value [dBµV]	QP Limit [dBµV]	QP Margin [dB]	AV Reading [dBµV]	AV Value [dBµV]	AV Limit [dBµV]	AV Margin [dB]	Verdict
1	0.150	10.50	32.05	42.55	66.00	23.45	19.28	29.78	56.00	26.22	Pass
2	0.234	10.45	21.16	31.61	62.31	30.70	12.18	22.63	52.31	29.68	Pass
3	0.478	10.41	26.13	36.54	56.37	19.83	23.91	34.32	46.37	12.05	Pass
4	1.758	10.54	3.15	13.69	56.00	42.31	-0.03	10.51	46.00	35.49	Pass
5	2.342	10.59	3.19	13.78	56.00	42.22	-0.41	10.18	46.00	35.82	Pass
6	3.582	10.69	3.61	14.30	56.00	41.70	1.43	12.12	46.00	33.88	Pass

Project Information			
Mode:	ON	Voltage:	AC 120V/60Hz
Environment:	Temp: 24°C Humi:52%	Engineer:	Allen Tang

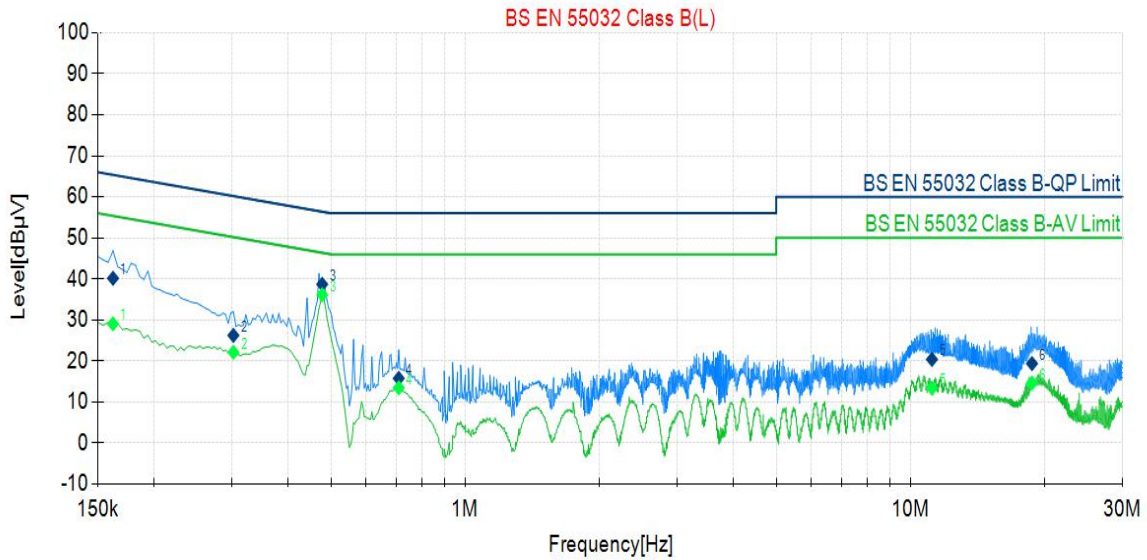

Final Data List											
NO.	Freq. [MHz]	Factor [dB]	QP Reading [dBµV]	QP Value [dBµV]	QP Limit [dBµV]	QP Margin [dB]	AV Reading [dBµV]	AV Value [dBµV]	AV Limit [dBµV]	AV Margin [dB]	Verdict
1	0.162	10.51	29.64	40.15	65.36	25.21	18.55	29.06	55.36	26.30	Pass
2	0.302	10.47	15.77	26.24	60.19	33.95	11.65	22.12	50.19	28.07	Pass
3	0.478	10.40	28.29	38.69	56.37	17.68	25.72	36.12	46.37	10.25	Pass
4	0.710	10.34	5.42	15.76	56.00	40.24	3.11	13.45	46.00	32.55	Pass
5	11.190	10.67	9.72	20.39	60.00	39.61	2.69	13.36	50.00	36.64	Pass
6	18.774	10.73	8.63	19.36	60.00	40.64	3.91	14.64	50.00	35.36	Pass

Project Information			
Mode:	ON	Voltage:	AC 230V/50Hz
Environment:	Temp: 24°C Humi:52%	Engineer:	Allen Tang

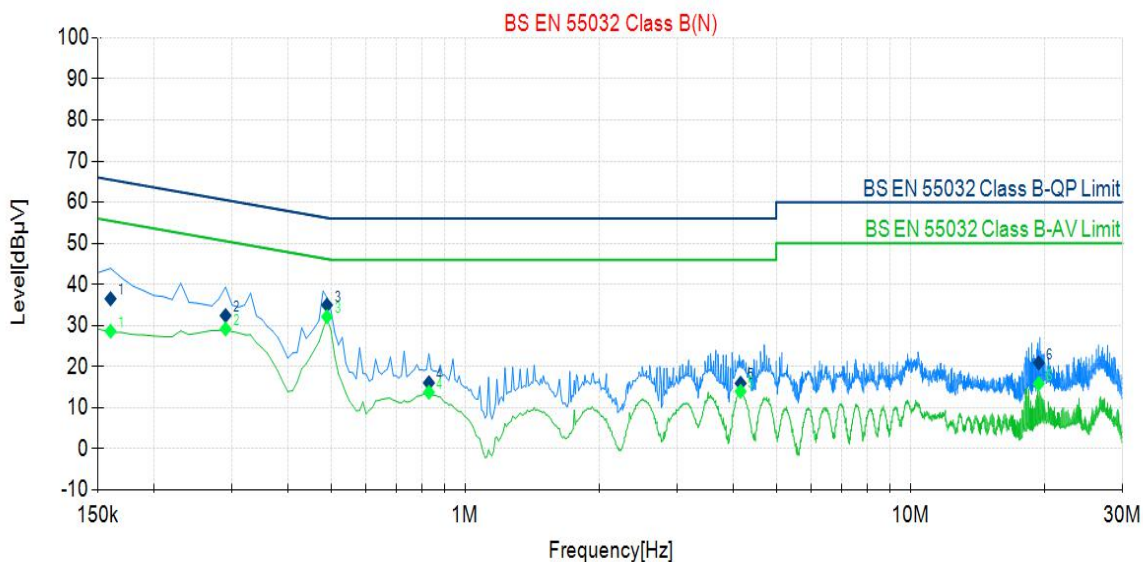

Final Data List											
NO.	Freq. [MHz]	Factor [dB]	QP Reading [dBµV]	QP Value [dBµV]	QP Limit [dBµV]	QP Margin [dB]	AV Reading [dBµV]	AV Value [dBµV]	AV Limit [dBµV]	AV Margin [dB]	Verdict
1	0.160	10.49	26.01	36.50	65.46	28.96	18.12	28.61	55.46	26.85	Pass
2	0.290	10.43	21.99	32.42	60.52	28.10	18.71	29.14	50.52	21.38	Pass
3	0.490	10.42	24.55	34.97	56.17	21.20	21.72	32.14	46.17	14.03	Pass
4	0.830	10.49	5.55	16.04	56.00	39.96	3.25	13.74	46.00	32.26	Pass
5	4.160	10.70	5.23	15.93	56.00	40.07	3.27	13.97	46.00	32.03	Pass
6	19.440	10.85	10.06	20.91	60.00	39.09	4.98	15.83	50.00	34.17	Pass

P Project Information			
Mode:	ON	Voltage:	AC 230V/50Hz
Environment:	Temp: 24°C Humi:52%	Engineer:	Allen Tang

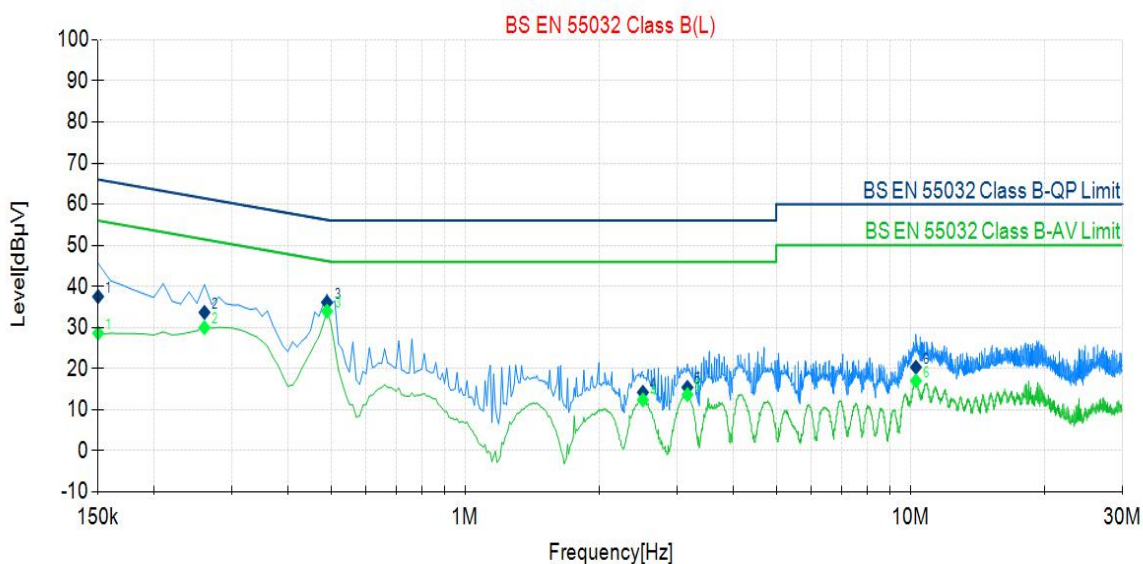

Final Data List											
NO.	Freq. [MHz]	Factor [dB]	QP Reading [dBµV]	QP Value [dBµV]	QP Limit [dBµV]	QP Margin [dB]	AV Reading [dBµV]	AV Value [dBµV]	AV Limit [dBµV]	AV Margin [dB]	Verdict
1	0.150	10.51	27.01	37.52	66.00	28.48	18.10	28.61	56.00	27.39	Pass
2	0.260	10.48	23.19	33.67	61.43	27.76	19.48	29.96	51.43	21.47	Pass
3	0.490	10.39	25.72	36.11	56.17	20.06	23.56	33.95	46.17	12.22	Pass
4	2.510	10.43	3.78	14.21	56.00	41.79	1.94	12.37	46.00	33.63	Pass
5	3.160	10.44	4.98	15.42	56.00	40.58	3.21	13.65	46.00	32.35	Pass
6	10.300	10.67	9.66	20.33	60.00	39.67	6.33	17.00	50.00	33.00	Pass

## 5. ASYMMETRIC MODE CONDUCTED EMISSIONS AT WIRED NETWORK PORTS

### 5.1. Block Diagram of Test Setup

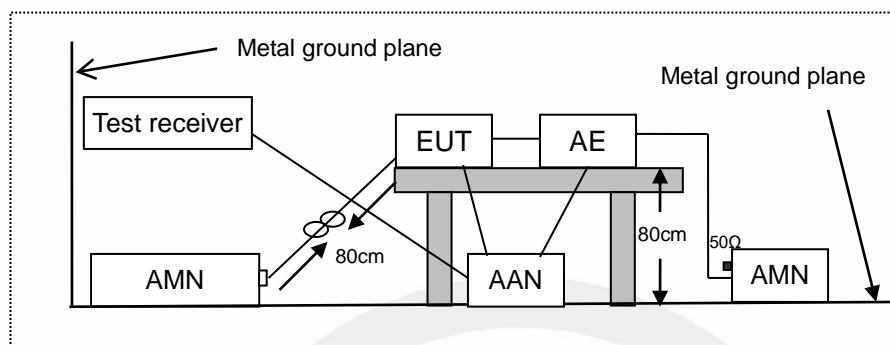

AMN: Artificial mains network  
 AE: Associated equipment  
 EUT: Equipment under test  
 AAN: Asymmetric artificial network

### 5.2. Limits

BS EN 55032, Class B, Table A.12

Frequency range (MHz)	Coupling device (see Table A.8)	Detector type / bandwidth	Class B voltage limits dB(μV)	Class B current limits dB(μA)
0.15 to 0.5	AAN	Quasi Peak / 9 kHz	84 to 74	N/A
0.5 to 30			74	
0.15 to 0.5	AAN	Average / 9 kHz	74 to 64	
0.5 to 30			64	
0.15 to 0.5	CVP and current probe	Quasi Peak / 9 kHz	84 to 74	40 to 30
0.5 to 30			74	30
0.15 to 0.5	CVP and current probe	Average / 9 kHz	74 to 64	30 to 20
0.5 to 30			64	20
0.15 to 0.5	Current Probe	Quasi Peak / 9 kHz	N/A	40 to 30
0.5 to 30				30
0.15 to 0.5	Current Probe	Average / 9 kHz		30 to 20
0.5 to 30				20

### 5.3. Test Procedure

The EUT is put on the plane 0.8m high above the ground by insulating support and connected to the AC mains through artificial mains network(AMN) or connected to the wired network port through an asymmetric artificial network(AAN). AMN provided a 50ohm coupling impedance for the tested equipment AC mains port, ANN provided a common mode (asymmetric mode) impedance of 150 Ω to the wired network port under test. Both sides of AC line and the wired network line are investigated to

find out the maximum conducted emission according to the BS EN 55032 regulations during conducted emission measurement.

The bandwidth of the receiver is set at 9 kHz in 150 kHz~30 MHz. The frequency range from 150 kHz to 30 MHz is investigated.

Test results were obtained from the following equation:

Measurement (dB $\mu$ V) = Correct Factor (dB) + Reading (dB $\mu$ V)

Over (dB) = Measurement (dB $\mu$ V) - Limit (dB $\mu$ V)

#### 5.4. Measuring Results

**Pass.**

Please refer to the following pages.



Project Information			
Mode:	ON	Voltage:	AC 120V/60Hz
Environment:	Temp: 24°C Humi:52%	Engineer:	Allen Tang

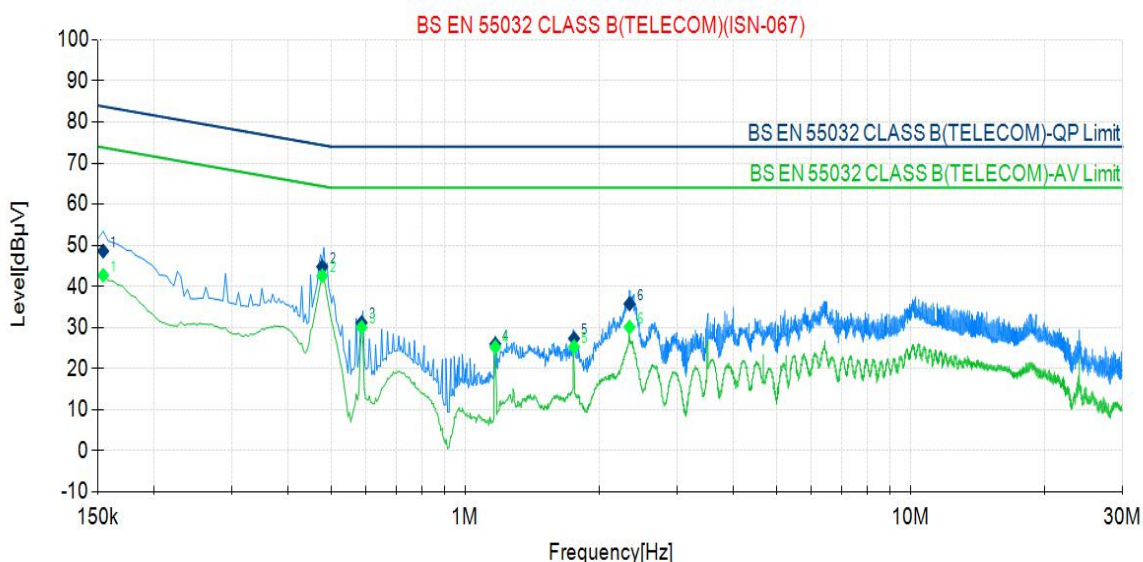

Final Data List											
NO.	Freq. [MHz]	Factor [dB]	QP Reading [dBµV]	QP Value [dBµV]	QP Limit [dBµV]	QP Margin [dB]	AV Reading [dBµV]	AV Value [dBµV]	AV Limit [dBµV]	AV Margin [dB]	Verdict
1	0.154	10.06	38.52	48.58	83.78	35.20	32.65	42.71	73.78	31.07	Pass
2	0.478	10.31	34.48	44.79	74.37	29.58	32.24	42.55	64.37	21.82	Pass
3	0.586	10.35	20.81	31.16	74.00	42.84	19.65	30.00	64.00	34.00	Pass
4	1.170	10.49	15.49	25.98	74.00	48.02	14.73	25.22	64.00	38.78	Pass
5	1.758	10.52	16.80	27.32	74.00	46.68	14.78	25.30	64.00	38.70	Pass
6	2.342	10.55	25.21	35.76	74.00	38.24	19.55	30.10	64.00	33.90	Pass



Project Information			
Mode:	ON	Voltage:	AC 230V/50Hz
Environment:	Temp: 24°C Humi:52%	Engineer:	Allen Tang

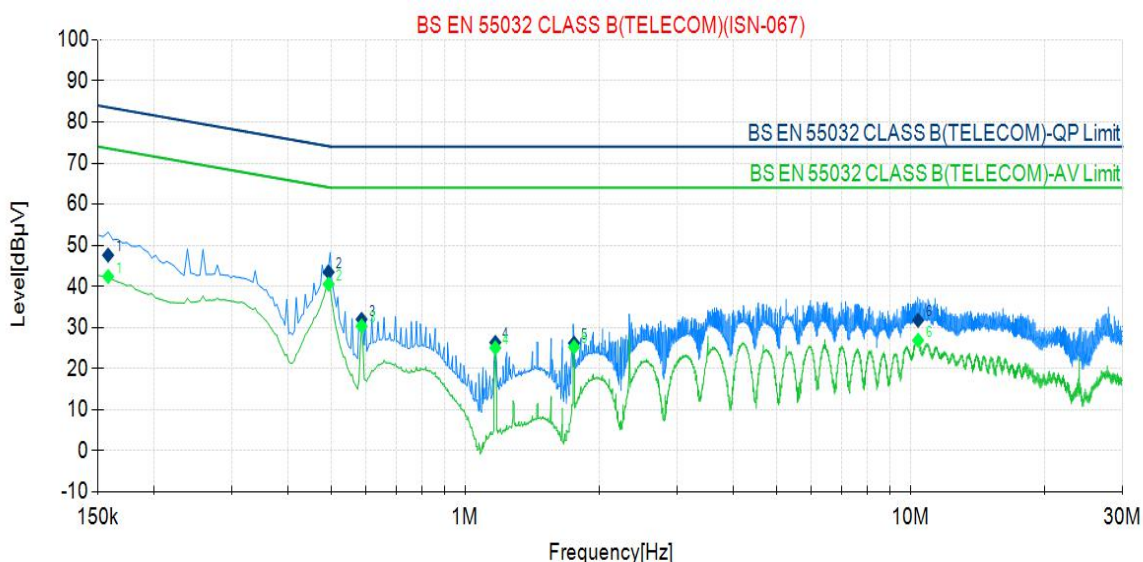

Final Data List											
NO.	Freq. [MHz]	Factor [dB]	QP Reading [dBµV]	QP Value [dBµV]	QP Limit [dBµV]	QP Margin [dB]	AV Reading [dBµV]	AV Value [dBµV]	AV Limit [dBµV]	AV Margin [dB]	Verdict
1	0.158	10.07	37.53	47.60	83.57	35.97	32.33	42.40	73.57	31.17	Pass
2	0.494	10.32	33.14	43.46	74.10	30.64	30.23	40.55	64.10	23.55	Pass
3	0.586	10.35	21.65	32.00	74.00	42.00	19.99	30.34	64.00	33.66	Pass
4	1.170	10.49	15.87	26.36	74.00	47.64	14.55	25.04	64.00	38.96	Pass
5	1.758	10.52	15.68	26.20	74.00	47.80	14.71	25.23	64.00	38.77	Pass
6	10.418	10.84	20.92	31.76	74.00	42.24	16.04	26.88	64.00	37.12	Pass

## 6. RADIATED EMISSION MEASUREMENT (UP TO 1GHz)

### 6.1. Block Diagram of Test Setup

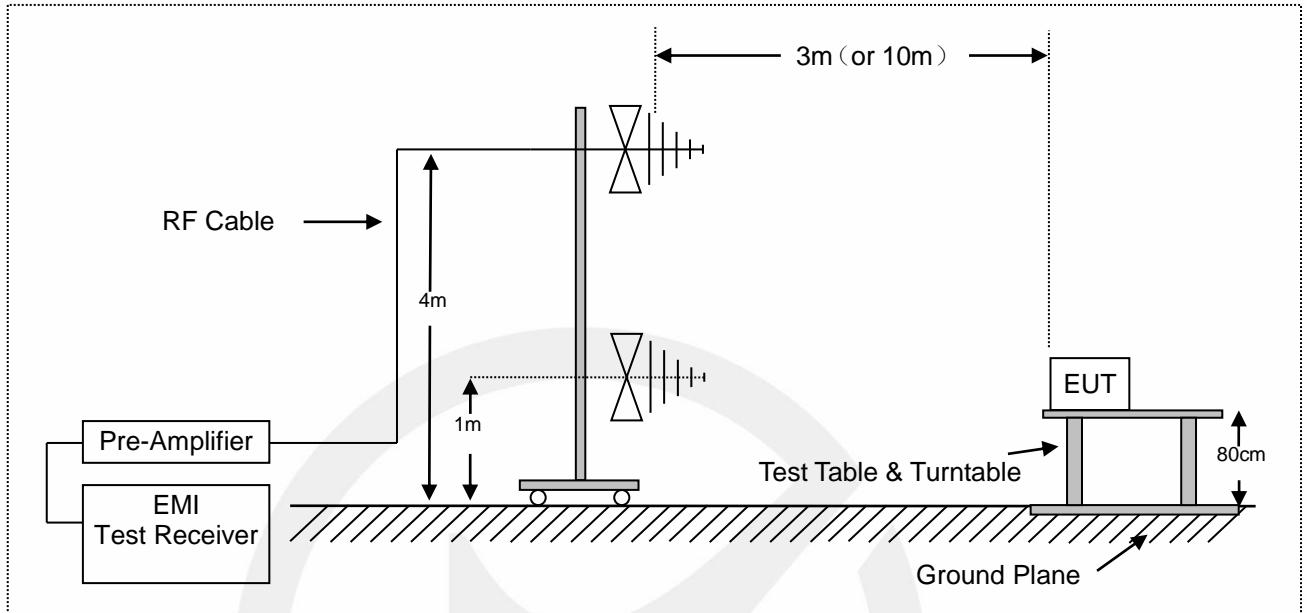

### 6.2. Radiated Limit

BS EN 55032, Class B, Table A.4

Frequency range MHz	Measurement			Class B limits dB(μV/m)
	Facility	Distance (m)	Detector type / bandwidth	
30 to 230	OATS/SAC	10	Quasi Peak / 120 kHz	30
230 to 1 000				37
30 to 230	OATS/SAC	3		40
230 to 1 000				47

### 6.3. Test Procedure

The EUT was placed on a non-conductive table whose total height equaled 80cm. All units of equipment forming the system under test (includes the EUT as well as connected peripherals and associated equipment or devices) shall be arranged such that a nominal 0.1 m separation is achieved between the neighboring units. Where the mains cable supplied by the manufacturer is longer than 1 m, the excess should be folded at the centre into a bundle no longer than 0.4 m, so that its length is shortened to 1 m.

The EUT was set 3 meters (or 10 meters) away from the receiving antenna that was mounted on a non-conductive mast. The antenna can move up and down between 1 to 4 meters to find out the maximum emission level.

The turntable can rotate 360 degree to determine the position of the maximum emission level.

The initial testing identified the frequency that has the highest disturbance relative to the limit while operating the EUT in typical modes of operation and cable positions in a test setup representative of typical system configuration.

The identification of the frequency of highest emission with respect to the limit was found by investigating emissions at a number of significant frequencies. The probable frequency of maximum emission had been found and that the associated cable and EUT configuration and mode of operation had been identified.

The bandwidth of the Receiver is set at 120 kHz.

Test results were obtained from the following equation:

Measurement (dB $\mu$ V) = Correct Factor (dB) + Reading (dB $\mu$ V)

Over (dB) = Measurement (dB $\mu$ V) - Limit (dB $\mu$ V)

#### 6.4. Measuring Results

**Pass.**

Please refer to the following pages.

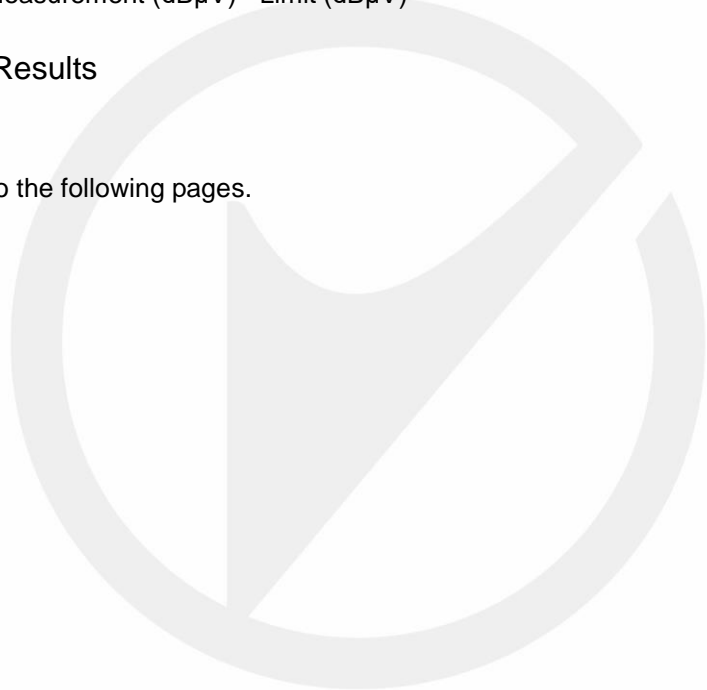

Project Information			
Mode:	ON	Voltage:	AC 120V/60Hz
Environment:	Temp: 25°C; Humi:60%	Engineer:	JACK ZHANG

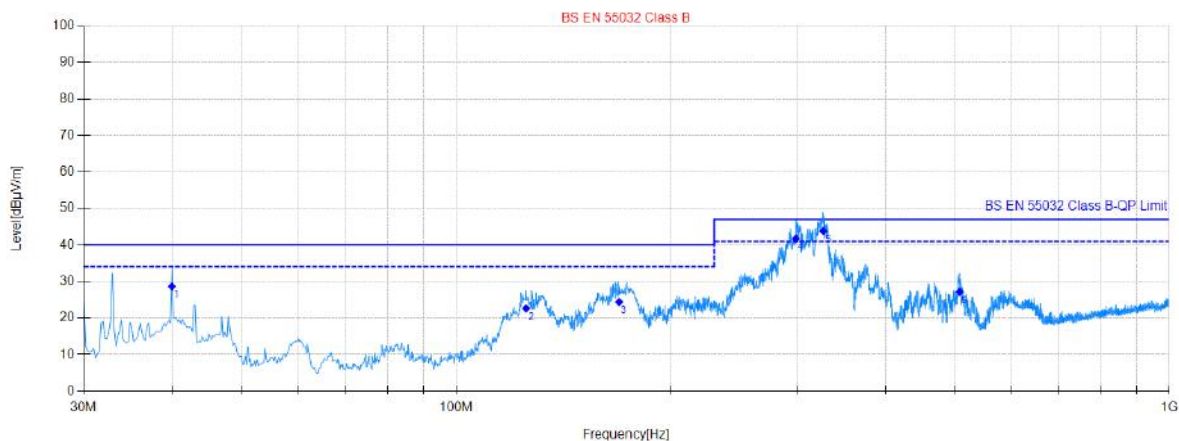

Final Data List										
NO.	Freq. [MHz]	QP Reading [dBµV/m]	Factor [dB]	QP Value [dBµV/m]	QP Limit [dBµV/m]	QP Margin [dB]	Height [cm]	Angle [°]	Polarity	Verdict
1	39.896	59.81	-31.18	28.63	40.00	11.37	100	144	Horizontal	Pass
2	125.273	56.00	-33.39	22.61	40.00	17.39	200	187	Horizontal	Pass
3	169.126	57.04	-32.65	24.39	40.00	15.61	200	325	Horizontal	Pass
4	299.326	70.09	-28.38	41.71	47.00	5.29	100	123	Horizontal	Pass
5	327.073	70.94	-27.14	43.80	47.00	3.20	100	144	Horizontal	Pass
6	507.918	50.32	-23.15	27.17	47.00	19.83	100	236	Horizontal	Pass

Project Information			
Mode:	ON	Voltage:	AC 120V/60Hz
Environment:	Temp: 25°C; Humi:60%	Engineer:	JACK ZHANG

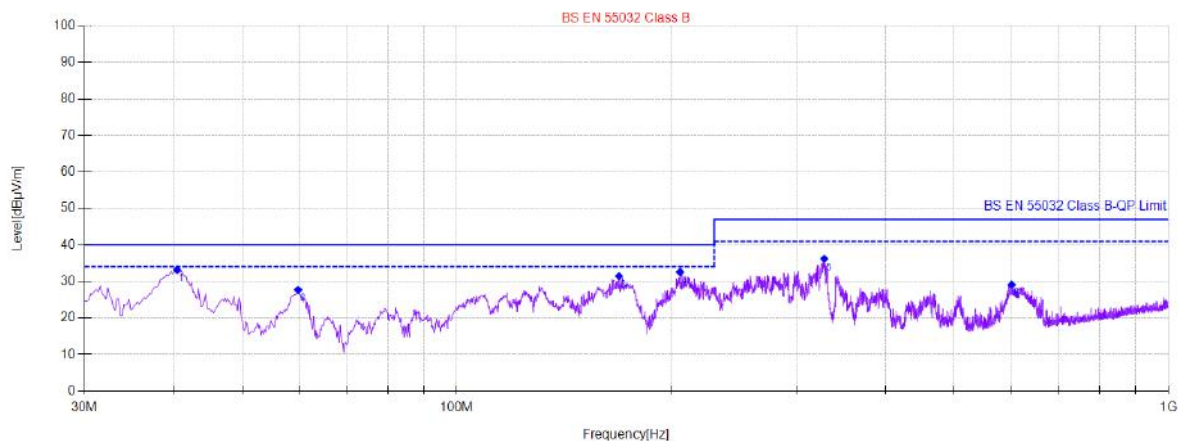

Final Data List										
NO.	Freq. [MHz]	QP Reading [dBµV/m]	Factor [dB]	QP Value [dBµV/m]	QP Limit [dBµV/m]	QP Margin [dB]	Height [cm]	Angle [°]	Polarity	Verdict
1	40.478	64.27	-31.08	33.19	40.00	6.81	100	68	Horizontal	Pass
2	59.882	59.77	-32.09	27.68	40.00	12.32	100	287	Horizontal	Pass
3	169.126	64.11	-32.65	31.46	40.00	8.54	100	312	Horizontal	Pass
4	205.993	63.16	-30.58	32.58	40.00	7.42	100	350	Horizontal	Pass
5	328.432	63.34	-27.14	36.20	47.00	10.80	100	92	Horizontal	Pass
6	602.220	49.96	-20.83	29.13	47.00	17.87	100	186	Horizontal	Pass

Project Information			
Mode:	ON	Voltage:	AC 230V/50Hz
Environment:	Temp: 25°C; Humi:60%	Engineer:	JACK ZHANG

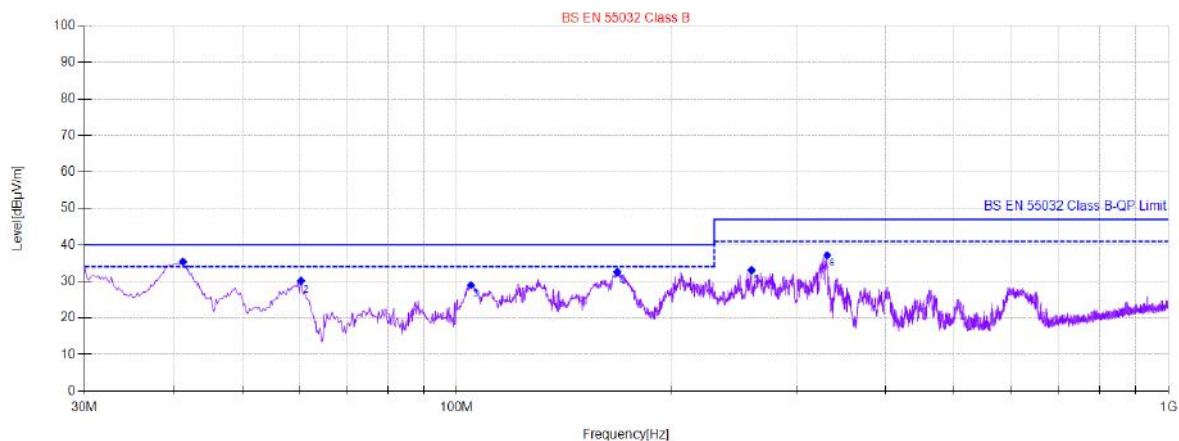

Final Data List										
NO.	Freq. [MHz]	QP Reading [dBµV/m]	Factor [dB]	QP Value [dBµV/m]	QP Limit [dBµV/m]	QP Margin [dB]	Height [cm]	Angle [°]	Polarity	Verdict
1	41.254	66.32	-30.91	35.41	40.00	4.59	100	105	Vertical	Pass
2	60.464	62.28	-32.14	30.14	40.00	9.86	100	348	Vertical	Pass
3	104.705	60.25	-31.28	28.97	40.00	11.03	100	360	Vertical	Pass
4	168.156	65.26	-32.67	32.59	40.00	7.41	100	348	Vertical	Pass
5	259.548	61.74	-28.67	33.07	47.00	13.93	100	327	Vertical	Pass
6	331.536	64.33	-27.15	37.18	47.00	9.82	100	77	Vertical	Pass

Project Information			
Mode:	ON	Voltage:	AC 230V/50Hz
Environment:	Temp: 25°C; Humi:60%	Engineer:	JACK ZHANG



Final Data List										
NO.	Freq. [MHz]	QP Reading [dBµV/m]	Factor [dB]	QP Value [dBµV/m]	QP Limit [dBµV/m]	QP Margin [dB]	Height [cm]	Angle [°]	Polarity	Verdict
1	39.896	57.85	-31.18	26.67	40.00	13.33	100	192	Horizontal	Pass
2	131.288	56.35	-33.64	22.71	40.00	17.29	200	34	Horizontal	Pass
3	168.932	59.35	-32.65	26.70	40.00	13.30	200	301	Horizontal	Pass
4	299.520	69.64	-28.38	41.26	47.00	5.74	100	168	Horizontal	Pass
5	329.208	70.24	-27.15	43.09	47.00	3.91	100	130	Horizontal	Pass
6	508.500	50.04	-23.14	26.90	47.00	20.10	100	217	Horizontal	Pass

## 7. RADIATED EMISSION MEASUREMENT (ABOVE 1GHz)

### 7.1. Block Diagram of Test Setup

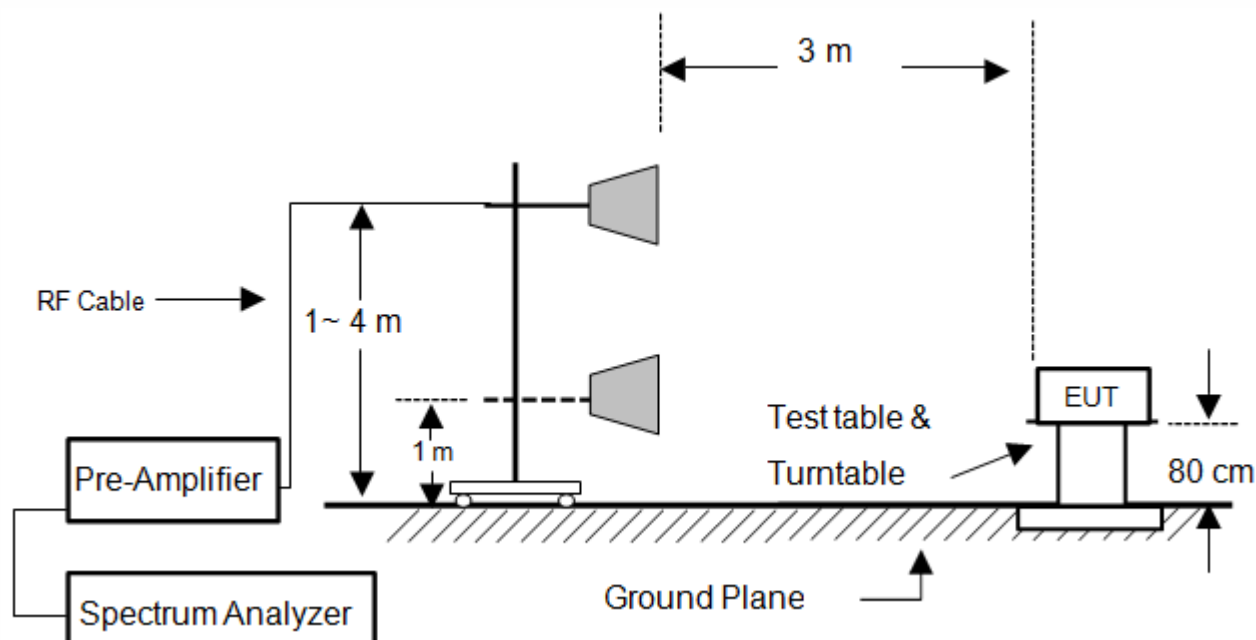

### 7.2. Radiated Limit

BS EN 55032, Class B, Table A.5

Frequency range (MHz)	Measurement			Class B limits dB( $\mu$ V/m)
	Facility	Distance (m)	Detector type/ bandwidth	
1000 to 6000	FSOATS	3	Average / 1 MHz	54
1000 to 6000			Peak / 1 MHz	74

Note: The highest internal source of an EUT is defined as the highest frequency generated or used within the EUT or on which the EUT operates or tunes. If the highest frequency of the internal sources of the EUT is less than 108 MHz, the measurement shall only be made up to 1 GHz. If the highest frequency of the internal sources of the EUT is between 108 MHz and 500 MHz the measurement shall only be made up to 2 GHz. If the highest frequency of the internal sources of the EUT is between 500 MHz and 1 GHz, the measurement shall only be made up to 5 GHz. If the highest frequency of the internal sources of the EUT is above 1 GHz, the measurement shall be made up to 5 times the highest frequency or 6 GHz, whichever is less.



### 7.3. Test Procedure

The EUT was placed on a non-conductive table whose total height equaled 80cm. All units of equipment forming the system under test (includes the EUT as well as connected peripherals and associated equipment or devices) shall be arranged such that a nominal 0.1 m separation is achieved between the neighboring units. Where the mains cable supplied by the manufacturer is longer than 1 m, the excess should be folded at the centre into a bundle no longer than 0.4 m, so that its length is shortened to 1 m.

The EUT was set 3 meters away from the receiving antenna that was mounted on a non-conductive mast. The antenna can move up and down between 1 to 4 meters to find out the maximum emission level.

The turntable can rotate 360 degree to determine the position of the maximum emission level.

The initial testing identified the frequency that has the highest disturbance relative to the limit while operating the EUT in typical modes of operation and cable positions in a test setup representative of typical system configuration.

The identification of the frequency of highest emission with respect to the limit was found by investigating emissions at a number of significant frequencies. The probable frequency of maximum emission had been found and that the associated cable and EUT configuration and mode of operation had been identified.

The frequency range above 1GHz the measuring instrument use RBW=1 MHz and VBW=3 MHz.

Test results were obtained from the following equation:  
Measurement (dB $\mu$ V) = Correct Factor (dB) + Reading (dB $\mu$ V)  
Over (dB) = Measurement (dB $\mu$ V) - Limit (dB $\mu$ V)

### 7.4. Measuring Results

**Pass.**

Please refer to the following pages.

Project Information			
Mode:	ON	Voltage:	AC 230V/50Hz
Environment:	Temp: 24°C; Humi:58%	Engineer:	JACK ZHANG

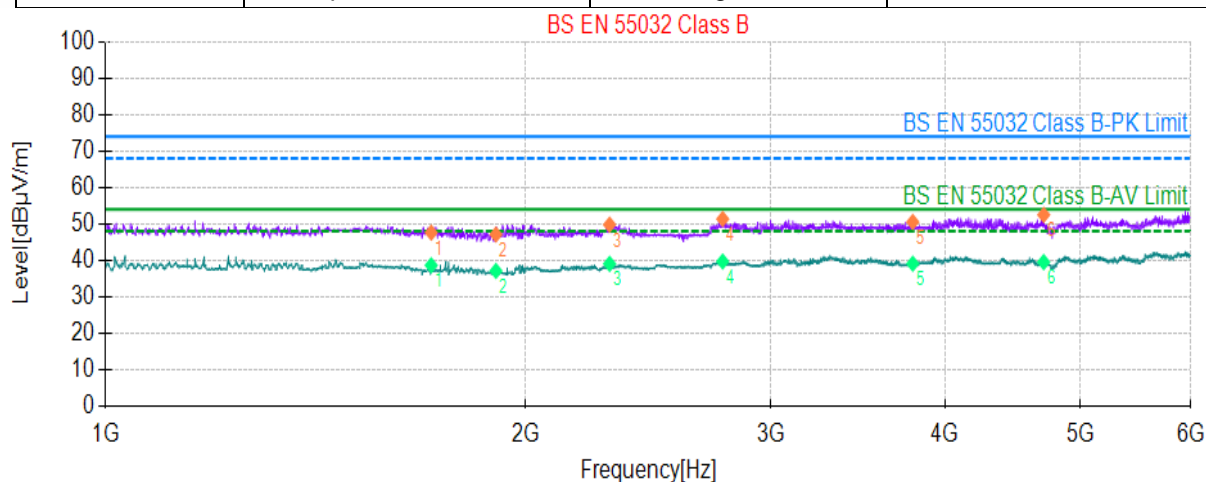

PK Final Data List										
NO.	Freq. [MHz]	PK Reading [dBµV/m]	Factor [dB]	PK Value [dBµV/m]	PK Limit [dBµV/m]	PK Margin [dB]	Height [cm]	Angle [°]	Polarity	Verdict
1	1712.142	61.46	-13.90	47.56	74.00	26.44	100	52	Vertical	Pass
2	1905.181	60.78	-13.71	47.07	74.00	26.93	100	77	Vertical	Pass
3	2298.260	63.06	-13.30	49.76	74.00	24.24	100	163	Vertical	Pass
4	2770.354	62.76	-11.42	51.34	74.00	22.66	100	81	Vertical	Pass
5	3791.558	58.76	-8.25	50.51	74.00	23.49	100	44	Vertical	Pass
6	4706.741	58.67	-6.21	52.46	74.00	21.54	100	120	Vertical	Pass

AV Final Data List										
NO.	Freq. [MHz]	AV Reading [dBµV/m]	Factor [dB]	AV Value [dBµV/m]	AV Limit [dBµV/m]	AV Margin [dB]	Height [cm]	Angle [°]	Polarity	Verdict
1	1712.142	52.49	-13.90	38.59	54.00	15.41	100	52	Vertical	Pass
2	1905.181	50.78	-13.71	37.07	54.00	16.93	100	77	Vertical	Pass
3	2298.260	52.29	-13.30	38.99	54.00	15.01	100	163	Vertical	Pass
4	2770.354	51.07	-11.42	39.65	54.00	14.35	100	81	Vertical	Pass
5	3791.558	47.29	-8.25	39.04	54.00	14.96	100	44	Vertical	Pass
6	4706.741	45.69	-6.21	39.48	54.00	14.52	100	120	Vertical	Pass

Project Information			
Mode:	ON	Voltage:	AC 230V/50Hz
Environment:	Temp: 24°C; Humi:58%	Engineer:	JACK ZHANG

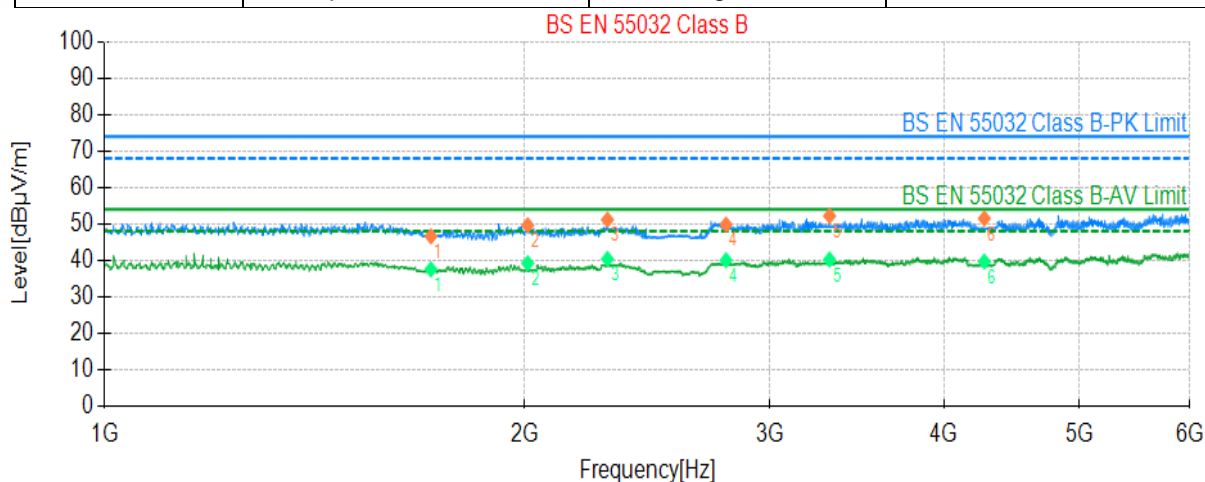

PK Final Data List										
NO.	Freq. [MHz]	PK Reading [dBµV/m]	Factor [dB]	PK Value [dBµV/m]	PK Limit [dBµV/m]	PK Margin [dB]	Height [cm]	Angle [°]	Polarity	Verdict
1	1714.143	60.46	-13.90	46.56	74.00	27.44	100	105	Horizontal	Pass
2	2011.202	63.21	-13.61	49.60	74.00	24.40	100	116	Horizontal	Pass
3	2294.259	64.43	-13.31	51.12	74.00	22.88	100	181	Horizontal	Pass
4	2790.358	61.09	-11.29	49.80	74.00	24.20	100	358	Horizontal	Pass
5	3310.462	61.67	-9.50	52.17	74.00	21.83	100	83	Horizontal	Pass
6	4274.655	58.64	-7.17	51.47	74.00	22.53	100	314	Horizontal	Pass

AV Final Data List										
NO.	Freq. [MHz]	AV Reading [dBµV/m]	Factor [dB]	AV Value [dBµV/m]	AV Limit [dBµV/m]	AV Margin [dB]	Height [cm]	Angle [°]	Polarity	Verdict
1	1714.143	51.39	-13.90	37.49	54.00	16.51	100	105	Horizontal	Pass
2	2011.202	52.78	-13.61	39.17	54.00	14.83	100	116	Horizontal	Pass
3	2294.259	53.64	-13.31	40.33	54.00	13.67	100	181	Horizontal	Pass
4	2790.358	51.27	-11.29	39.98	54.00	14.02	100	358	Horizontal	Pass
5	3310.462	49.69	-9.50	40.19	54.00	13.81	100	83	Horizontal	Pass
6	4274.655	46.79	-7.17	39.62	54.00	14.38	100	314	Horizontal	Pass

Project Information			
Mode:	ON	Voltage:	AC 120V/60Hz
Environment:	Temp: 24°C; Humi:58%	Engineer:	JACK ZHANG

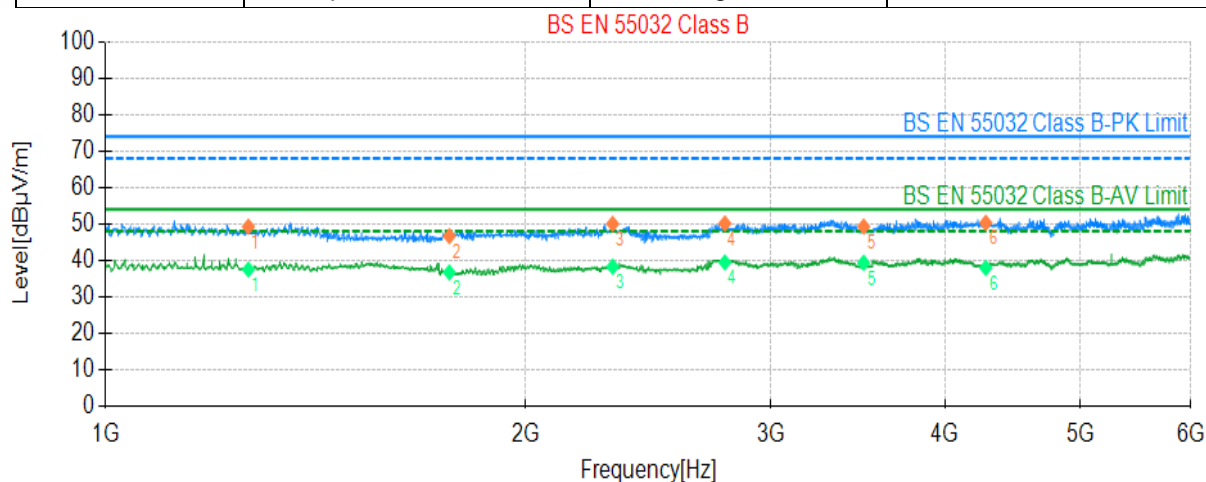

PK Final Data List										
NO.	Freq. [MHz]	PK Reading [dBµV/m]	Factor [dB]	PK Value [dBµV/m]	PK Limit [dBµV/m]	PK Margin [dB]	Height [cm]	Angle [°]	Polarity	Verdict
1	1266.053	63.26	-14.06	49.20	74.00	24.80	100	170	Horizontal	Pass
2	1764.153	60.46	-13.85	46.61	74.00	27.39	100	27	Horizontal	Pass
3	2310.262	63.28	-13.29	49.99	74.00	24.01	100	80	Horizontal	Pass
4	2780.356	61.43	-11.36	50.07	74.00	23.93	100	0	Horizontal	Pass
5	3496.499	58.46	-9.20	49.26	74.00	24.74	100	263	Horizontal	Pass
6	4277.656	57.43	-7.17	50.26	74.00	23.74	100	40	Horizontal	Pass

AV Final Data List										
NO.	Freq. [MHz]	AV Reading [dBµV/m]	Factor [dB]	AV Value [dBµV/m]	AV Limit [dBµV/m]	AV Margin [dB]	Height [cm]	Angle [°]	Polarity	Verdict
1	1266.053	51.49	-14.06	37.43	54.00	16.57	100	170	Horizontal	Pass
2	1764.153	50.49	-13.85	36.64	54.00	17.36	100	27	Horizontal	Pass
3	2310.262	51.49	-13.29	38.20	54.00	15.80	100	80	Horizontal	Pass
4	2780.356	50.76	-11.36	39.40	54.00	14.60	100	0	Horizontal	Pass
5	3496.499	48.49	-9.20	39.29	54.00	14.71	100	263	Horizontal	Pass
6	4277.656	45.04	-7.17	37.87	54.00	16.13	100	40	Horizontal	Pass

Project Information			
Mode:	ON	Voltage:	AC 120V/60Hz
Environment:	Temp: 24°C; Humi:58%	Engineer:	JACK ZHANG

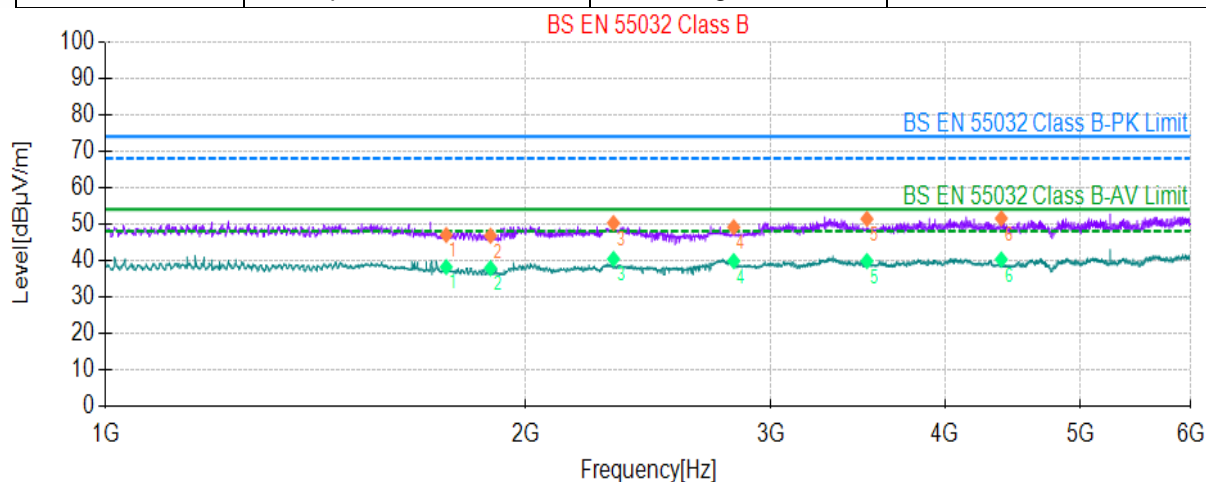

PK Final Data List										
NO.	Freq. [MHz]	PK Reading [dBµV/m]	Factor [dB]	PK Value [dBµV/m]	PK Limit [dBµV/m]	PK Margin [dB]	Height [cm]	Angle [°]	Polarity	Verdict
1	1755.151	60.79	-13.86	46.93	74.00	27.07	100	112	Vertical	Pass
2	1888.178	60.46	-13.73	46.73	74.00	27.27	100	354	Vertical	Pass
3	2313.263	63.49	-13.28	50.21	74.00	23.79	100	192	Vertical	Pass
4	2821.364	60.16	-11.10	49.06	74.00	24.94	100	195	Vertical	Pass
5	3515.503	60.49	-9.14	51.35	74.00	22.65	100	170	Vertical	Pass
6	4388.678	58.49	-7.00	51.49	74.00	22.51	100	332	Vertical	Pass

AV Final Data List										
NO.	Freq. [MHz]	AV Reading [dBµV/m]	Factor [dB]	AV Value [dBµV/m]	AV Limit [dBµV/m]	AV Margin [dB]	Height [cm]	Angle [°]	Polarity	Verdict
1	1755.151	51.98	-13.86	38.12	54.00	15.88	100	112	Vertical	Pass
2	1888.178	51.54	-13.73	37.81	54.00	16.19	100	354	Vertical	Pass
3	2313.263	53.61	-13.28	40.33	54.00	13.67	100	192	Vertical	Pass
4	2821.364	50.86	-11.10	39.76	54.00	14.24	100	195	Vertical	Pass
5	3515.503	48.89	-9.14	39.75	54.00	14.25	100	170	Vertical	Pass
6	4388.678	47.20	-7.00	40.20	54.00	13.80	100	332	Vertical	Pass

## 8. HARMONIC CURRENT EMISSION MEASUREMENT

### 8.1. Block Diagram of Test Setup

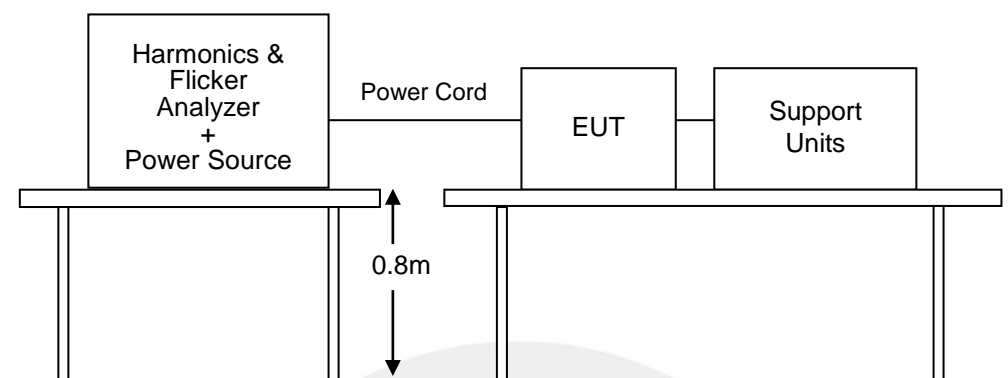

### 8.2. Standard Limits

BS EN IEC 61000-3-2, CLASS A

Harmonic current emissions evaluate the potential for the EUT to cause distortion on the AC power lines. It is applicable to electrical and electronic equipment having an input current  $\leq 16$  A per phase, and intended to be connected to public low-voltage distribution systems

Table 1 - Limits for Class A equipment

Harmonic order n	Maximum permissible harmonic current (A)
Odd harmonics	
3	2.30
5	1.14
7	0.77
9	0.40
11	0.33
13	0.21
$15 \leq n \leq 39$	$0.15 \frac{0.15}{n}$
Even harmonics	
2	1.08
4	0.43
6	0.30
$8 \leq n \leq 40$	$0.23 \frac{8}{n}$

### 8.3. Test Procedure

The measurement of harmonic currents shall be performed as follows: i. For each harmonic order, measure the 1.5 s smoothed r.m.s. harmonic current in each DFT time window as defined in EN / IEC 61000-4-7:2009. ii. Calculate the arithmetic average of the measured values from the DFT time windows, over the entire observation period Short cyclic ( $T \text{ cycle} \leq 2.5 \text{ min}$ ). Because of synchronisation to meet the requirements for repeatability in 5%.

### 8.4. Test Results

**Pass.**

Please refer to the following pages.



**EUT:** Adapter Box (Adapter Box G2)  
**Test Standard:** Test per IEC 61000-3-2 Ed. 5.1 : 2020  
**Test Class:** (Class A Test)  
**Test Result:** **PASS**  
**Test Date:** 2022/11/30  
**Start Time:** 13:30:38  
**Stop Time:** 13:33:19  
**Test Duration (min):** 2.5  
**Environment:** Temp: 25°C; Humi:45%  
**Source Qualification:** Compliance with IEC 61000-3-2 Ed. 5.1 : 2020  
**Power Source Distortion:** **OK**  
**Customer:** Customer  
**Test By:** Jo Liu  
**Comments:** ON

**General Test Data: (Phase A)**

Vrms (Volts)/V-pk/V-CF:	229.38 / 323.6 / 1.411	Frequency (Hz):	50.0001
I <sub>rms</sub> (Amps):	0.073	Power (VA)/VAR:	17.2 / 17.1
I <sub>fund</sub> /I <sub>ref</sub> (Amps):	0.035 / 0.035	Power (W):	0.8
I <sub>peak</sub> (Amps)/I-CF:	0.462 / 4.803	Power Factor:	0.060
V-THD (%):	0.06	I-THD (%):	42.31
POHC (A):	0.008 (method C.3)	POHC Limit (A):	0.250
I-THC (A):	0.015	Meas. Pwr (Min / Max) 0.5W/1.3W	
Phase angle of H5 (deg):	6.2		

**Harmonic Spectrum**

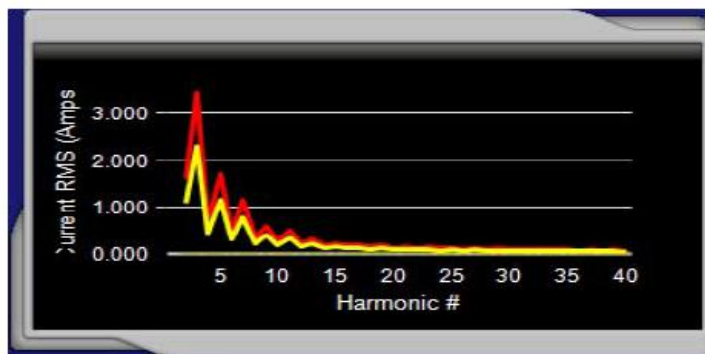

**Voltage & Current Waveform**

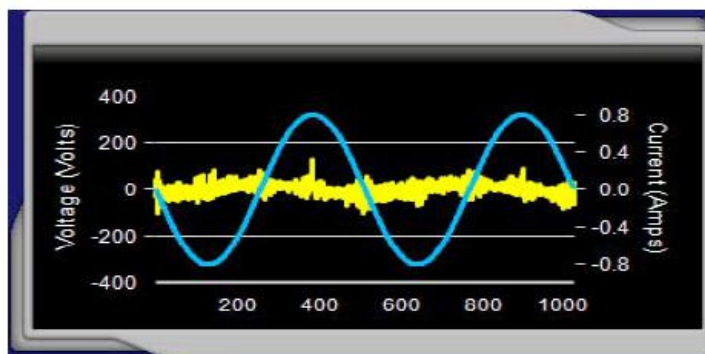



**Current Harmonics (values at the end of test)**

Harm No.	Harm. Ave.	Harm. Limit (100%)	% Of Limits	Result (Ave.)	Result (Max.)	Harm. Win.	Harm. Win. (150%)	% Of Max
2	0.0006	1.0800	0.1	PASS	PASS	0.0009	1.6200	0.1
3	0.0040	2.3000	0.2	PASS	PASS	0.0043	3.4500	0.1
4	0.0006	0.4300	0.1	PASS	PASS	0.0009	0.6450	0.1
5	0.0037	1.1400	0.3	PASS	PASS	0.0040	1.7100	0.2
6	0.0006	0.3000	0.2	PASS	PASS	0.0009	0.4500	0.2
7	0.0038	0.7700	0.5	PASS	PASS	0.0041	1.1550	0.4
8	0.0006	0.2300	0.3	PASS	PASS	0.0009	0.3450	0.3
9	0.0037	0.4000	0.9	PASS	PASS	0.0040	0.6000	0.7
10	0.0006	0.1840	0.3	PASS	PASS	0.0008	0.2760	0.3
11	0.0036	0.3300	1.1	PASS	PASS	0.0040	0.4950	0.8
12	0.0006	0.1530	0.4	PASS	PASS	0.0008	0.2295	0.4
13	0.0035	0.2100	1.7	PASS	PASS	0.0038	0.3150	1.2
14	0.0007	0.1310	0.5	PASS	PASS	0.0010	0.1965	0.5
15	0.0035	0.1500	2.3	PASS	PASS	0.0039	0.2250	1.7
16	0.0006	0.1150	0.5	PASS	PASS	0.0009	0.1725	0.5
17	0.0034	0.1320	2.6	PASS	PASS	0.0038	0.1980	1.9
18	0.0007	0.1020	0.6	PASS	PASS	0.0009	0.1530	0.6
19	0.0033	0.1180	2.8	PASS	PASS	0.0038	0.1770	2.2
20	0.0006	0.0920	0.6	PASS	PASS	0.0009	0.1380	0.6
21	0.0031	0.1070	2.9	PASS	PASS	0.0035	0.1605	2.2
22	0.0007	0.0830	0.8	PASS	PASS	0.0009	0.1245	0.7
23	0.0030	0.0970	3.1	PASS	PASS	0.0034	0.1455	2.3
24	0.0006	0.0760	0.8	PASS	PASS	0.0009	0.1140	0.8
25	0.0028	0.0900	3.1	PASS	PASS	0.0031	0.1350	2.3
26	0.0007	0.0700	0.9	PASS	PASS	0.0009	0.1050	0.9
27	0.0027	0.0830	3.2	PASS	PASS	0.0031	0.1245	2.5
28	0.0006	0.0650	1.0	PASS	PASS	0.0009	0.0975	0.9
29	0.0025	0.0770	3.3	PASS	PASS	0.0029	0.1155	2.5
30	0.0007	0.0610	1.1	PASS	PASS	0.0009	0.0915	1.0
31	0.0024	0.0720	3.4	PASS	PASS	0.0027	0.1080	2.5
32	0.0006	0.0570	1.1	PASS	PASS	0.0010	0.0855	1.2
33	0.0023	0.0680	3.3	PASS	PASS	0.0026	0.1020	2.6
34	0.0007	0.0540	1.2	PASS	PASS	0.0011	0.0810	1.4
35	0.0021	0.0640	3.3	PASS	PASS	0.0024	0.0960	2.5
36	0.0006	0.0510	1.2	PASS	PASS	0.0010	0.0765	1.3
37	0.0020	0.0600	3.3	PASS	PASS	0.0023	0.0900	2.6
38	0.0006	0.0480	1.4	PASS	PASS	0.0009	0.0720	1.2
39	0.0018	0.0570	3.2	PASS	PASS	0.0022	0.0855	2.6
40	0.0006	0.0460	1.4	PASS	PASS	0.0009	0.0690	1.3

**Power Source Verification Data**

Harm No.	Harm. Value	Harm. Limit	% Of Limits	% Of Vfund	Result
2	0.035	0.460	7.615	0.015	OK
3	0.123	2.070	5.949	0.054	OK
4	0.020	0.460	4.388	0.009	OK
5	0.068	0.920	7.369	0.030	OK
6	0.024	0.460	5.291	0.011	OK
7	0.034	0.690	4.967	0.015	OK
8	0.048	0.460	10.441	0.021	OK
9	0.026	0.460	5.558	0.011	OK
10	0.031	0.460	6.807	0.014	OK
11	0.028	0.230	12.375	0.012	OK
12	0.029	0.230	12.687	0.013	OK
13	0.016	0.230	6.841	0.007	OK
14	0.035	0.230	15.040	0.015	OK
15	0.016	0.230	6.802	0.007	OK
16	0.015	0.230	6.358	0.006	OK
17	0.016	0.230	7.078	0.007	OK
18	0.015	0.230	6.570	0.007	OK
19	0.019	0.230	8.123	0.008	OK
20	0.023	0.230	10.075	0.010	OK
21	0.017	0.230	7.574	0.008	OK
22	0.019	0.230	8.210	0.008	OK
23	0.017	0.230	7.561	0.008	OK
24	0.018	0.230	7.786	0.008	OK
25	0.020	0.230	8.650	0.009	OK
26	0.014	0.230	6.265	0.006	OK
27	0.015	0.230	6.468	0.006	OK
28	0.014	0.230	6.188	0.006	OK
29	0.016	0.230	7.057	0.007	OK
30	0.018	0.230	7.824	0.008	OK
31	0.018	0.230	7.686	0.008	OK
32	0.021	0.230	9.163	0.009	OK
33	0.016	0.230	6.784	0.007	OK
34	0.021	0.230	9.074	0.009	OK
35	0.017	0.230	7.422	0.007	OK
36	0.021	0.230	9.071	0.009	OK
37	0.019	0.230	8.228	0.008	OK
38	0.020	0.230	8.588	0.009	OK
39	0.016	0.230	6.920	0.007	OK
40	0.015	0.230	6.379	0.006	OK

## 9. VOLTAGE FLUCTUATION AND FLICKER MEASUREMENT

### 9.1. Block Diagram of Test Setup

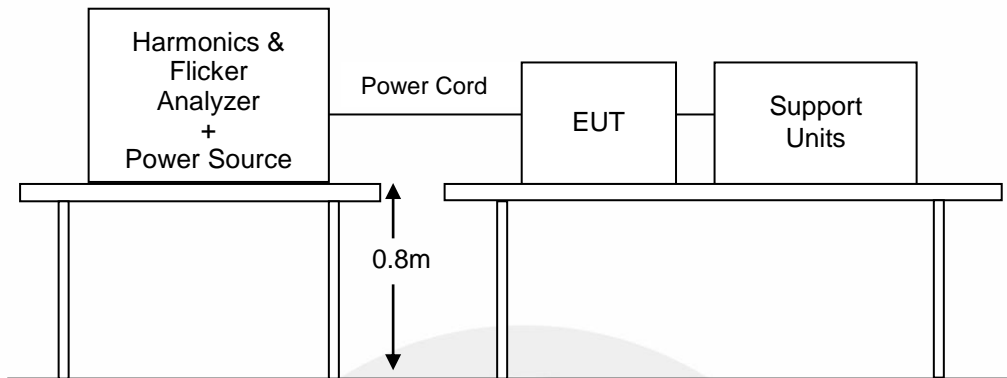

### 9.2. Standard Limits

#### BS EN 61000-3-3 Limits

The objective of voltage changes, voltage fluctuations and flicker in public low voltage supply systems during equipment with rated current  $\leq 16$  A per phase, ensures that home appliances and certain other electrical equipment do not adversely affect lighting equipment when connected to the same power system.

#### Voltage Fluctuation and Flicker Limits:

- the value of  $P_{st}$  shall not be greater than 1.0;
- the value of  $Plt$  shall not be greater than 0.65;
- the value of  $d(t)$  during a voltage change shall not exceed 3.3 % for more than 500 ms;
- the relative steady-state voltage change,  $dc$ , shall not exceed 3.3 %;
- the maximum relative voltage change,  $d_{max}$ , shall not exceed 4.0 %;

### 9.3. Test Procedure

The total impedance of the test circuit, excluding the appliance under test, but including the internal impedance of the supply source, shall be equal to the reference impedance. The stability and tolerance of the reference impedance shall be adequate to ensure that the overall accuracy of 8% is achieved during the whole assessment procedure.

### 9.4. Test Results

**Pass.**

Please refer to the following pages.

<b>EUT:</b>	<b>Adapter Box (Adapter Box G2)</b>
<b>Test Standard:</b>	<b>Test per IEC 61000-3-3 Ed. 3.1 : 2017</b>
<b>Test Class:</b>	<b>Flicker Test, Pst-dc-dmax-Tmax</b>
<b>Test Result:</b>	<b>PASS</b>
<b>Test Date:</b>	<b>2022/11/30</b>
<b>Start Time:</b>	<b>13:35:25</b>
<b>Stop Time:</b>	<b>13:45:48</b>
<b>Test Duration (min):</b>	<b>10</b>
<b>Environment:</b>	<b>Temp: 25°C; Humi:45%</b>
<b>Source Qualification:</b>	<b>Compliance with IEC 61000-3-3 Ed. 3.1 : 2017</b>
<b>Customer:</b>	<b>Customer</b>
<b>Test By:</b>	<b>Jo Liu</b>
<b>Comments:</b>	<b>ON</b>

### Phase A

<b>Vrms (Volts):</b>	<b>229.39</b>	<b>Frequency (Hz):</b>	<b>50.00</b>
<b>I<sub>rms</sub> (Amps):</b>	<b>0.042</b>	<b>Power (W):</b>	<b>0.9</b>
<b>V-THD (%):</b>	<b>0.067</b>	<b>T-Max (ms):</b>	<b>0 (500)</b>
<b>dmax (%):</b>	<b>0.000 (4.000)</b>	<b>Hi dmax (%):</b>	<b>0.000 (4.000)</b>
<b>dc (%):</b>	<b>0.000 (3.300)</b>	<b>Hi dc (%):</b>	<b>0.000 (3.300)</b>
<b>Pst-1 :</b>	<b>0.039 (1.000)</b>		
<b>Plt :</b>	<b>0.017 (0.650)</b>		

### Pst Spectrum

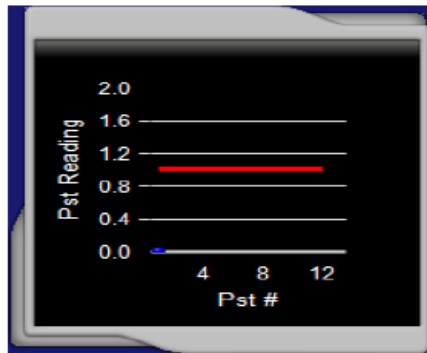

### Plt Spectrum

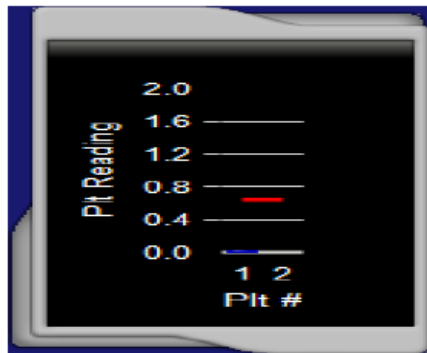

## 10. IMMUNITY GENERAL PERFORMANCE CRITERIA DESCRIPTION

General performance criteria are defined in BS EN 55035 clause 8.2, 8.3 and 8.4. These criteria shall be used during the testing of primary functions where no relevant annex is applicable.

When assessing the impact of a disturbance on a function, the assessment should take into consideration the function's performance prior to the application of the disturbance and only identify as failures those changes in performance that are a result of the disturbance.

BS EN 55035:

Performance criterion A

The equipment shall continue to operate as intended without operator intervention. No degradation of performance, loss of function or change of operating state is allowed below a performance level specified by the manufacturer when the equipment is used as intended. The performance level may be replaced by a permissible loss of performance. If the minimum performance level or the permissible performance loss is not specified by the manufacturer, then either of these may be derived from the product description and documentation, and by what the user may reasonably expect from the equipment if used as intended.

Performance criterion B

During the application of the disturbance, degradation of performance is allowed. However, no unintended change of actual operating state or stored data is allowed to persist after the test.

After the test, the equipment shall continue to operate as intended without operator intervention; no degradation of performance or loss of function is allowed, below a performance level specified by the manufacturer, when the equipment is used as intended. The performance level may be replaced by a permissible loss of performance.

If the minimum performance level (or the permissible performance loss), or recovery time, is not specified by the manufacturer, then either of these may be derived from the product description and documentation, and by what the user may reasonably expect from the equipment if used as intended.

Performance criterion C

Loss of function is allowed, provided the function is self-recoverable, or can be restored by the operation of the controls by the user in accordance with the manufacturer's instructions. A reboot or re-start operation is allowed. Information stored in non-volatile memory, or protected by a battery backup, shall not be lost.

## 11. ELECTROSTATIC DISCHARGE

### 11.1. Test Specification

Test standard	: BS EN 55035
Basic standard	: IEC 61000-4-2
Performance criterion	: B
Test level	: ±8.0kV (Air discharge) ±4.0kV (Contact discharge)

### 11.2. Block Diagram of Test Setup

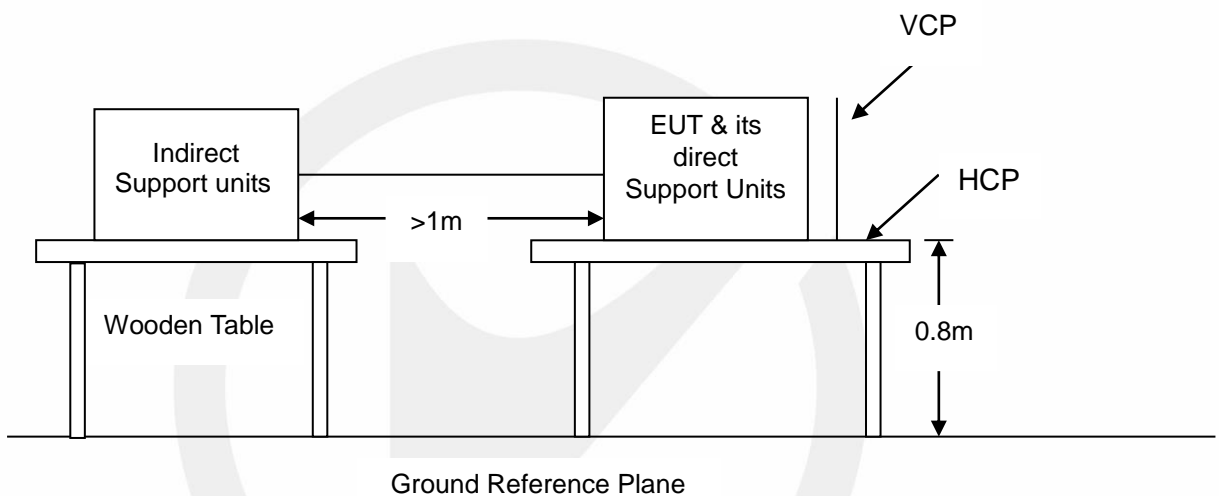

### 11.3. Test Procedure

- In the case of air discharge testing, the climatic conditions shall be within the following ranges:
  - ambient temperature: 15°C to 35°C;
  - relative humidity : 30% to 60%;
  - atmospheric pressure : 86 kPa (860 mbar) to 106 kPa (1060 mbar)
- Test programs and software shall be chosen so as to exercise all normal modes of operation of the EUT. The use of special exercising software is encouraged, but permitted only where it can be shown that the EUT is being comprehensively exercised.
- In the case of contact discharges, the tip of the discharge electrode shall touch the EUT before the discharge switch is operated.
- In the case of painted surface covering a conducting substrate, the following procedure shall be adopted :
  - If the coating is not declared to be an insulating coating by the equipment manufacturer, then the pointed tip of the generator shall penetrate the coating so as to make contact with the conducting substrate.
  - Coating declared as insulating by the manufacturer shall only be submitted to the air discharge.
  - The contact discharge test shall not be applied to such surfaces.
- In the case of air discharges, the round discharge tip of the discharge electrode shall be approached as fast as possible (without causing mechanical damage) to touch the EUT. After each discharge, the ESD generator (discharge electrode) shall be removed from the EUT. The generator is then retriggered for a new single discharge. This procedure shall be repeated until the discharges are completed. In the case of an air discharge test, the discharge switch, which is used for contact discharge, shall be closed.

- f. The test voltage shall be increased from the minimum to the selected test severity level, in order to determine any threshold of failure. The final test level should not exceed the product specification value in order to avoid damage to the equipment.
- g. The test shall be performed with both air discharge and contact discharge. The test shall be performed with single discharges. On each pre-selected point at least 10 single discharges (in the most sensitive polarity) shall be applied. For the time interval between successive single discharges an initial value of 1 s is recommended. Longer intervals may be necessary to determine whether a system failure has occurred.
- h. Ensure that the applied charge on the EUT has been dis-charged before next ESD pulse.

### 11.4. Test Results

**Pass.**

Temperature : 23 °C  
 Humidity : 53 %  
 Atmospheric Pressure : 101kpa  
 Test Engineer : Ace Li  
 Test Date : 2022-12-01

**Air Discharge:**

Test Voltage	Location	Actual criterion	Required performance criterion	Result (Pass/Fail)
±2; 4; 8 kV	All slots of the EUT	A	B	Pass
±2; 4; 8 kV	Non-Conducted Enclosure	A	B	Pass

**Contact Discharge**

Test Voltage	Location	Actual criterion	Required performance criterion	Result (Pass/Fail)
±2; 4kV	/	/	B	/
±2; 4kV	/	/	B	/

**Indirect Discharge**

Test Voltage	Location	Actual criterion	Required performance criterion	Result (Pass/Fail)
±2; 4 kV	HCP	A	B	Pass
±2; 4kV	VCP	A	B	Pass

## 12. CONTINUOUS RF ELECTROMAGNETIC FIELD DISTURBANCES

### 12.1. Test Specification

Test standard	: BS EN 55035	
Basic standard	: IEC 61000-4-3	
Performance criterion	: A	
Frequency range &	: <input checked="" type="checkbox"/> 80M-1000MHz	3V/m
Test level	: <input checked="" type="checkbox"/> Spot frequency	3V/m
	: <input type="checkbox"/> Additional spot frequency	3V/m
Modulation	: AM, 80%, 1kHz sine-wave	

### 12.2. Block Diagram of Test Setup

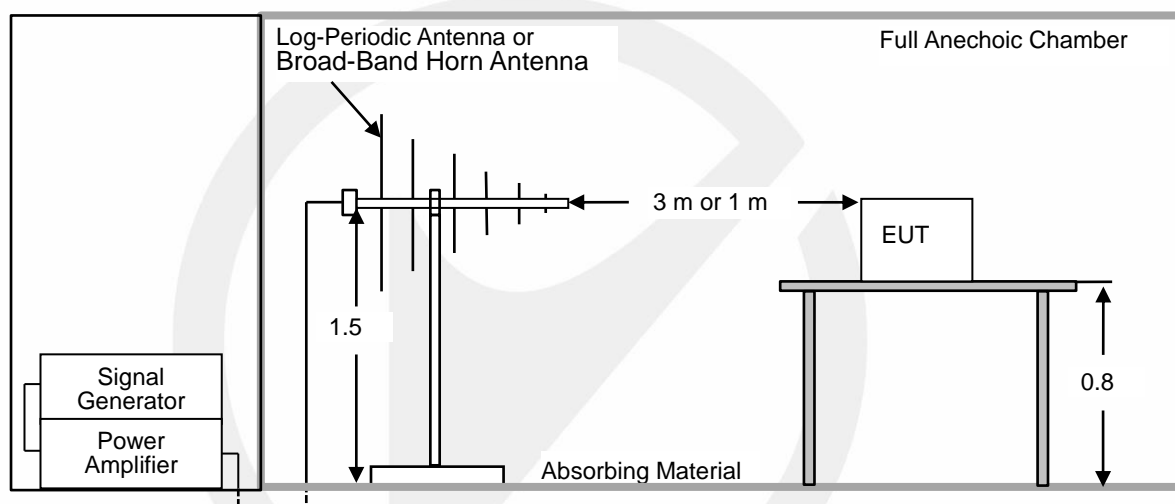

### 12.3. Test procedure

The procedure defined in this part requires the generation of electromagnetic fields within which the test sample is placed and its operation observed. To generate fields that are useful for simulation of actual (field) conditions may require significant antenna drive power and the resultant high field strength levels. To comply with local regulations and to prevent biological hazards to the testing personnel, it is recommended that these tests be carried out in a shielded enclosure or semi-anechoic chamber.

- a. The antenna which is enabling the complete frequency range of 80-1000 MHz is placed 3m (or 1m) away from the equipment. The required field strength is determined by placing the field strength meter(s) on top of or directly alongside the equipment under test and monitoring the field strength meter via a remote field strength indicator outside the enclosure while adjusting the continuous-wave to the antenna.
- b. The test is performed with the antenna facing the front and back sides of the EUT with. Both vertical and horizontal polarizations from antenna are tested.



### 12.4. Test results

**Pass.**

Temperature : 24°C  
 Humidity : 48 %  
 Atmospheric Pressure : 101kpa  
 Test Engineer : Lucas Xu  
 Test Date : 2022-12-01

80M-1000MHz:

Freq. Range (MHz)	Field	Modulation	Polarity	Position (°)	Actual criterion	Required performance criterion	Result
80-1000	3V/m	AM, 80%	H / V	0, 90,180, 270	A	A	Pass

Spot frequency:

Freq (MHz)	Field	Modulation	Polarity	Position (°)	Actual criterion	Required performance criterion	Result
1800, 2600, 3500, 5000	3V/m	AM, 80%	H / V	0, 90,180, 270	A	A	Pass

Additional spot frequency:

Freq (MHz)	Field	Modulation	Polarity	Position (°)	Actual criterion	Required performance criterion	Result
80, 120, 160, 230, 434, 460, 600, 863, 900	3V/m	AM, 80%	H / V	0, 90,180, 270	N/A	A	N/A

### 13. ELECTRICAL FAST TRANSIENTS/BURST

#### 13.1. Test Specification

Test standard	: BS EN 55035
Basic standard	: IEC 61000-4-4
Performance criterion	: B
Test level	: <input checked="" type="checkbox"/> 1kV, AC mains power ports <input type="checkbox"/> 0.5kV, DC network power ports <input checked="" type="checkbox"/> 0.5kV, Analogue/digital data ports
Repetition frequency	: <input checked="" type="checkbox"/> 5kHz, <input type="checkbox"/> 100kHz(Only xDSL ports)
Tr/Th:	: 5/50ns
Burst period	: 300ms
Test time :	: 120s

#### 13.2. Block Diagram of Test Setup

AC Lines:

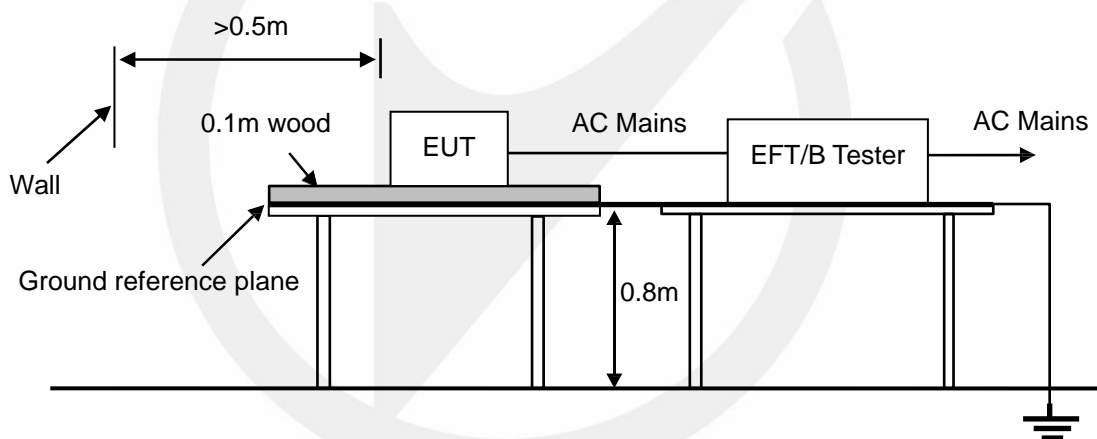

Signal lines:

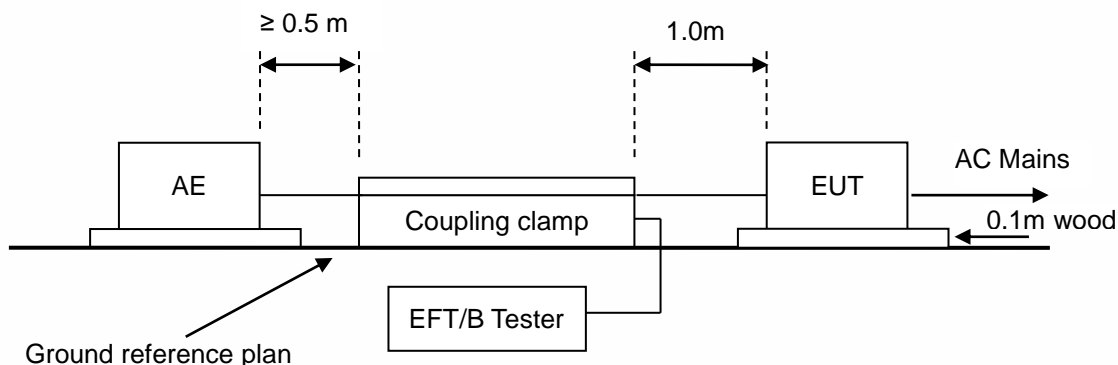

### 13.3. Test Procedure

The EUT is put on the table that is 0.8 meter high above the ground. This reference ground plane shall project beyond the EUT by at least 0.1m on all sides and the minimum distance between EUT and all other conductive structure, except the ground plane beneath the EUT, shall be more than 0.5m.

### 13.4. Test Results

**Pass.**

Temperature : 25 °C  
 Humidity : 45 %  
 Atmospheric Pressure : 101kpa  
 Test Engineer : Ace Li  
 Test Date : 2022-12-01

Injection Line	Voltage (kV)	Injected Method	Actual criterion	Required performance criterion	Result (Pass/Fail)
<input checked="" type="checkbox"/> AC mains power ports	± 1	<input type="checkbox"/> CDN <input checked="" type="checkbox"/> Direct injection <input type="checkbox"/> Capacitive coupling clamp	A	B	Pass
<input type="checkbox"/> DC network power ports	± 0.5	<input type="checkbox"/> CDN <input type="checkbox"/> Direct injection <input type="checkbox"/> Capacitive coupling clamp	N/A	B	N/A
<input checked="" type="checkbox"/> Analogue/digital data ports (Wired network port)	± 0.5	<input type="checkbox"/> CDN <input type="checkbox"/> Direct injection <input checked="" type="checkbox"/> Capacitive coupling clamp	A	B	Pass
<input type="checkbox"/> Analogue/digital data ports (Broadcast receiver tuner port)	± 0.5	<input type="checkbox"/> CDN <input type="checkbox"/> Direct injection <input type="checkbox"/> Capacitive coupling clamp	N/A	B	N/A
<input type="checkbox"/> Analogue/digital data ports (.....)	± 0.5	<input type="checkbox"/> CDN <input type="checkbox"/> Direct injection <input type="checkbox"/> Capacitive coupling clamp	N/A	B	N/A

## 14. SURGES

### 14.1. Test Specification

Test standard	:	BS EN 55035
Basic standard	:	IEC 61000-4-5
Test level	:	<input checked="" type="checkbox"/> 1kV, Line to Line, AC mains power ports, Criterion B <input type="checkbox"/> 2kV, Line to Earth, AC mains power ports, Criterion B <input type="checkbox"/> 0.5kV, Line to Reference ground, DC network power ports, Criterion B <input type="checkbox"/> 1.0kV, 4.0kV, Lines to Ground, Unshielded symmetrical, where primary protection is intended, Criterion C <input checked="" type="checkbox"/> 1.0kV, Lines to Ground, Unshielded symmetrical, where primary protection is not intended Criterion C <input type="checkbox"/> 0.5kV, Shield to ground, Coaxial or shielded port, Criterion B
Number of surges	:	5 (for each combination of parameters)
Repetition rate	:	1 minute / time
Polarity:	:	Positive / Negative
Phase angle:	:	90°, 270° (Only AC mains power ports)

### 14.2. Block Diagram of Test Setup

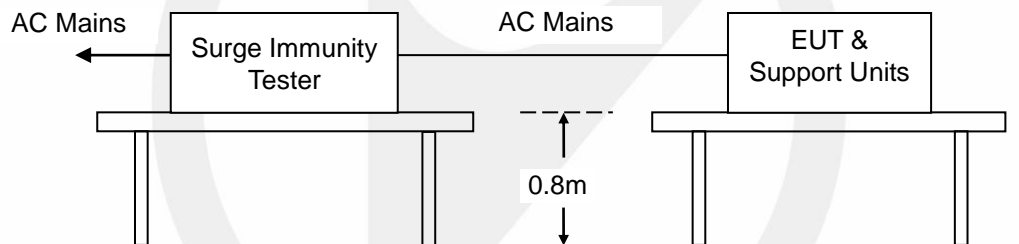

### 14.3. Test Procedure

This test simulates a lightning event by inducing transients onto the AC/DC power supply lines in common mode (Line to Ground) and differential mode (Line to Line). Each device was tested in a total of two surge configurations: Line to Ground (L-G): Combination Wave, Line to Protective Earth with 9uF and 10Ohm and Neutral to Protective Earth with 9uF and 10Ohm, common mode, generator earthed.

Line to Line (L-L): Combination Wave,

Line to Neutral with 18uF, differential mode, generator floated.

2 ohm : the source impedance of the low-voltage power supply network.

12 ohm : the source impedance of the low-voltage power supply network and ground.

- If not otherwise specified the surges have to be applied synchronized to the voltage phase at the zero-crossing and the peak value of the a.c. voltage wave (positive and negative).
- The surges have to be applied line to line and line to earth. When testing line to earth, the test voltage has to be applied successively between each of the lines and earth, if there is no other specification.
- The test procedure shall also consider the non-linear current-voltage characteristics of the equipment under test. Therefore the test voltage has to be increased by steps up to the test level specified in the product standard or test plan. All lower levels including the selected test level shall be satisfied.
- For testing the secondary protection, the output voltage of the generator shall be increased up to the worst-case voltage breakdown level (let-through level) of the primary protection.
- Testing shall be performed according to a Test Plan, which shall be included in the test report.
- To find all critical points of the duty cycle of the equipment, a sufficient number of positive and negative test pulses shall be applied.

## 14.4. Test results

### Pass.

Temperature : 25 °C  
 Humidity : 45 %  
 Atmospheric Pressure : 101kpa  
 Test Engineer : Ace Li  
 Test Date : 2022-12-01

#### AC mains power ports:

Coupling Line	Voltage (kV)	Waveform (μs)	Polarity	Actual criterion	Required performance criterion	Result (Pass/Fail)
<input checked="" type="checkbox"/> Line to line	1	1.2/50 (8/20)	Pos./ Neg.	A	B	Pass
<input type="checkbox"/> Line to earth	2	1.2/50 (8/20)	Pos./ Neg.	N/A	B	N/A

#### DC network power ports:

Coupling Line	Voltage (kV)	Waveform (μs)	Polarity	Actual criterion	Required performance criterion	Result (Pass/Fail)
Line to Reference ground	0.5	1.2/50 (8/20)	Pos./ Neg.	N/A	B	N/A

#### Analogue/digital data ports:

Port type	Coupling Line	Voltage (kV)	Waveform (μs)	Polarity	Actual criterion	Required performance criterion	Result (Pass/Fail)
<input checked="" type="checkbox"/> Unshielded symmetrical (Wired network port)	Lines to ground	0.5, 1	10/700 (5/320)	Pos./ Neg.	A	C	Pass
<input type="checkbox"/> Unshielded symmetrical (.....)	Lines to ground	0.5, 1	10/700 (5/320)	Pos./ Neg.	N/A	C	N/A
<input type="checkbox"/> Unshielded symmetrical	Lines to ground	0.5, 1, 2, 4	10/700 (5/320)	Pos./ Neg.	N/A	C	N/A
<input type="checkbox"/> Coaxial or shielded (Broadcast receiver tuner port)	Shield to ground	0.5	1.2/50 (8/20)	Pos./ Neg.	N/A	B	N/A
<input type="checkbox"/> Coaxial or shielded (.....)	Shield to ground	0.5	1.2/50 (8/20)	Pos./ Neg.	N/A	B	N/A

## 15. CONTINUOUS INDUCED RF DISTURBANCES

### 15.1. Test Specification

Test standard	: BS EN 55035
Basic standard	: IEC 61000-4-6
Performance criterion	: A
Frequency range &	: 0.15M to 10MHz, 3V
Test level	: 10M to 30MHz, 3V to 1V 30M to 80MHz, 1V
Modulation	: AM 80%, 1kHz sine-wave
Frequency Step	: 1% of fundamental

### 15.2. Block Diagram of Test Setup

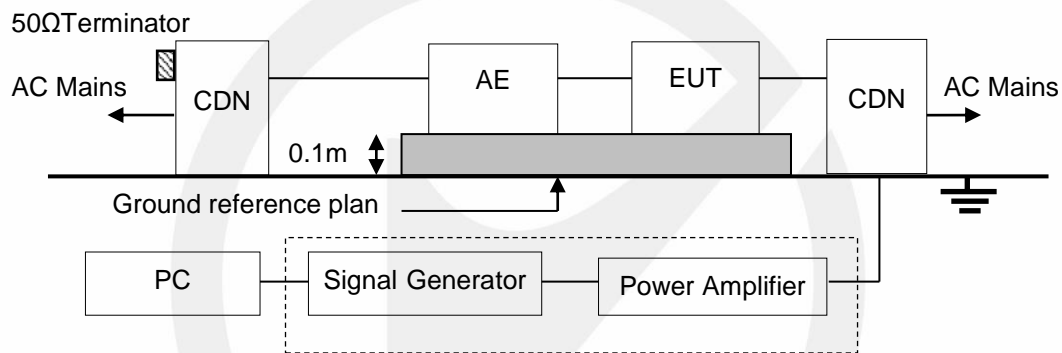

### 15.3. Test Procedure

- The EUT shall be operated within its intended climatic conditions. The temperature and relative humidity should be recorded.
- The EUT is placed on a 0.1m high test table, and a well grounded cable is connected to metallic plane above the test table.
- All cables/wires must be laid out on test plate (3cm in thickness), and the EUT is set up on test plate (10 cm in thickness) as shown in test setup photo, and the cables/wires must not be in mid-air, they should be touching the surface of test plate. Ensure that the EUT is properly connected to the accessory equipment.
- The test shall be performed with the test generator connected to each of the coupling and decoupling devices in turn while the other non-excited RF-input ports of the coupling devices are terminated by a 50 ohm load resistor.
- The frequency range is swept from 150 kHz to 80 MHz, using the signal levels established during the setting process, and with the disturbance signal 80% amplitude modulated with a 1 kHz sine wave, pausing to adjust the RF-signal level or to switch coupling devices as necessary. The rate of sweep shall no exceed  $1.5 \times 10^{-3}$  decades/s. Where the frequency is swept incrementally, the step size shall no exceed 1% of the start and thereafter 1% of the preceding frequency value.
- The dwell time at each frequency shall not be less than the time necessary for the EUT to be exercised, and able to respond. Sensitive frequencies e.g. clock frequency (ies) and harmonics or frequencies of dominant interest shall be analyzed separately.
- Attempts should be made to fully exercise the EUT during testing, and to fully interrogate all exercise modes selected for susceptibility
- Testing shall be performed according to a Test Plan, which shall be included in the test report.

### 15.4. Test results

**Pass.**

Temperature : 25 °C  
 Humidity : 45 %  
 Atmospheric Pressure : 101kpa  
 Test Engineer : Ace Li  
 Test Date : 2022-12-01

Range (MHz)	Levers (V)	Injection port	Coupling type	Actual criterion	Required performance criterion	Result (Pass/Fail)
0.15-10	3	<input checked="" type="checkbox"/> AC mains power ports	<input checked="" type="checkbox"/> CDN	A	A	Pass
10-30	3-1		<input type="checkbox"/> EM Clamp			
30-80	1		<input type="checkbox"/> Current Clamp <input type="checkbox"/> Direct injection			
0.15-10	3	<input type="checkbox"/> DC network power ports	<input type="checkbox"/> CDN	N/A	A	N/A
10-30	3-1		<input type="checkbox"/> EM Clamp			
30-80	1		<input type="checkbox"/> Current Clamp <input type="checkbox"/> Direct injection			
0.15-10	3	<input checked="" type="checkbox"/> Analogue/digital data ports (Wired network port)	<input type="checkbox"/> CDN	A	A	Pass
10-30	3-1		<input type="checkbox"/> EM Clamp			
30-80	1		<input checked="" type="checkbox"/> Current Clamp <input type="checkbox"/> Direct injection			
0.15-10	3	<input type="checkbox"/> Analogue/digital data ports (Broadcast receiver tuner port)	<input type="checkbox"/> CDN	N/A	A	N/A
10-30	3-1		<input type="checkbox"/> EM Clamp			
30-80	1		<input type="checkbox"/> Current Clamp <input type="checkbox"/> Direct injection			
0.15-10	3	<input type="checkbox"/> Analogue/digital data ports (.....)	<input type="checkbox"/> CDN	N/A	A	N/A
10-30	3-1		<input type="checkbox"/> EM Clamp			
30-80	1		<input type="checkbox"/> Current Clamp <input type="checkbox"/> Direct injection			

## POWER FREQUENCY MAGNETIC FIELD

### 15.5. Test Specification

Test Standard : BS EN 55035  
 Basic Standard : IEC 61000-4-8  
 Performance criterion : A  
 Test level : 1A/m

### 15.6. Block Diagram of Test Setup

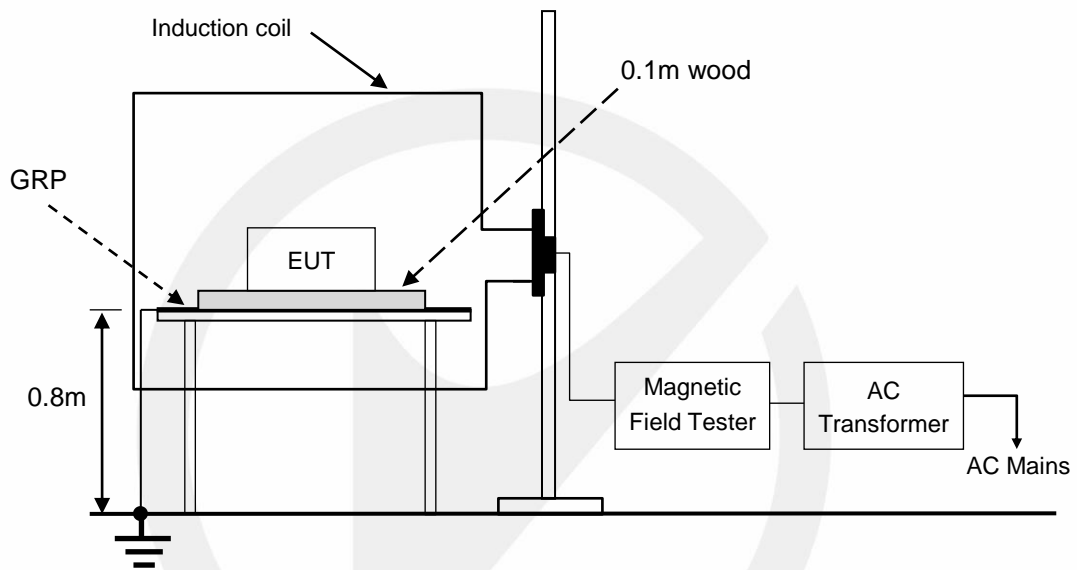

GRP: Ground reference plane  
 EUT: Equipment under test

### 15.7. Test Procedure

The EUT is placed in the middle of a induction coil (1\*1m), under which is a 1\*1\*0.1m (high) table above the GRP, this small table is also placed on a larger table, 0.8 m above the ground. Both horizontal and vertical polarization of the induction coil is set on test, so that each side of the EUT is affected by the magnetic field. Also can reach the same aim by change the position of the EUT.

### 15.8. Test Results

N/A.



## 16. VOLTAGE DIPS AND INTERRUPTIONS

### 16.1. Test Specification

Test standard	:	BS EN 55035
Basic standard	:	IEC 61000-4-11
Test level	:	0%, 0.5 period, Criterion B
		<input checked="" type="checkbox"/> 70%, 25 periods for 50Hz, Criterion C
		<input checked="" type="checkbox"/> 70%, 30 periods for 60Hz, Criterion C
		<input checked="" type="checkbox"/> 0%, 250 periods for 50Hz, Criterion C
		<input checked="" type="checkbox"/> 0%, 300 periods for 60Hz, Criterion C

### 16.2. Block Diagram of Test Setup

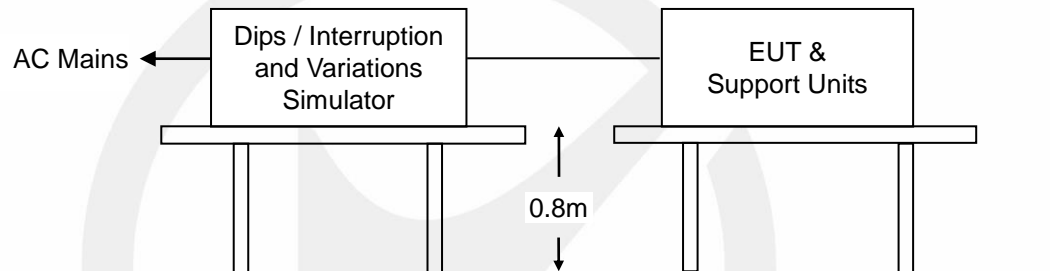

### 16.3. Test Procedure

- a. Where the equipment has a rated voltage the following shall apply - If the voltage range does not exceed 20% of the lower voltage specified for the rated voltage range, a single voltage within that range may be specified as a basis for test level specification.
  - In all other cases, the test procedure shall be applied for both the lowest and highest voltages declared in the voltage range.
- b. Test Conditions
  - Select operated voltage and frequency of EUT - Test of interval : 10 sec.
  - Level and duration : Sequence of 3 dips/interrupts.
  - Voltage rise (and fall) time : 1.5  $\mu$ s.

### 16.4. Test results

**Pass.**

Temperature : 25 °C  
 Humidity : 45 %  
 Atmospheric Pressure : 101kpa  
 Test Engineer : Ace Li  
 Test Date : 2022-12-01

Item	Test Level (% UT)	Phase angle (°)	Input Voltage (V)	Freq (Hz)	Duration (periods)	Actual criterion	Required performance criterion	Result (Pass /Fail)
<input checked="" type="checkbox"/> Voltage dips	0%	0°, 180°	AC 230V	50	0.5	A	B	Pass
<input checked="" type="checkbox"/> Voltage dips	0%	0°, 180°	AC 230V	60	0.5	A	B	Pass
<input checked="" type="checkbox"/> Voltage dips	70%	0°, 180°	AC 230V	50	25	A	C	Pass
<input checked="" type="checkbox"/> Voltage dips	70%	0°, 180°	AC 230V	60	30	A	C	Pass
<input checked="" type="checkbox"/> Voltage interruptions	0%	0°, 180°	AC 230V	50	250	B	C	Pass
<input checked="" type="checkbox"/> Voltage interruptions	0%	0°, 180°	AC 230V	60	300	B	C	Pass

## 17. PHOTOGRAPHS

### 17.1. Photo of Conducted Emission Measurement



17.2.Photo of Conducted Emissions at Telecommunications/network port Measurement



17.3.Photo of Radiation Emission Measurement (Up to 1GHz)

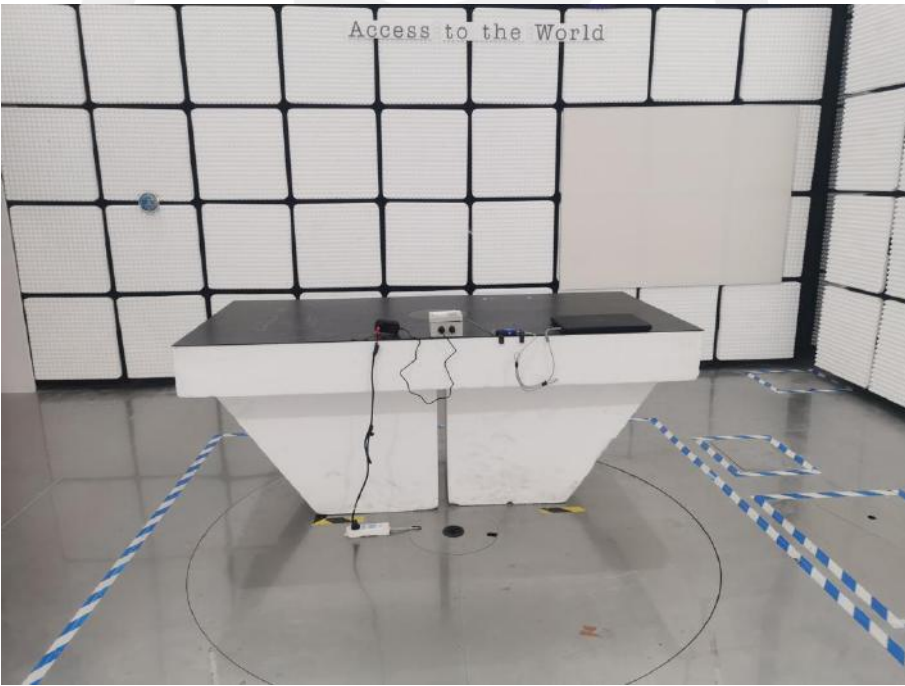
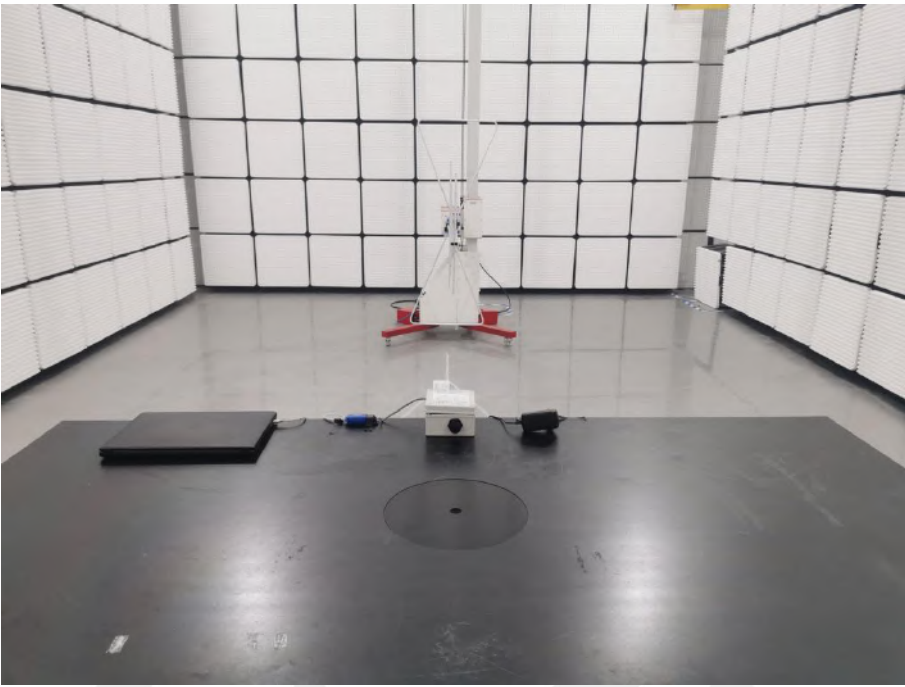

#### 17.4. Photo of Radiation Emission Measurement ( Above 1GHz)

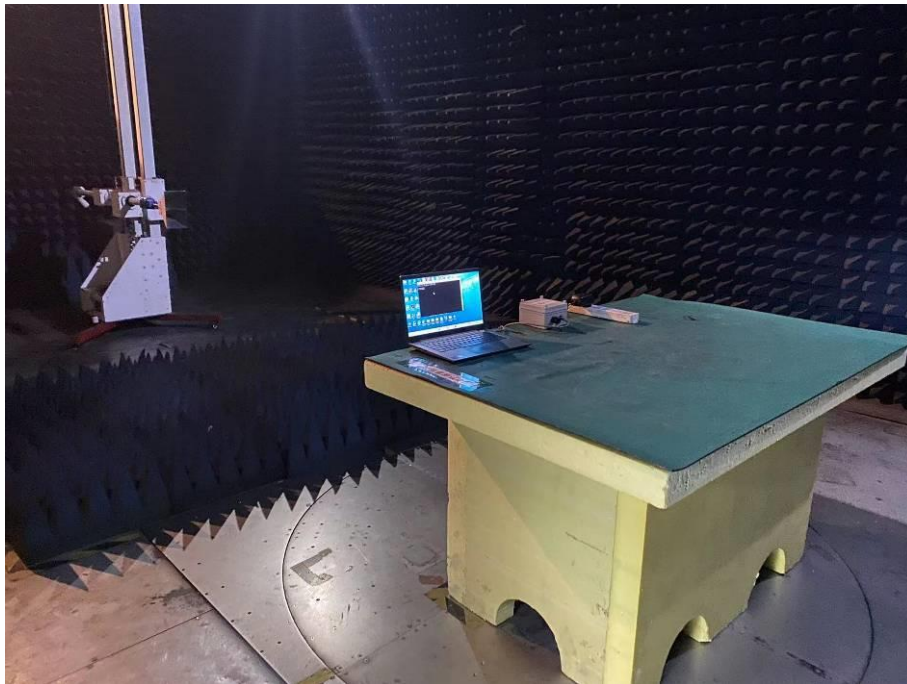

#### 17.5. Photo of Harmonic and Flicker Measurement



### 17.6. Photo of Electrostatic Discharge Test



### 17.7. Photo of RF Field Strength Susceptibility Test

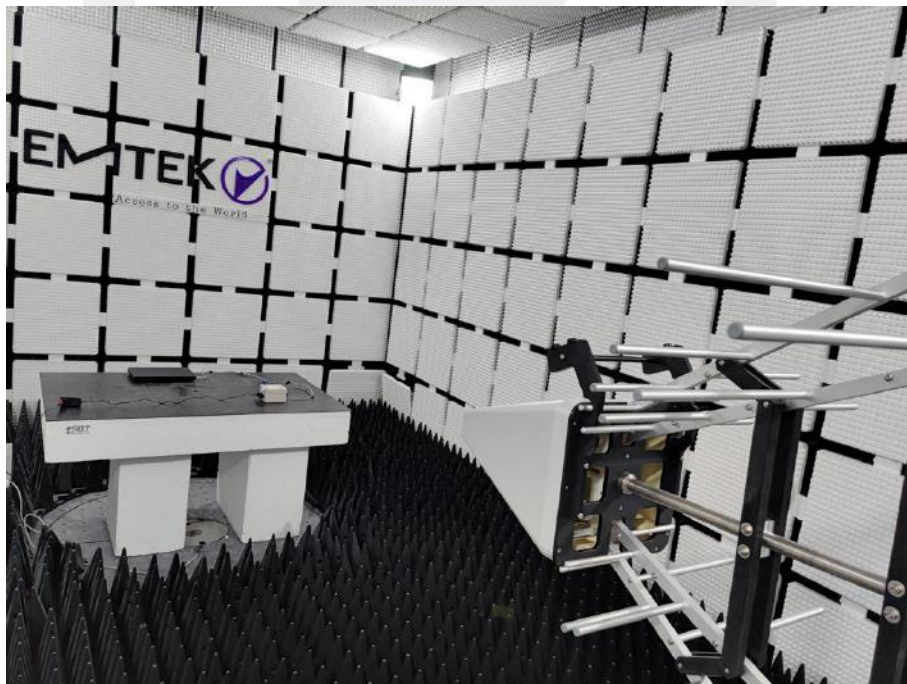

### 17.8.Photo of Electrical Fast Transient /Burst Test



### 17.9.Photo of Surge Test

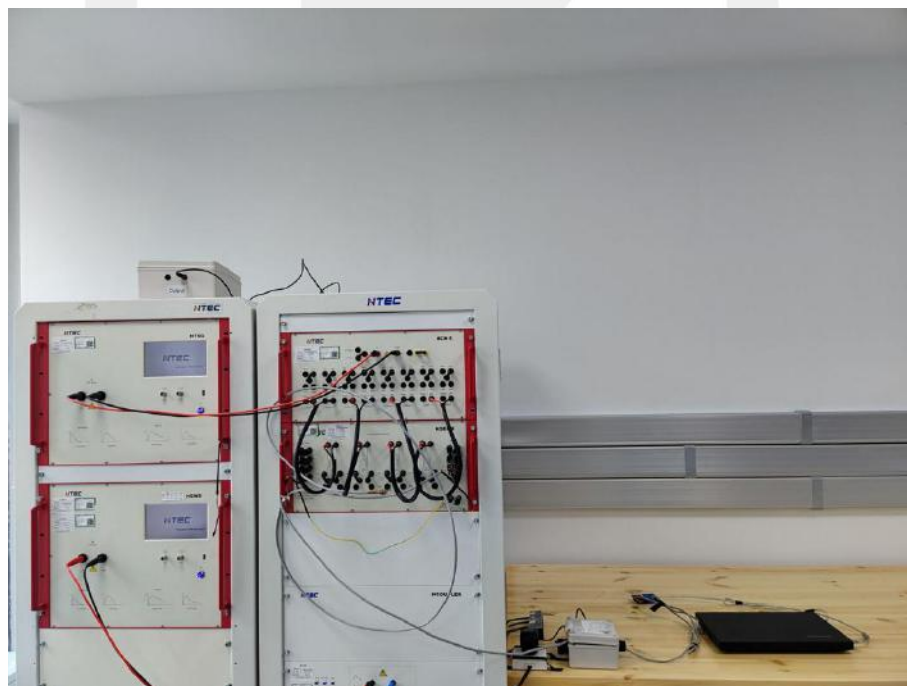



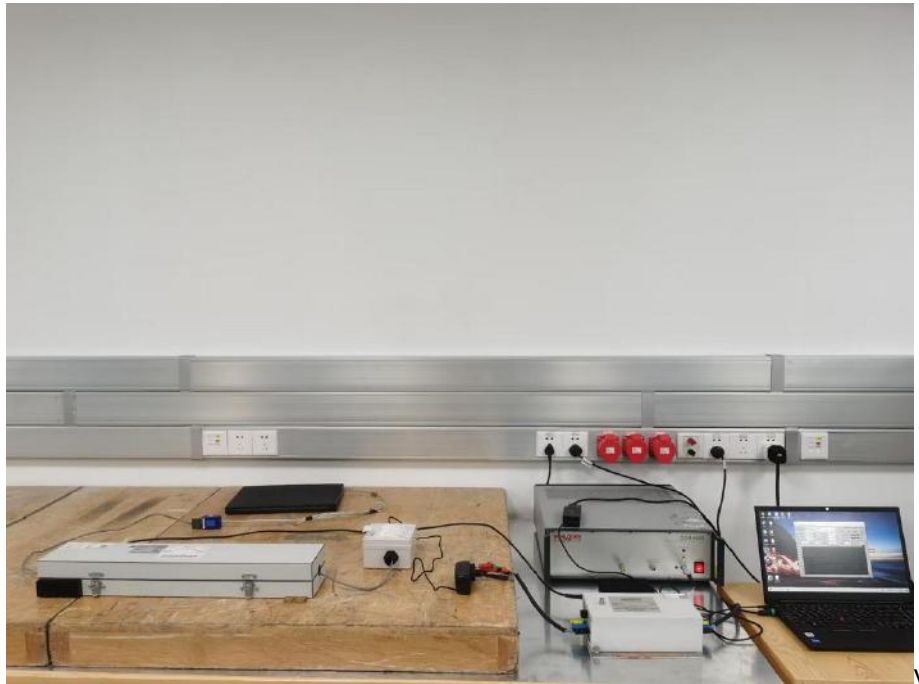

17.10.Photo of Injected Currents Susceptibility Test

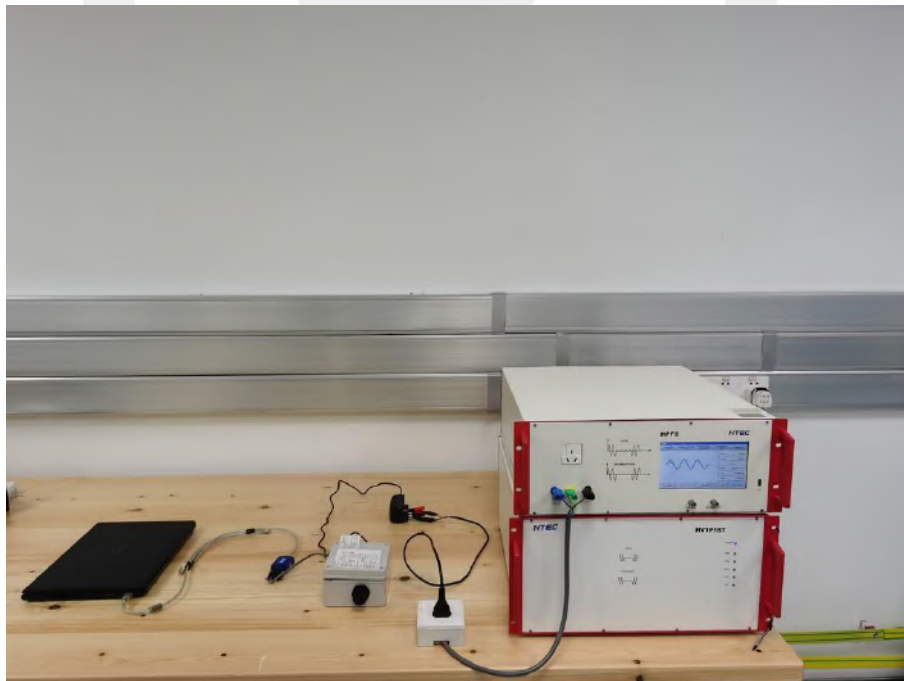

17.11.Photo of Voltage Dips and Interruption Immunity Test





**APPENDIX  
(PHOTOS OF EUT)**



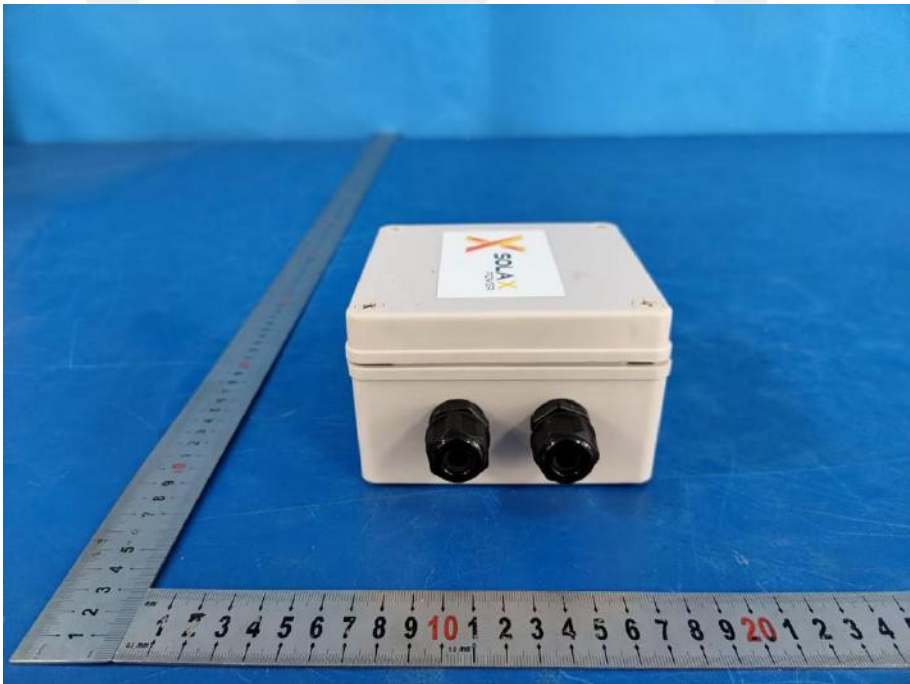
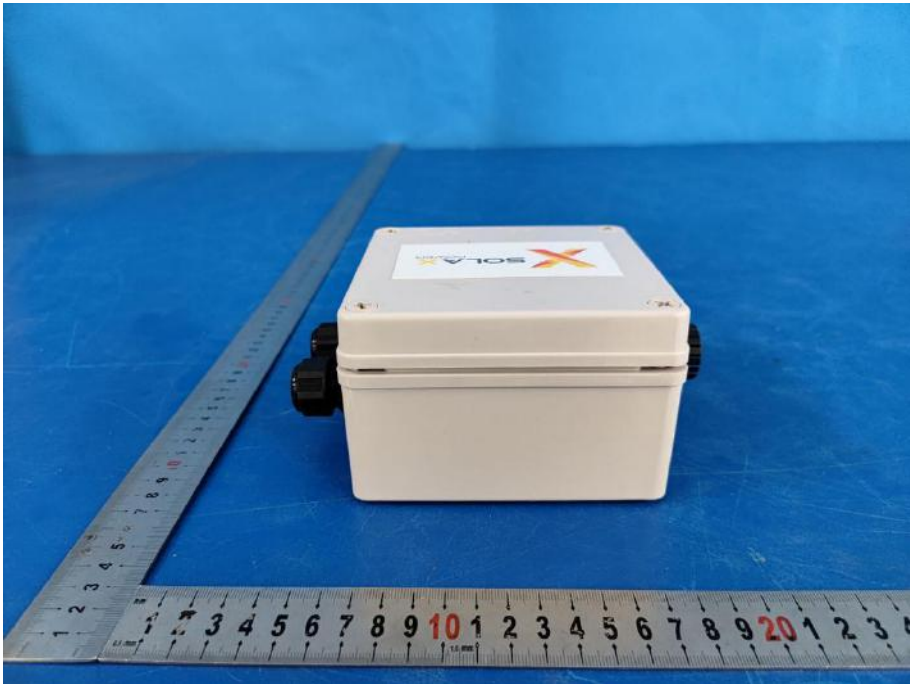

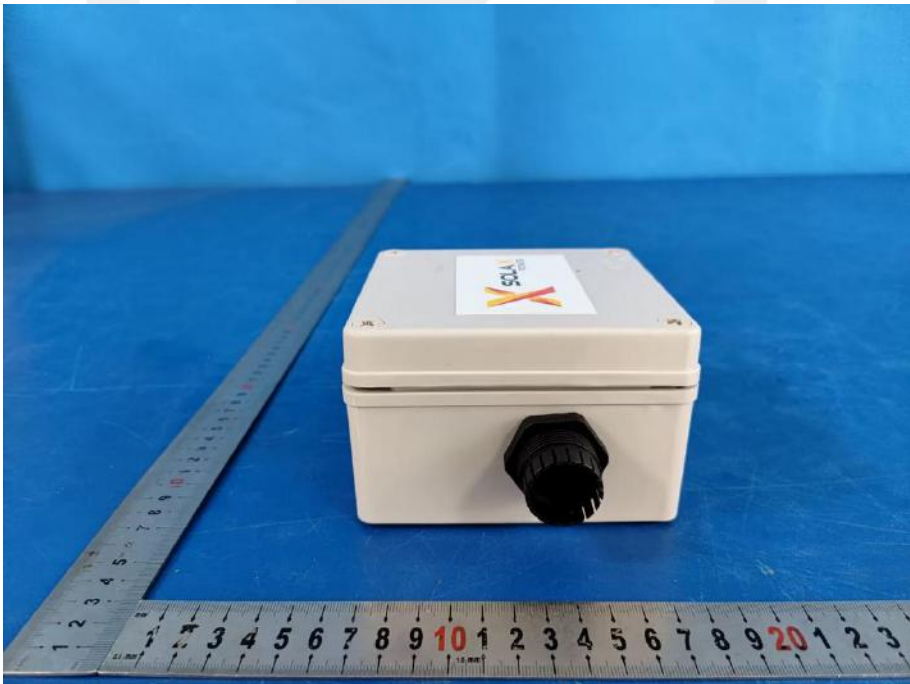
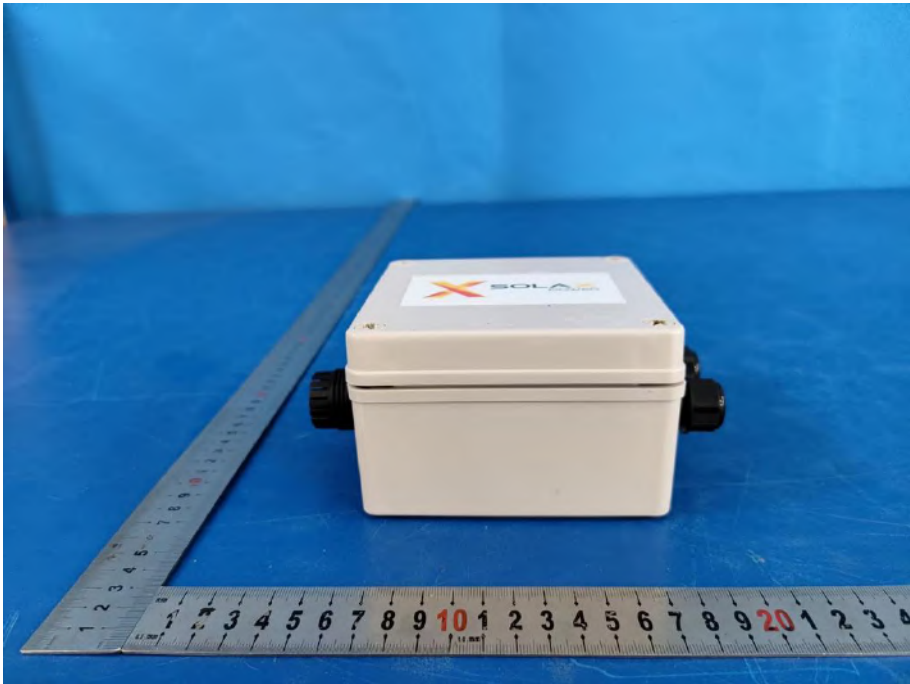

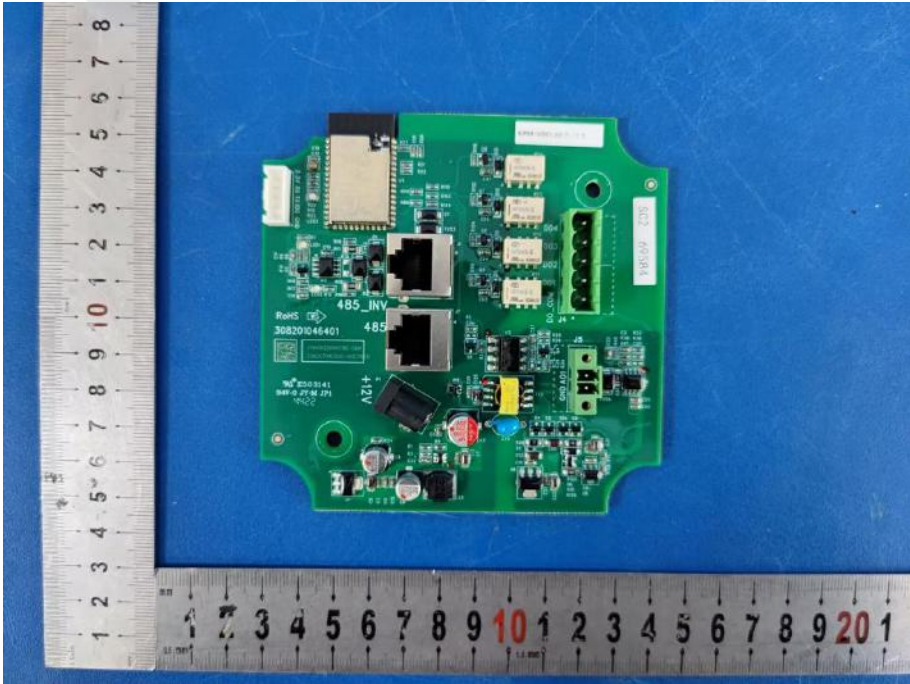
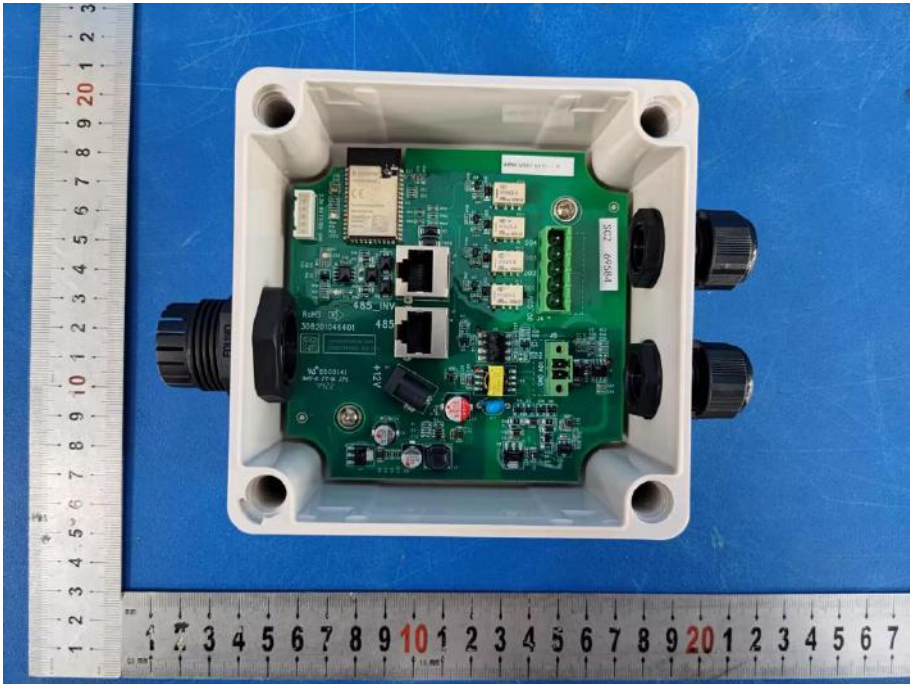

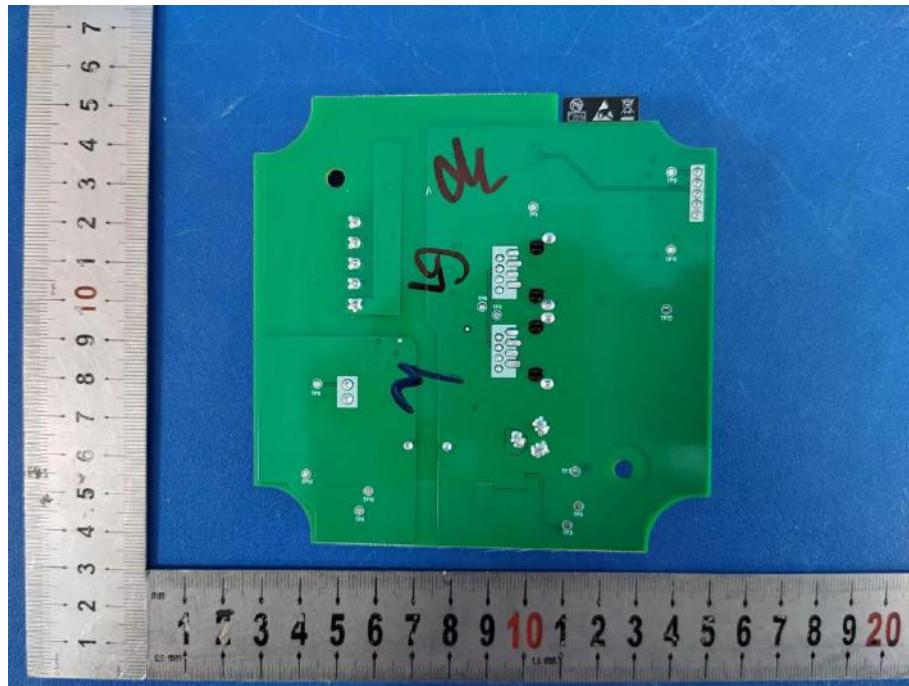





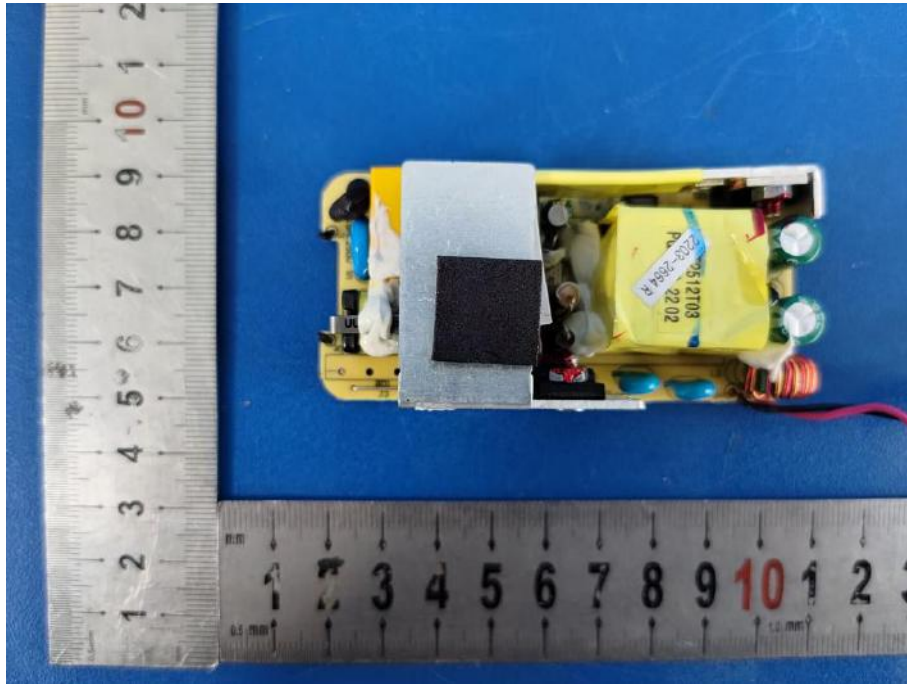

\*\*\* End of Report \*\*\*

# 声明 Statement

1. 本报告无授权批准人签字及“检验检测专用章”无效；  
This report will be void without authorized signature or special seal for testing report.
2. 未经许可本报告不得部分复制；  
This report shall not be copied partly without authorization.
3. 本报告的检测结果仅对送测样品有效，委托方对样品的代表性和资料的真实性负责；  
The test results or observations are applicable only to tested sample. Client shall be responsible for representativeness of the sample and authenticity of the material.
4. 本检测报告中检测项目标注有特殊符号则该项目不在资质认定范围内，仅作为客户委托、科研、教学或内部质量控制等目的使用；  
The observations or tests with special mark fall outside the scope of accreditation, and are only used for purpose of commission, research, training, internal quality control etc.
5. 本检测报告以实测值进行符合性判定，未考虑不确定度所带来的风险，本实验室不承担相关责任，特别约定、标准或规范中有明确规定的除外；  
The test results or observations are provided in accordance with measured value, without taking risks caused by uncertainty into account. Without explicit stipulation in special agreements, standards or regulations, EMTEK shall not assume any responsibility.
6. 对本检测报告若有异议，请于收到报告之日起 20 日内提出；  
Objections shall be raised within 20 days from the date receiving the report.