

BY SOLAX
TRIPLE
POWER

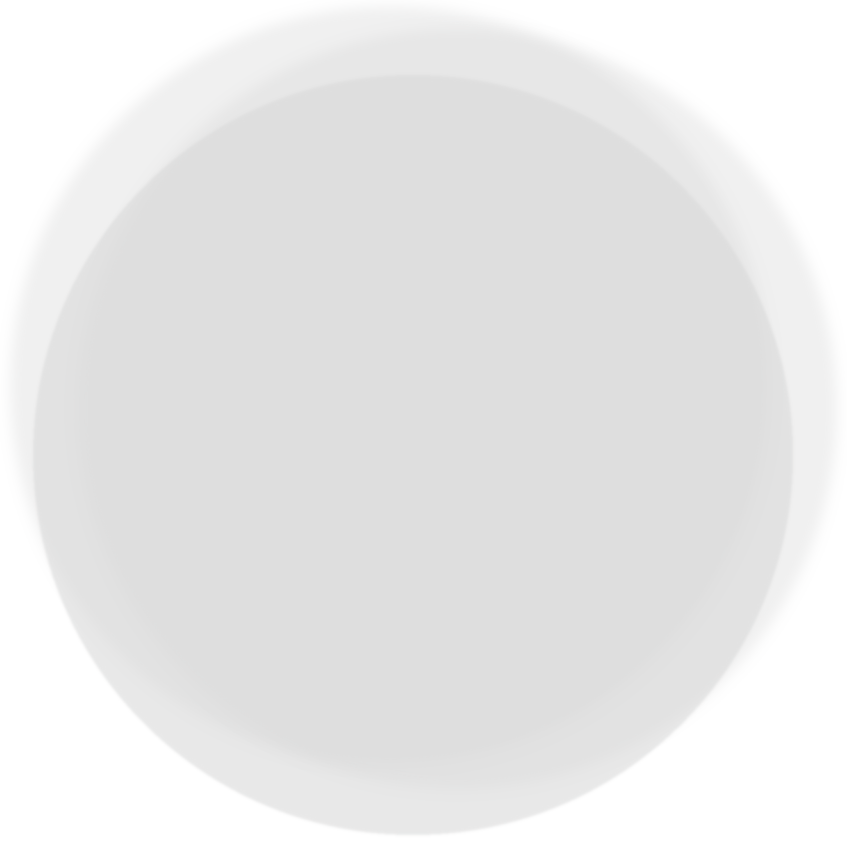

www.solaxpower.com

eManual in the QR code or at
<http://kb.solaxpower.com/>

Table of Contents

Safety.....	1
Installation.....	13

Safety

















General Notice

1. Contents may be periodically updated or revised. SolaX reserves the right to make improvements or changes in the product(s) and the program(s) described in this manual without the prior notice.
2. The installation, maintenance and grid-related setting can only be performed by qualified personnel who:
 - Are licensed and/or satisfy state and local jurisdiction regulations;
 - Have good knowledge of this manual and other related documents.
3. Before installing the device, carefully read, fully understand and strictly follow the detailed instruction of the user manual and other related regulations. SolaX shall not be liable for any consequences caused by the violation of the storage, transportation, installation, and operation regulations specified in this document and the user manual.
4. Use insulated tools when installing the device. Individual protective tools must be worn during installation, electrical connection and maintenance.
5. Please visit the website www.solaxpower.com of SolaX for more information.

Safety Instruction

For safety reasons, installers are responsible for familiarizing themselves with the contents of the Manual and all warnings before performing installation.

Descriptions of Labels

	CE mark of conformity		TUV certification
	RCM mark of conformity		Grounding point
	Additional grounding point		Caution, risk of danger
	The battery module may explode.		Caution, risk of electric shock
	Caution, hot surface		Do not operate this inverter until it is isolated from mains and on-site PV generation suppliers.
	Read the enclosed documentations.		Keep the battery system away from children.
	Keep the battery system away from open flames or ignition systems.		Do not dispose of the battery module together with household waste.
	Danger of high voltage. Do not touch live parts for 15 minutes after disconnection from the power sources.		The battery system must be disposed of at a proper facility for environmentally-safe recycling.



To prevent personal injuries and equipment damage, strictly do as follows in the process of operation:

- DO NOT power on while installing the device. If the device is powered on in the process of installation and disassembly of cables, an electric arc, electric spark or fire will occur at the moment that the cable core contacts conductors. It may cause a fire or result in physical and property damage.
- DO NOT improperly operate while powering on. Any improper operation may cause a fire, electric shock, or explosion, and it will result in physical and property damage.
- MUST remove rings, bracelets, watches, and any other metal jewelry from fingers, hands, or wrists before operation, to avoid electrical shock or burn.
- MUST use special insulation tools, of which the insulation grade and dielectric strength level must be consistent with local laws, regulations, standards, and guidelines, in the operation process, to avoid electrical shock, burn, or short circuit fault.
- A safety helmet, belt, or rope must be worn when performing work at height. If the safety rope is adopted, one end must be securely tied to a strong structural part instead of a movable and unsound object or a metal with sharp edges, to prevent fall incidents due to the slip of the rope hook.



The installation site shall meet the following requirements:

- Keep away from combustibles and explosive materials.
- Keep away from heat or fire sources, such as fireworks, candles, heaters, or any other heat-producing appliances. It may cause damage to equipment or a fire.
- Keep away from flammable and explosive gases, or smoky environments.



To prevent personal injuries and equipment damage, strictly do as follows when installing the batteries:

- Do not connect the positive and negative poles of a battery together. Or, the battery may be short-circuited. A short circuit may cause enormous amounts of current and release large quantities of energy for a short time, which may cause the battery to leak, smoke, release flammable gases, or be in thermal runaway, catch fire, or explode. Therefore, power off the battery before maintenance.
- Do not connect the positive and negative poles of a battery together. Or, the battery may be short-circuited. A short circuit may cause enormous amounts of current and release large quantities of energy for a short time, which may cause the battery to leak, smoke, release flammable gases, or be in thermal runaway, catch fire, or explode. Therefore, power off the battery before maintenance.
 1. Direct sunlight;
 2. Fire source;
 3. Heater;
 4. Others conditions that can cause overheating.
- Never damage the device by crushing, deforming, dropping, impacting, cutting or penetrating with a sharp object. Otherwise, it may cause a fire or leakage of electrolytes;

 **DANGER!**

To prevent personal injuries and equipment damage, strictly do as follows when installing the batteries:

- Never dismantle, change or damage battery, including penetrating with a sharp object, deforming, soaking in water or other liquids, to keep it away from leakage, smoke, release of flammable gases, thermal runaway, fire or explosion.
- Do not touch battery terminals with any other metal objects, which may cause heat or leak.
- Do not mix different types or makes of the battery module. It may cause leakage or rupture, resulting in personal injury or property damage.
- The battery electrolyte is toxic and volatile. Never get contact with the leaked liquids or inhale gases in the case of the battery leakage or odor. In such a case, keep away from the battery and contact professionals immediately. Those professionals must wear PPE, such as safety glasses, safety gloves, gas masks, protective clothing, etc., power off the equipment, remove the battery, and contact technical engineers.
- Normally, the battery will not release any gases since it is an enclosed system. However, in the following situations: burnt, needle-pricked, squeezed, struck by lightning, overcharged, or subject to other adverse conditions that may cause battery thermal runaway, the battery may be damaged or an abnormal chemical reaction may occur inside the battery, resulting in electrolyte leakage or production of gases. To prevent fire or device corrosion, ensure that flammable gas is properly exhausted.
- Take steps to protect human beings from the gases released when burning the batteries.

 **DANGER!**

To prevent personal injuries and equipment damage, strictly do as follows when carrying out wiring:

- Before wiring, check that the device is intact to prevent electric shock or a fire.
- Improper operation may cause a fire, electric shock, etc.
- Prevent any objects from entering into the device when operating. Otherwise, the device may be short-circuited or damaged, the load's power supply may be derated or powered off, or personal injuries may occur.

 **WARNING!**

Operators shall strictly do as follows to prevent personal injuries and equipment damage:

- Must wear special personal protective equipment (PPE), such as a coverall, safety boots, safety glasses, safety helmet, safety gloves, etc.
- The equipment installation site should keep away from liquid areas, such as positions under a water pipe or air outlet where the condensed water is easy to form, or positions under an air-conditioning vent, ventilation opening or equipment room outlet where there is access to water. The water can seep into the internal components of the device, causing device damage and short circuits.
- Do not cover vents and cooling systems while running. Otherwise, it may cause a fire or equipment damage due to the high temperature.



Operators shall strictly do as follows to prevent personal injuries and equipment damage:

- To ensure that a complete set of tools is prepared, are firm and secure. They must pass the verification of professional authorities. DO NOT use any tools that are broken, failed to verify, or are expired.
- To prevent personal injury or equipment damage from slopping or collapsing of the cabinet because it is unstable, please check if the cabinet has been secured before installing and operating.
- Do not drill holes in the equipment. Otherwise, the sealing performance, electromagnetic shielding performance, or internal components or cables of the equipment will be destroyed, and it can even cause a short circuit on a circuit board if the metal dust generated by drilling enters into the device.
- Install batteries in a dry area. Do not install them under areas prone to water leakage, such as air conditioner vents, ventilation vents, feeder windows of the equipment room, or water pipes. Ensure that no liquid enters the equipment to prevent faults or short circuits.
- Equip with fire-fighting equipment, such as dry sand, carbon dioxide fire extinguisher, etc., when installing and commissioning according to construction standards and requirements. Make sure that the above-mentioned fire-fighting equipment conforms to local laws, regulations and standards.
- Before unpacking, and in the process of storage and transportation, ensure that the packing cabinets are intact and the batteries are correctly placed according to the labels on the packing cabinets. Do not place a battery upside down or vertically, lay it on one side, or tilt it. Stack the batteries according to the stacking requirements on the packing cabinets. Make sure that the batteries do not fall or get damaged. Otherwise, they will need to be scrapped.
- After packing, the batteries must be correctly placed in accordance with the requirements. Do not place a battery upside down or vertically, lay it on one side, or tilt or stack it. Make sure that the batteries do not impact, fall get damaged. Otherwise, they will need to be scrapped.
- Tighten the screws on copper bars or cables to the torque specified in this document. Periodically confirm whether the screws are tightened, check for rust, corrosion, or other foreign objects, and clean them up if any. Loose screw connections will result in excessive voltage drops and batteries may catch fire when the current is high.
- After batteries are discharged, charge them in time to avoid damage due to overdischarge.
- A device required to be grounding must be grounded firstly when conducting wiring. The PNGD cable must be disconnected finally after removing any other cables.

 CAUTION!

- Do not stop the safety switch on the equipment, and neglect the "Danger" sign, "Warning" sign, "Caution" sign, and "Notice" sign on the equipment, as well as safety precautions in the document.
- Must stop working at once, report to the relevant person in charge, and activate protection schemes in case of possible danger that may cause human injury and damage to equipment in the installation and operation process.
- Do not power on during the installation process, or before obtaining confirmation from professionals after finishing installation.
- Do not directly contact power supply equipment, or contact it with other conductors or wet objects.
- Do not touch the running fan with parts, screws, or installation tools, or keep hands clear when the fan is running, to avoid personal injury or property damage.
- Please evacuate and press the fire bell immediately, or call fire emergency number at once in the case of a fire.

 CAUTION!

Safety precautions for storage, installation and wiring:

- The storage area should be clean, dry, and well ventilated to prevent dust from entering, and condensed water from generating.
- Strictly observe technical specifications while installing and running the equipment. Or, it may affect the performance and safety of the equipment.
- Do not install, run or operate outdoor equipment or cables (including but not limited to carrying equipment, operating equipment, connecting cables, plugging or unplugging cables that connect to outdoor signal ports, working at heights, outdoor installation, etc.) in bad weather, such as thunderstorms, rain, snow, etc.
- Keep away from the following environments while installing the equipment: environments with dust, smoke, volatile gases, corrosive gases, infrared radiation, organic solvents, or a site with high salt.
- Keep away from environments with metal-conductive or magnetic-conductive dust.
- Keep away from areas suitable for fungus, mould, or other microorganism growth.
- Keep away from areas with strong shaking, serious noise pollution, or powerful electromagnetic interference.
- The installation site must conform to local laws and regulations, and relevant standards.
- The ground at the installation site must be firm and strong instead of having an adverse geological condition, such as soil with high water content, weak soils, or loose soils. And keep away from low-lying areas since they are prone to water or snow accumulation.
- Keep away from areas prone to water accumulation.
- If the equipment is installed on a grassy plantation, do weed regularly, and harden the ground under the equipment, such as cementing, gravelling, etc.
- When the operator plans to install, operate or maintain the equipment, water, snow, or other objects must be cleared on the top of the device before opening doors to keep them from entering into the device.
- Please check the ground is firm and strong enough to meet the load-bearing requirements of the equipment while it is being installed.
- Charge the battery within the specific temperature range because the low temperature may result in short circuit. Hence, do not charge the battery if the temperature is below the low limit of the operating temperature.



Safety precautions for storage, installation and wiring:

- Ensure that the packing cabinets are intact before unpacking. Do not use if package is damaged, and contact forwarder and manufacturer immediately.
- May leak electrolytes or release flammable gases if the battery is damaged, including dropping, crashing, bulging, or housing indentation. Do not use in the case of the above-mentioned circumstances. Please immediately contact the installer or professional operation and maintenance staff to remove or change the battery in the case of leakage of electrolytes or structural distortion. Keep the damaged battery away from other devices or inflammable and explosive materials, and ensure that non-professional personnel do not contact the damaged batteries.
- Ensure that the pungent and burning smells go away before operating.
- Do not place any objects, like tools, metal parts, etc., on top of the battery. Check and clean them up if any.
- Do not install batteries in rain, snow, fog, or other extreme weather, to prevent moisture or corrosion.
- Do not install batteries after moisturizing, transport to an isolation area, and be scrapped.
- Check if the shell of the battery is deformed or damaged before installing. If yes, do not install it.
- Check whether the positive and negative terminals of the battery are accidentally grounded. If yes, disconnect them.
- Do not weld or grind near the battery. Because an electric spark or arc may cause a fire.
- Store or recharge the battery according to the document if it is not used for a long time.
- The devices used to charge or discharge the batteries must meet the requirements of local laws, regulations, and standards.
- Power off the battery when installing and maintaining.
- Inspect the damaged battery to ensure that there is no smoke, fire, leakage of electrolytes, or heat in the period of storage.
- Do not contact the battery when it fails because of the high temperature of the surface.
- Do not step, against, or stand on the battery.
- The batteries are not allowed to be used to provide a backup power source in the following circumstances:
 - a. Medical equipment that is directly related to human health.
 - b. Equipment, like trains, elevators, etc., that may cause injuries to human beings.
 - c. Computer systems that play an important role in societies and institutions.
 - d. Nearby area with medical equipment.
- Must seal the entry holes.
- Must clean the packing materials, such as cartons, foams, plastic bags, ties, etc., on the site after finishing installation.
- Do not install cables near air inlet (or outlet) of the device.
- Please read the document carefully before installation, operation and maintenance.

 CAUTION!**Safety precautions for handling:**

- To prevent injury from oversize loads, assess the device you're about to lift before you start lifting.
- If more than 2 people lift a device, reasonably arrange to have a balanced weight distribution
- Wear personal protective equipment, such as, safety gloves, safety boots, etc., to prevent needless injuries when lifting devices with bare hands.
- Know the right body posture to prevent personal injuries when lifting devices, for instance, bend at your knees, not at your waist or back, and do not twist your back.
- Hold the handles on the device or put your hands underneath the device to move or lift, and do not hold the handles on the parts installed in it.
- To prevent injuries, do not quickly lift the heavy device above the waist.
- To prevent scratches and dents, or damage to components and cables, avoid impact and falling when moving.
- Be aware of workbenches, slopes, steps, and other places where it is easy to slip when moving devices. Ensure that the passageways are smooth, clean, and away from obstacles.
- To prevent tipover, the forklift's forks must be placed under the load. Center the weight of the load between the forks, and adjust the forks to distribute the weight evenly. Firmly attach the loads to the forks before lifting, and arrange for people to watch for when lifting.
- Sea and road (in good condition) transports are an idea for the device instead of rail and air transports. Transport staff should do their best to avoid bumpiness and inclination as much as possible.

 CAUTION!**Safety precautions for working at heights:**

- Arrange people to protect workers who work at 2 meters in height or higher.
- Workers who work at 2 meters in height or higher are required to be trained and obtain relevant qualifications.
- In the case of one of the following circumstances, workers should immediately stop operation until the device is inspected and confirmed safe by the relevant safety director and technicians.
 1. Wet steel pipe; 2. Other situations may be dangerous.
- Should mark off a dangerous area, put up Danger signs, and keep unauthorized people from entering the area.
- Should install guardrails and put up "Watch Your Step" and Danger signs at the edges of workplace and holes.
- Do not stack scaffoldings, gangplanks, or other sundries, and keep the ground service staff from staying or passing under the area where the work is being carried out.
- Take caution with the apparatus and tools brought to ensure that they do not fall.
- Workers who work at heights should take advantage of crane slings, baskets, elevating transfer vehicles, cranes, or other methods to transfer objects instead of throwing them from the air to the ground or from the ground to the air.

 CAUTION!

Safety precautions for working at heights:

- Should avoid working on the up and down work platform at the same time. Or, a special protective shed should be built or some protective measures should be taken between two work platforms to protect workers. In addition, do not stack tools and materials on the upper work platform.
- The scaffoldings should be removed from top to bottom instead of being removed at the same time after finishing installation. Take caution when dismantling parts of scaffolding.
- Workers who work at heights must abide by the Safety Regulation for Working at Heights. SolaX will not be liable for personal injury or equipment damage due to violations of the Regulation.
- Do not play and have a break in the area while working at heights.

 CAUTION!

Ladder safety:

- A wood or insulated ladder should be used when working with electricity.
- A platform ladder with handrails is preferred instead of a straight ladder.
- Check that the ladder is in good condition, make sure that the load bearing meets requirements, and strictly prohibit overload.
- Place the ladder on a solid and firm surface, and designate a person to hold it.
- Balance your body to prevent injuries when climbing.
- Make sure that the rope is fastened and secured when using the herringbone ladder to prevent incidents.

 CAUTION!

Crane safety:

- Crane operators are required to be adequately trained, and certified and licensed to operate said equipment before starting work.
- Must install guardrails and put up Warning signs at the crane working area.
- The groundwork for the hoisting operation must meet the load bearing requirements of the crane.
- Make sure that the hoisting tools have been secured to an object or wall that meets the load bearing requirements before hoisting.
- Keep the ground service staff from staying or passing under the crane boom or suspended load where the work is being carried out.
- Do not drag steel wire rope, wire rope slings, etc., and hit hoisting equipment with hard objects, when hoisting work is being carried out.
- Make sure that the angle between two wire ropes do not exceed 90° when hoisting.

CAUTION!

Drilling safety:

- Wear personal protective equipment when drilling, such as safety glasses, safety gloves, etc.
- Avoid drilling around pipes, and light switches and sockets, as the electrical wires can go horizontally and vertically around these fixtures.
- Cover the device to protect it from dusts and debris entering when drilling, and clean it at once after finishing drilling.

NOTICE!

- Use electrical tape to wrap the exposed wire outwards to prevent short circuit when installing and maintaining.
- Prevent any object from entering into batteries.
- Please strictly follow the steps described in the document before installing, operating and maintaining the device. Do not modify or change the device, and adjust the installation procedure.
- Permission shall be obtained from the state or local electrical department before conducting the grid connection.
- Abide by the safety regulations stipulated by the power station.
- Mark off an operation area, install a temporary fencing or rope, and put up "No Entry" signs.
- Power off the device and shut down switches before connecting or disconnecting power cables.
- Power off the device at once and do not use again if there are any liquids entering into it.
- Check and confirm whether the tools meet the requirements described in the document before operating the device, and be registered. Check whether the number of tools is correct after installing and operating it.
- Check that the icons on the cable labels are correct before connecting power cables. Ensure that the terminals are completely covered with insulation.
- Ensure that protective shell or insulation sleeving on the electrical components are correctly installed to protect operators from electric shock.
- In the case of multiple inputs, disconnect them first; do not operate the device until it is completely powered off.
- Turn off the corresponding output switch of the power supply equipment while maintaining electrical terminal equipment and power distribution equipment connected to the power supply equipment.
- Must put up "Do Not Switch On" signs and warning signs, to prevent power connection. Do not switch on before the fault is repaired.
- Must follow the steps below if the device needs a power cut in the process of fault diagnosis and troubleshooting: power cut > electricity testing > connecting grounding cable > putting up warning signs and installing guardrails.
- Periodically check whether the screws are tightened fully.
- Only professionals can change the damaged cables.
- Do not alter, damage or obscure the logos and labels attached to the devices.
- Do not clean the internal and external parts of the device with solvents, like water, alcohol or oil.

NOTICE!

Grounding requirements:

- The equipment grounding impedance shall meet the requirements of the local electrical code.
- The equipment shall be permanently connected to a grounding wire within the building's electrical system. Check that the equipment is reliably grounded.
- Do not operate the equipment before connecting it to the equipment grounding connector.
- Do not damage the equipment grounding connector.
- Make sure that the grounding pin in the 3 pin plug is connected to a grounding wire within the building's electrical system in the case of the 3 pin plug.
- In the case of high-current equipment, it shall be ensured that the protective grounding terminal of the device shell has been grounded.

NOTICE!

Wiring requirements:

- Must abide by the local laws, regulations and standards to select, install, and route cables.
- Do not circle or twist cables. Change the power cable if the cable length is insufficient instead of joining it.
- Make sure that cables are secured and well-insulated, and meet specifications.
- Cable troughs or holes must be smooth, burr-free working surface to prevent cable damage.
- Suggest to use cable ties to bind cables to ensure that the cables inside the cabinet are tidied, and to prevent cable jacket damage. Do not circle or twist cables.
- Use fireproofing mud immediately to seal the cable holes if you need to leave for a while after finishing wiring or in the process of wiring, to prevent water vapor and small animals.
- If the external conditions (routing method, temperature, etc.) change, the cable type must be verified according to IEC-60364-5-52 or local laws, regulations and standards. For instance, verify whether the cable ampacity meets the requirements.
- The cable insulation layer may be aging, and even damaged in a high temperature environment. Therefore, at least 30 mm of distance shall be kept between the cables and heater or periphery of heat sources.
- Do as follows to prevent cables from brittle cracking due to shocking or shaking in the low temperature environment, and ensure operation safety:
 1. Handle gently when installing cables in a low temperature environment above 0°C.
 2. Must move the cables indoors and leave them for more than 24 hours before installing them, if the previous storage temperature is below 0°C.
- Do not throw cables to prevent damage and deteriorate performance, such as current capacity, temperature, etc.

NOTICE!

The static electricity generated by human beings can damage the static-sensitive components on the board, like large scale integrated circuit. Therefore, please follow the steps below to prevent static electricity:

- Operators must wear anti-static clothing, and anti-static gloves or wrist straps before contacting the boards, modules with exposed circuit boards, or application specific integrated circuits (ASIC). If the anti-static wrist strap is used, hook up the metal clip that's on one end to a grounded and unpainted metal surface.
- Hold the circuit board or the modules with exposed circuit board by its edges without components. Do not contact the components.
- Use anti-static materials to pack the removed boards or modules before storage or transportation.

NOTICE!

In case the battery module leaks electrolyte or any other chemical materials, or gas may be generated due to the leakage of battery module, be sure to avoid contact with the discharge at all times. In case of accidentally coming into contact with them, please do as follows:

- In case of inhalation: Leave the contaminated area immediately, and seek medical attention at once;
- In case of contact with eyes: Rinse eyes with running water for 15 minutes, and seek medical attention;
- In case of contact with skin: Wash the contacted area thoroughly with soap, and seek medical attention;
- In case of ingestion: Induce vomiting, and seek medical attention.

NOTICE!

If a fire breaks out where the battery module is installed, please do as follows:

- In case the battery module is charging when the fire breaks out, provide it is safe to do so, disconnect the battery module circuit break to shut off the power charge;
- In case the device is not on fire yet, use a Class ABC fire extinguisher or a carbon dioxide extinguisher to extinguish the fire;
- If the battery module catches fire, do not try to put out the fire, and evacuate immediately. In the case of severe fires, call the fire department immediately.
- The battery module may catch fire when it is heated above 302°F/60°C; and in case of catching fire, it will produce noxious and poisonous gas, DO not approach and keep away.

NOTICE!

Effective ways to deal with accidents:

- In case of the damaged battery module, place it into a segregated place, and call the local fire department at the place where the user lives or qualified personnel.
- If any part of the battery module, or wiring is submerged, do stay out of the water and do not touch anything; If the battery module gets wet, don't touch it.
- If the battery module is damaged, don't use it. Otherwise, it may result in both personal injury and property damage.
- Don't use the submerged battery module again, and contact the qualified personnel.

NOTICE!

Recovery of damaged or wasted battery:

- Dispose of the damaged or wasted batteries according to local laws and regulations instead of placing them in the household trash or in curbside recycling bins. Otherwise, it may cause environmental pollution or explosions.
- Contact our company or a battery recycling company to scrap the battery, if it leaks electrolytes, or is damaged.
- Contact a battery recycling company to scrap batteries if they are expired.
- Keep the damaged or wasted batteries away from high temperatures and direct sunlight.
- Ensure that the damaged or wasted batteries are not exposed to the following environments: high humidity, corrosion.
- Do not recycle the damaged or wasted batteries for a second use, and immediately contact a battery recycling company to scrap them. Or, it may cause environmental pollution.

NOTICE!

The static electricity generated by human beings can damage the static-sensitive components on the board, like large scale integrated circuit. Therefore, please follow the steps below to prevent static electricity:

- Operators must wear anti-static clothing, and anti-static gloves or wrist straps before contacting the boards, modules with exposed circuit boards, or application specific integrated circuits (ASIC). If the anti-static wrist strap is used, hook up the metal clip that's on one end to a grounded and unpainted metal surface.
- Hold the circuit board or the modules with exposed circuit board by its edges without components. Do not contact the components.
- Use anti-static materials to pack the removed boards or modules before storage or transportation.

Packing List / Packliste / Liste du matériel livré / Lista de piezas / Lista da embalagem / Paklijst / Contenido della confezione / Zawartość opakowania / Seznam balení / Packlista / Listă de ambalare / Опаковъчен лист / Pakkeliste / Λίστα συσκευασίας / Pakkeleht / Pakkausluettelo / Popis pakiranja / Csomaglista / Pakuotės turinys / Iepakojuma saraksts / Zoznam položiek balenia / Seznam pakiranja / Kutu Listesi / Lista de Embalagem

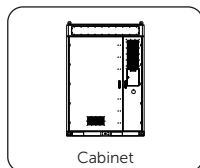

Cabinet

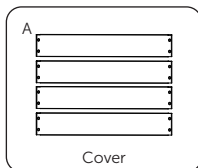

Cover

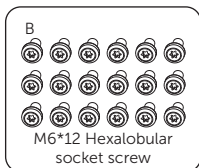

M6*12 Hexalobular socket screw

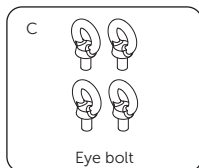

Eye bolt

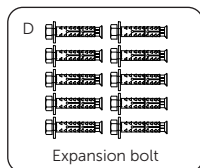

Expansion bolt

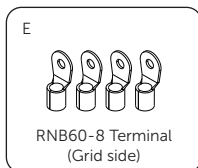

RNB60-8 Terminal (Grid side)

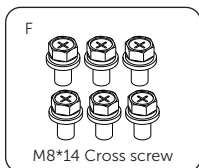

M8*14 Cross screw

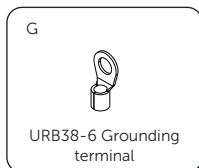

URB38-6 Grounding terminal

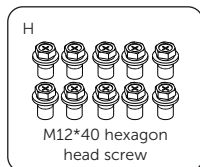

M12*40 hexagon head screw



Fireproof mud

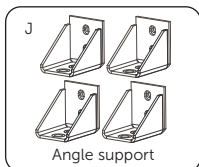

Angle support

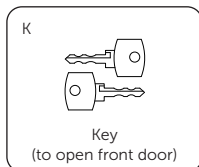

Key (to open front door)

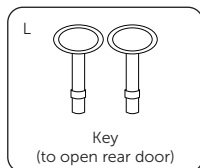

Key (to open rear door)

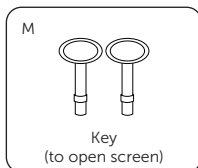

Key (to open screen)

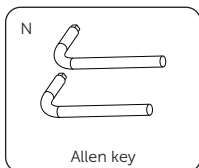

Allen key

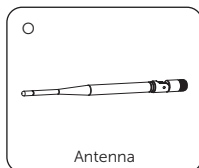

Antenna

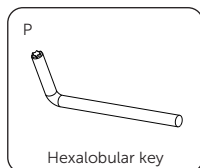

Hexalobular key

Item No.	Items	Quantity
/	Cabinet	1 pc
A	Cover	4 pcs
B	M6*12 Hexalobular socket screw	18 pcs
C	Eye bolt	4 pcs
D	Expansion bolt	10 pcs
E	RNB60-8 Terminal (Grid side)	4 pcs
F	M8*14 Cross screw	6 pcs
G	URB38-6 Grounding terminal	1 pc
H	M12*40 hexagon head screw	10 pcs
I	Fireproof mud	2 kg

Item No.	Items	Quantity
J	Angle support	4 pcs
K	Key (to open front door)	2 pcs
L	Key (to open rear door)	2 pcs
M	Key (to open screen)	2 pcs
N	Allen key	2 pcs
O	Antenna	1 pc
P	Hexalobular key	1 pc

Installation Site / Installationsort / Site d'installation / Sitio de instalación / Local de instalação / Installatiesite / Sito di installazione / Miejsce instalacji / Místo instalace / Installationsplats / Loc de instalare / Монтажен объект / Monteringssted / Τόπος εγκατάστασης / Paigaldamise koht / Asennuspaikka / Lokacija ugradnje / Telepítési helyszín / Montavimo vieta / Uzstādīšanas vieta / Miesto inštalácie / Mesto namestitve / Kurulum Yeri / Local de Instalação

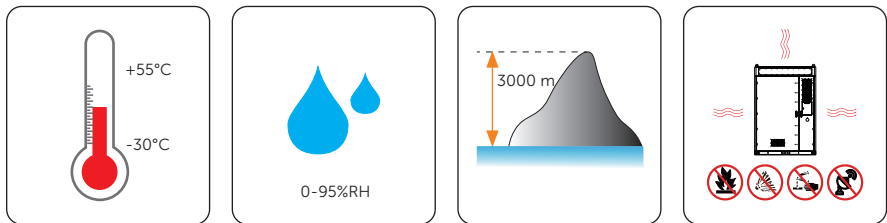

Installation Site	Distance
Distance from the device to the coast	> 2000 m
Distance from the device to the high heavily polluted area, for instance, smelting plant, coal mine, thermal power plant, etc.	1500 m ~ 3000 m
Distance from the device to the moderately polluted area, for instance, chemical plant, rubber plant, electroplate factory, etc.	1000 m ~ 2000 m
Distance from the device to the lightly polluted area, for instance, food factory, leather factory, heating boiler, slaughter house, dumping site, sewage treatment plant, etc.	500 m ~ 1000 m

Fork Position

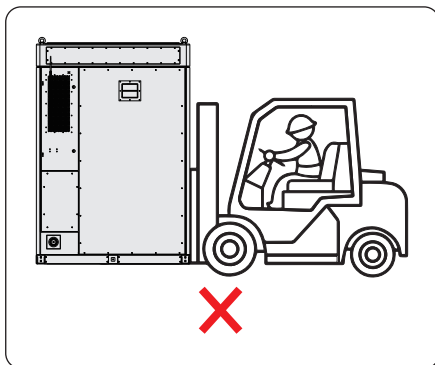
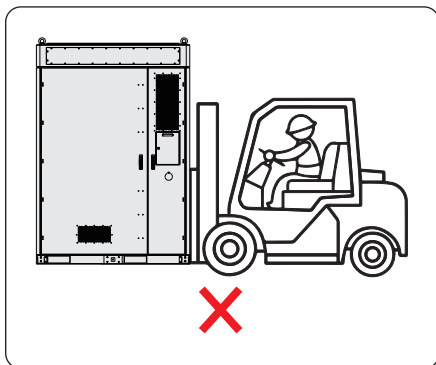
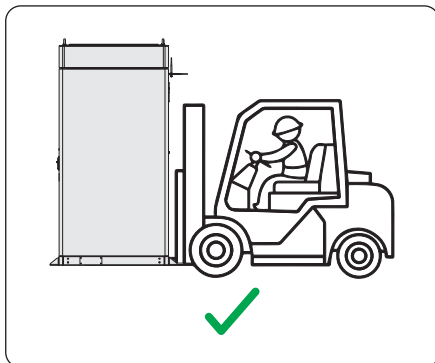
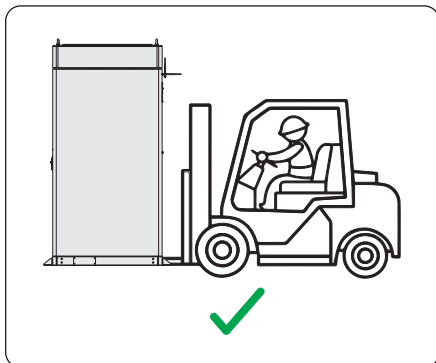

Installation Carrier / Installationsträger / Partie porteuse / Soporte de instalación / Suporte de Instalação / Installatiedrager / Supporto di installazione / Powierzchnia montażowa / Nosič instalace / Installationsfästen / Suport instalație / Монтажна основа / Monteringsholder / Μεταφορέας εγκατάστασης / Paigalduskandja / Aseennusteline / Nosač za ugradnju / Telepítési szolgáltató / Montavimo pagrindas / Instalācijas turētājs / Nosná konštrukcia pre inštaláciu / Namestitveni nosilec / Kurulum Taşıyıcı / Transportador de Instalação

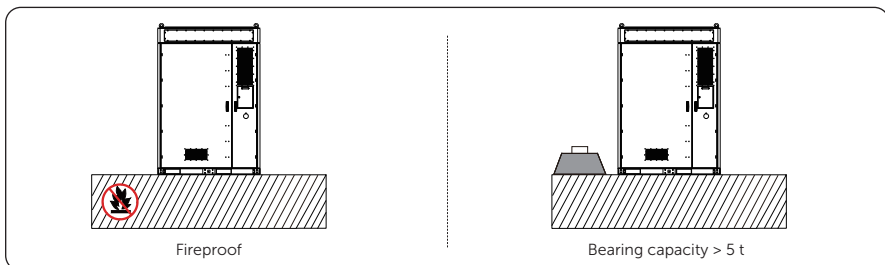

Dimension and Installation Foundation

Angle supports installed at front and rear sides

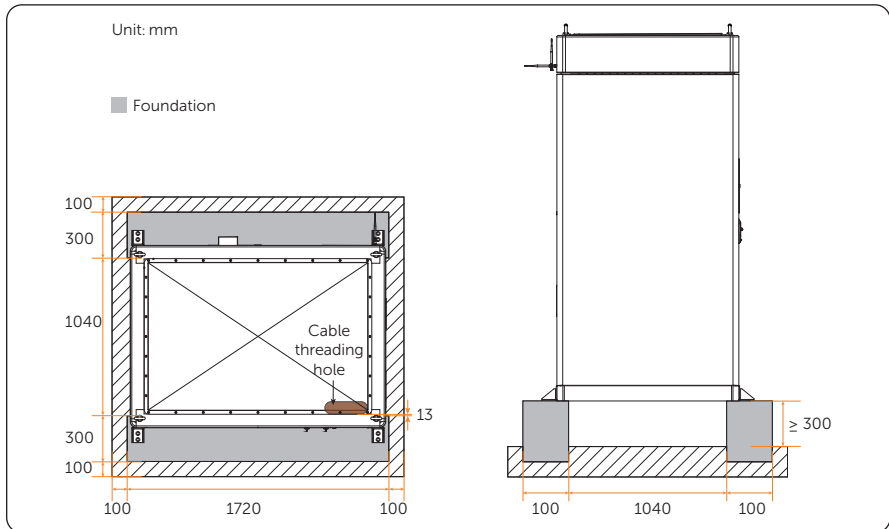
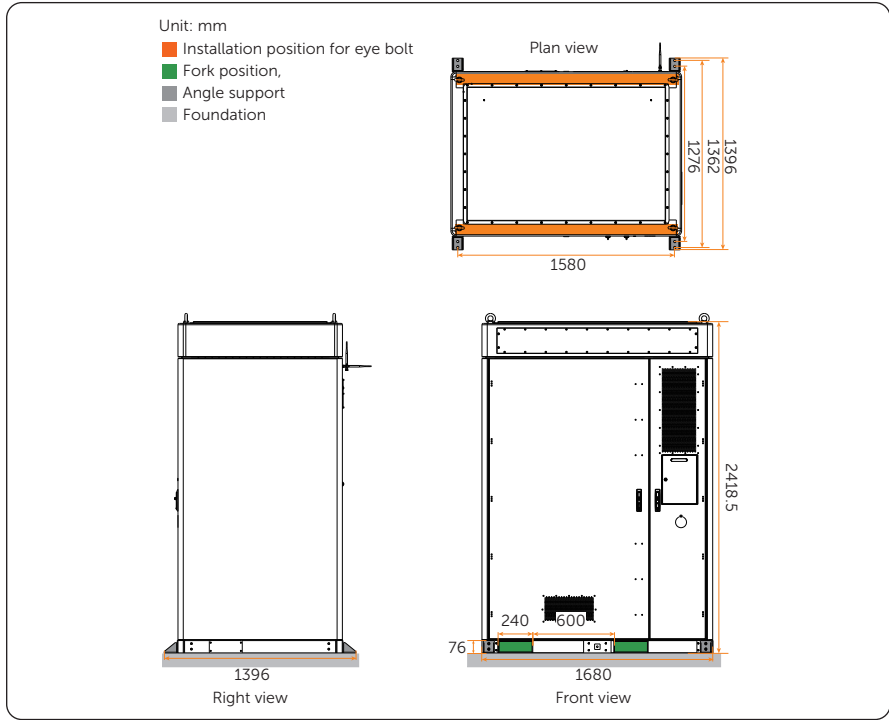

Angle supports installed at left and right sides

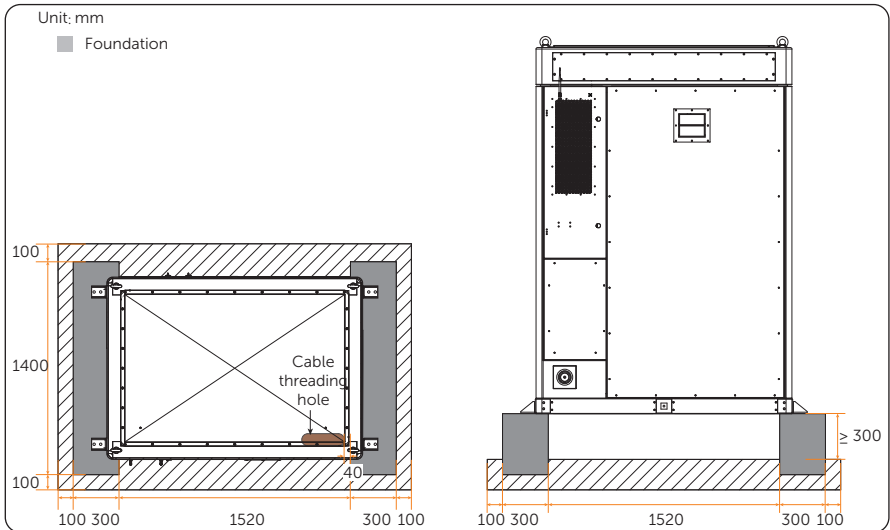
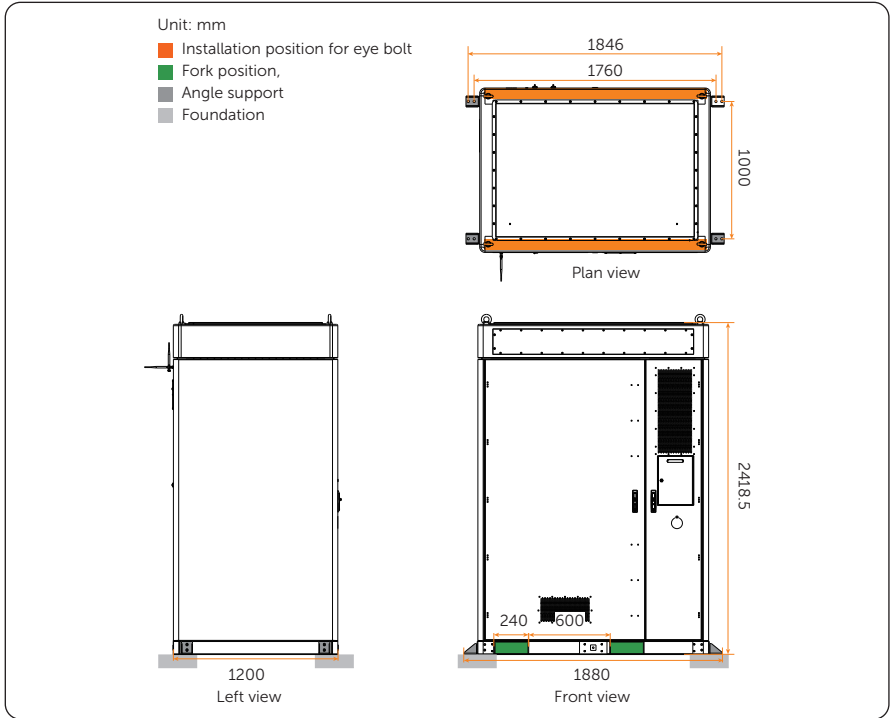

Installation Space / Installationsraum / Espace d'installation / Espacio de instalación / Espaço de instalação / Installatieruimte / Spazio di installazione / Przestrzeń instalacyjna / Instalační prostor / Installationsutrymme / Spațiu de instalare / Монтажно пространство / Monteringsplats / Χώρος εγκατάστασης / Paigaldusruum / Aseennustila / Mjesto ugradnje / Telepítési tér / Montavimo erdvė / Uzstādišanas telpa / Priestor pre inštaláciu / Prostor za namestitev / Kurulum Alanı / Espaço de Instalação

The device support the following installation options:

1. A single cabinet;
2. Multiple cabinets:
 - a. install separately (For the detailed installation space, refer to Figure 1);
 - b. install together (Refer to Figure 2).

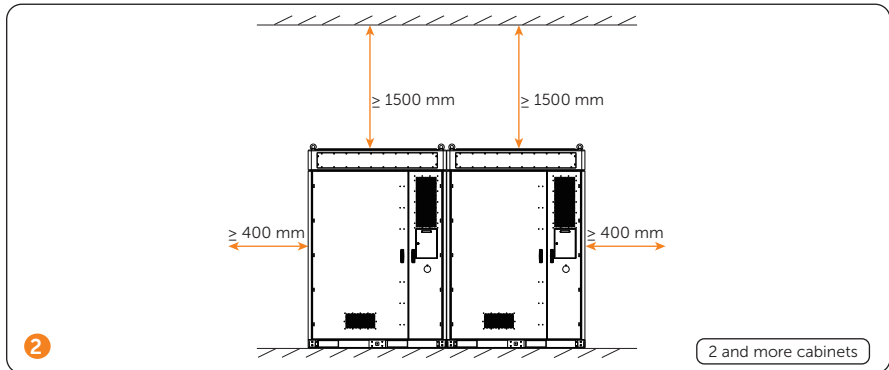
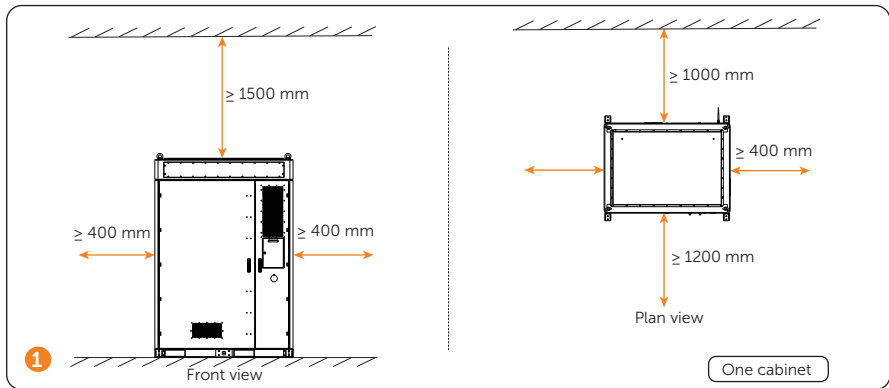

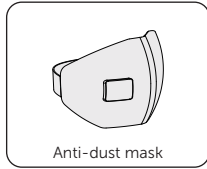
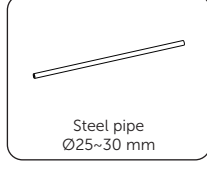
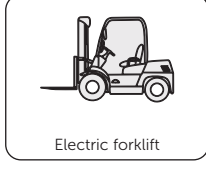
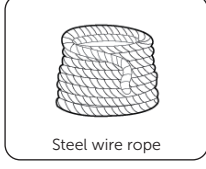
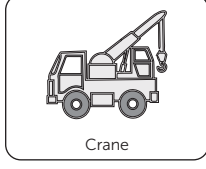
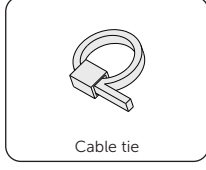
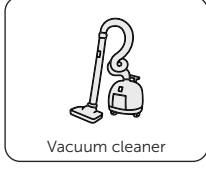
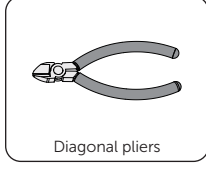
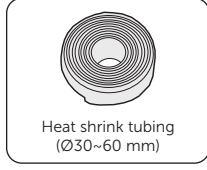
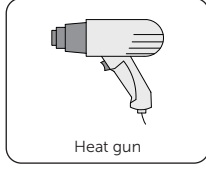
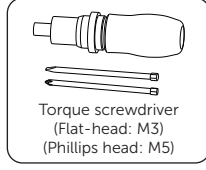
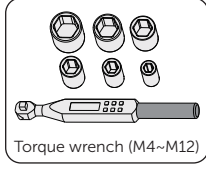
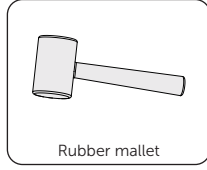
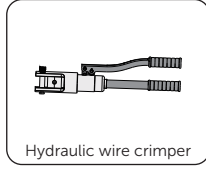
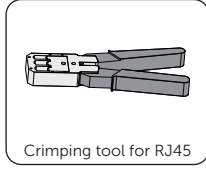
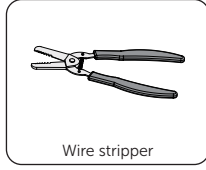
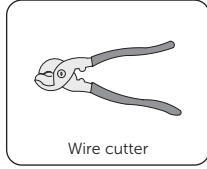
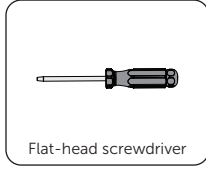
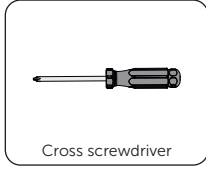
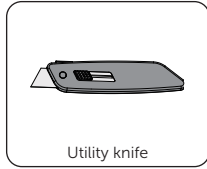
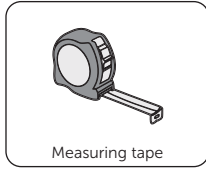
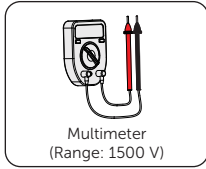
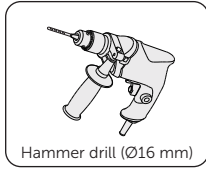

Installation Tools / Installationswerkzeuge / Outils d'installation / Herramientas de instalación / Ferramentas de instalação / Installatiemiddelen / Utensili di installazione / Narzędzia do instalacji / Instalační nástroje / Verktøy för installation / Instrumente de instalare / Монтажни инструменти / Monteringsværktøjer / Εργαλεία εγκατάστασης / Paigaldamise tööriistad / Aseennustyökalut / Alati za ugradnju / Telepítő eszközök / Montavimo įrankiai / Uzstādišanas instrumenti / Nástroje pre inštaláciu / Orodja za namestitev / Kurulum Araçları / Ferramentas de Instalação

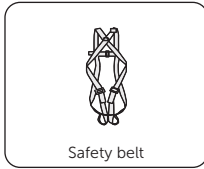
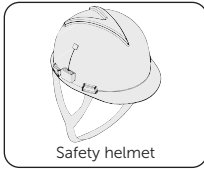



Additionally Required Materials / Zusätzlich erforderliche Materialien / Matériaux supplémentaires requis / Materiales adicionales necesarios / Materiais Adicionais Necessários / Extra benodigde materialmen / Materiali aggiuntivi necessary / Materiaty wymagane dodatkowo / Další požadované materiály / Ytterligere materialkrav / Materiale suplimentare necesare / Други необхідними матеріали / Yderligere nødvendige materialer / Πρόσθετα απαιτούμενα υλικά / Täiendavad vajalikud materjalid / Muut vaaditud materiaalit / Potrebni dodatni materijali / További szükséges anyagok / Papildomos reikalingos medžiagos / Papildus vajadzīgie materiāli / Dodatočne požadované materiály / Dodatno zahtevani materiali / Ayrıca Gereklı Malzemeler / Materiais Adicionais Necessários

No.	Required Material	Type	Conductor Cross-section
1	Grounding plate 	Galvanized iron plate	Width: 40 mm Depth: 4mm
2	Grid wire 	Five-core copper cable (copper wire)	$\geq (50 \text{ mm}^2 \cdot 4 + 25 \text{ mm}^2 \cdot 1)$

Mechanical Installation / Mechanische Installation / Installation mécanique / Instalación mecánica / Instalação mecânica / Mechanische installatie / Installazione meccanica / Instalacja mechaniczna / Mechanická instalace / Mekanisk installation / Instalare mecanică / Механичен монтаж / Mekanisk installation / Μηχανική εγκατάσταση / Mehaaniline paigaldus / Mekaaninen asennus / Mehanička ugradnja / Mechanikai telepítés / Mechaninis montavimas / Mehāniskā uzstādīšana / Mechanická inštalácia / Mehanska namestitev / Mekanik Kurulum / Instalação Mecânica

Note: If the eye bolts are required to be installed based on the actual situation, please strictly follow the steps below.

Installation of Eye Bolt (Optional)

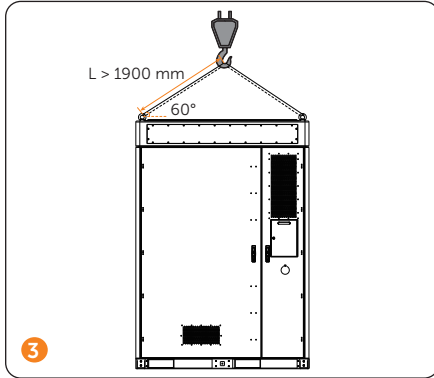
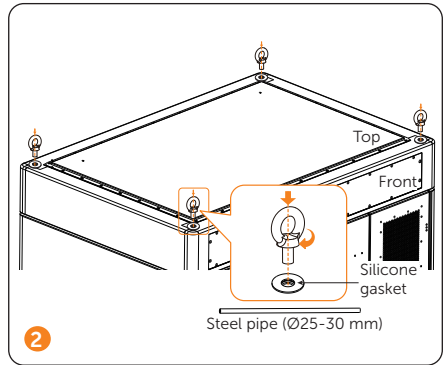
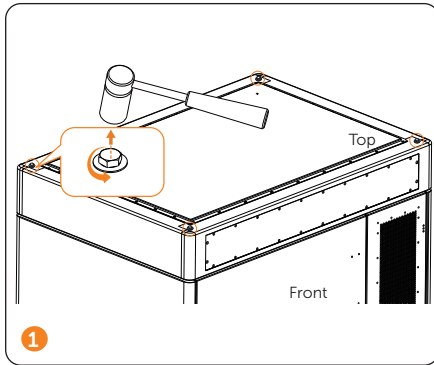

Note!

3. Regarding personal safety, please refer to ["Safety precautions for working at heights"](#).

Installation of Antenna

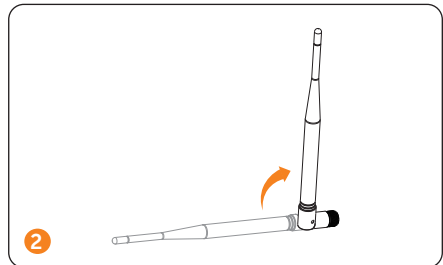
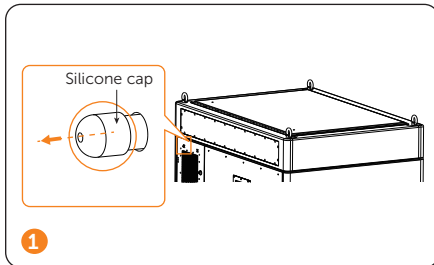

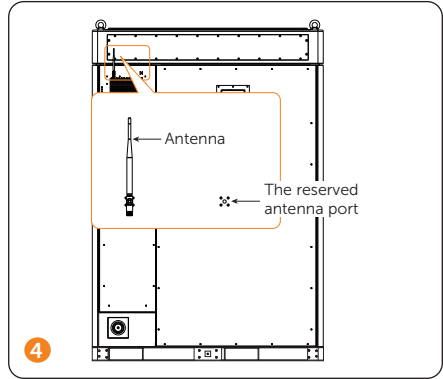
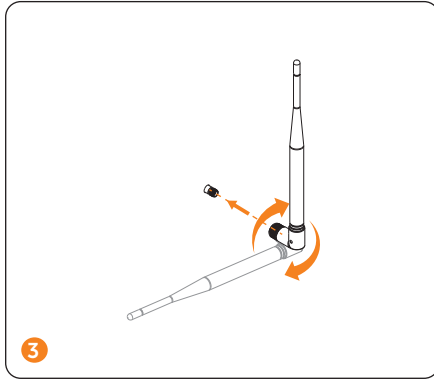

Note!

1. The user can decide whether the reserved port connects an antenna based on the actual situation.
2. Regarding the other antenna port (the right one), the antenna is delivered with the accessories kit.

Installation of Angle support and Cover

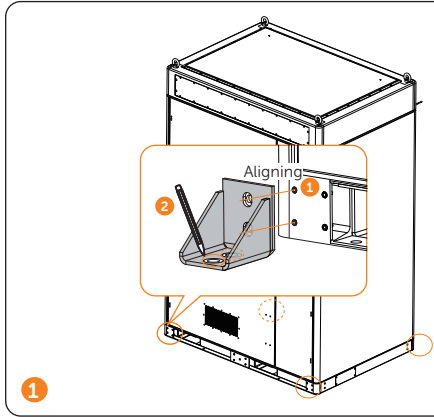

Align the holes in the cabinet,
Draw circles on the ground.

Note!

1. There are totalling 4 angle supports,
2. There are 2 pieces of expansion bolts and M12 screws for each angle support respectively, with a total of 8 pieces of expansion bolts and M12 screws, respectively.

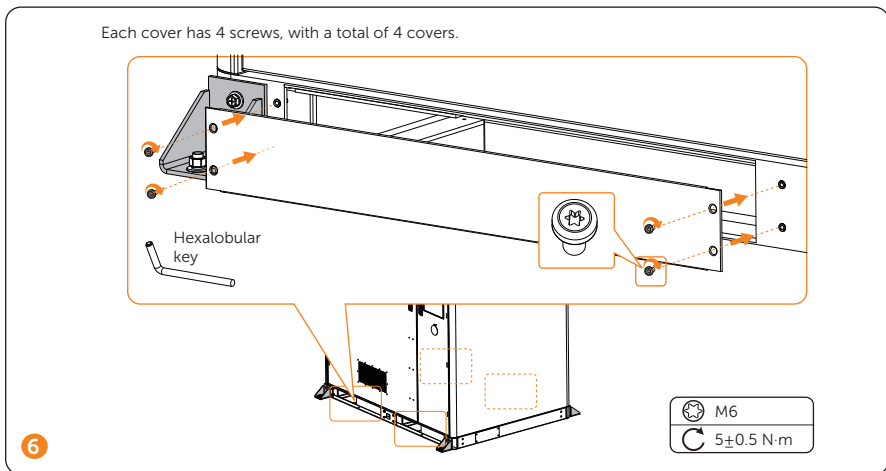
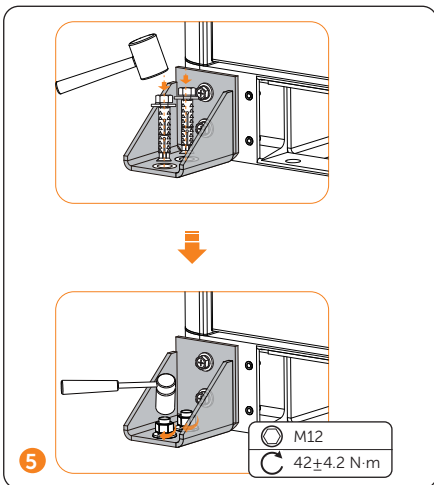
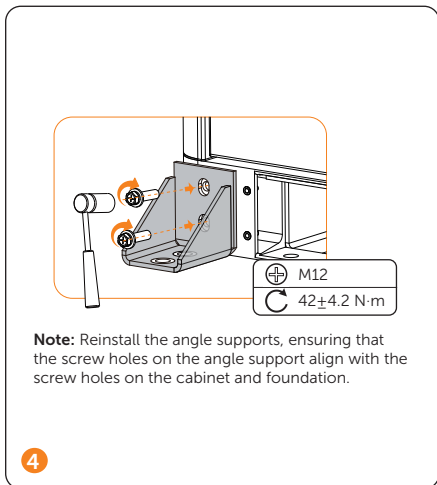
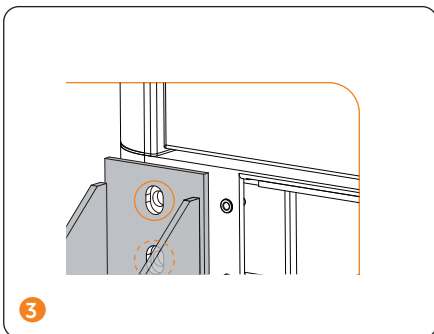
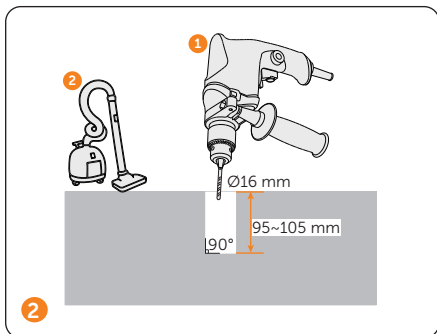

Wiring / Verkabelung / Câblage / Cableado / Ligação / Bedrading / Cablaggio
/ Połączenie przewodów / Zapojení / Kabeldragning / Cablare / Свързване /
Ledningsføring / Καλωδίωση / Juhtmed / Kytkenät / Ožičenje / Vezetékezés /
Elektros instaliacija / Elektroinstalācija / Zapojenje / Ožičenje / Kablolama / Fiação

Dismantlement of Cable Entrance Hole Cover before Wiring

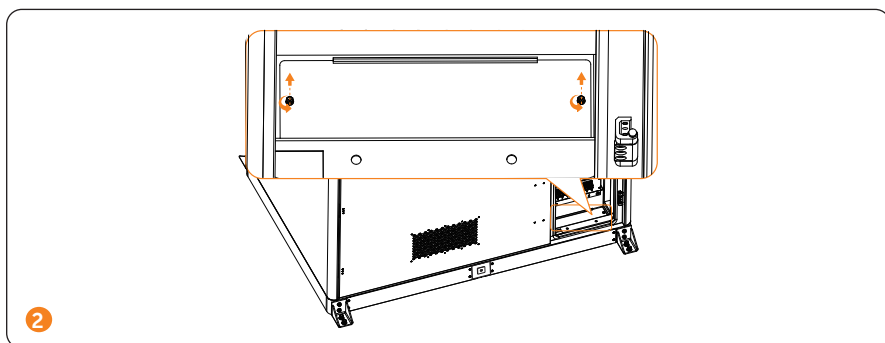
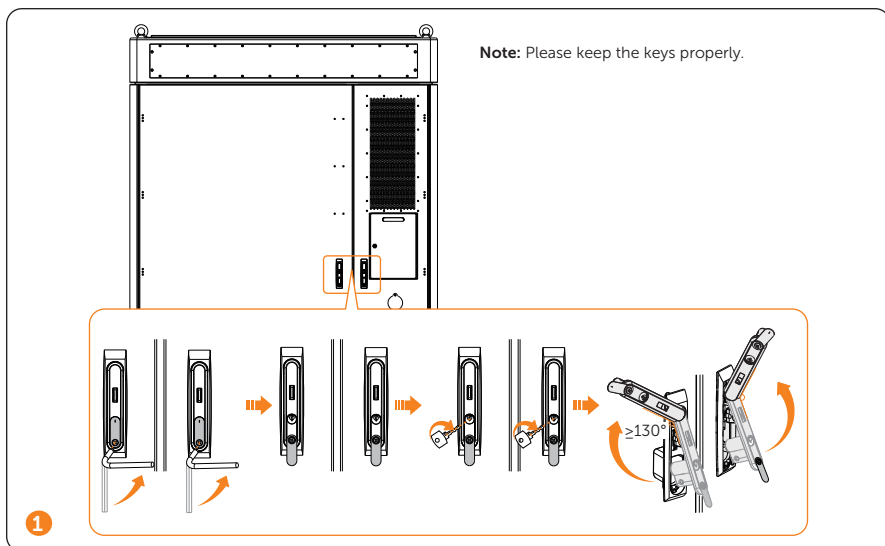

Parts that Need Wiring

Note!

Before wiring, operators are required to learn which parts need to be conducted wiring. For details, see the following figure.

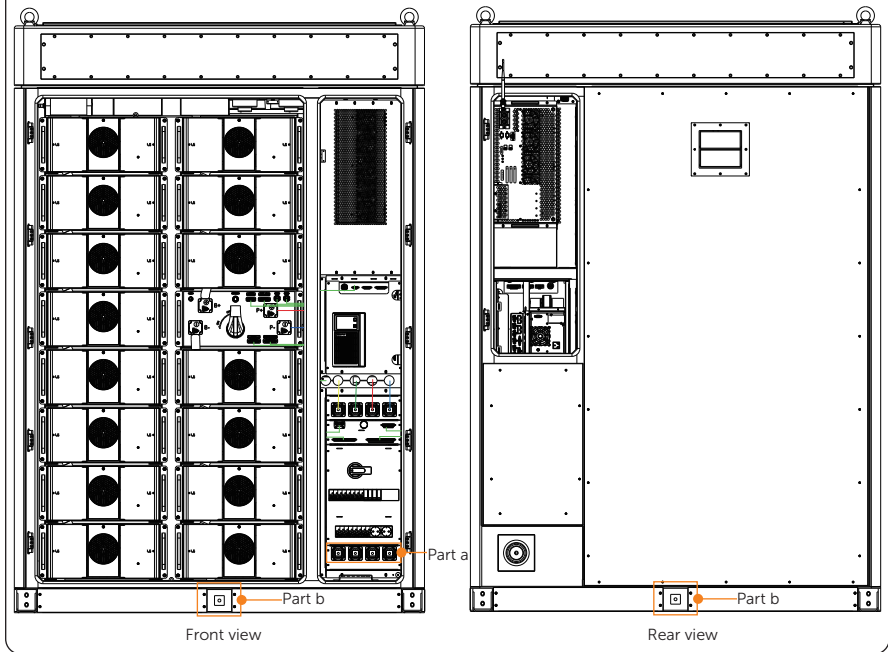

Grid Connection

Regarding the grid connection, namely Part a in [“Parts that Need Wiring”](#), please strictly follow the steps below.

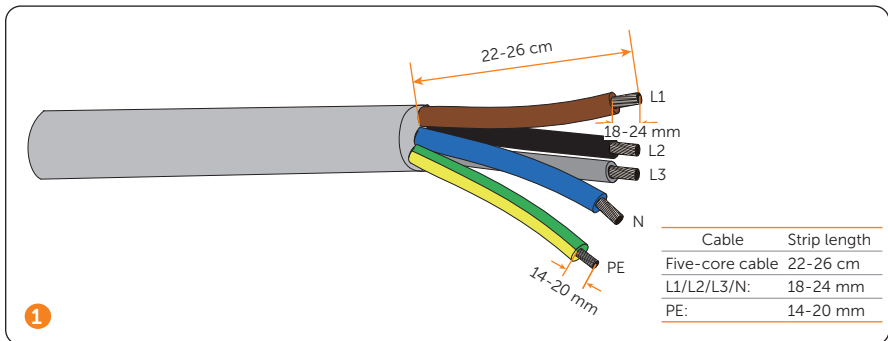

Note!

1. It's important to give the power cable a health check before stripping it.
2. It's necessary to use controlled motion to strip the insulation down the wire, to prevent damage to the wires.
3. Make sure that the insulation layer has been stripped to a sufficient length so that the center conductor is fully exposed without any damage or nicks. In addition, make sure that no extra insulation remains beyond the connector once it's crimped on.

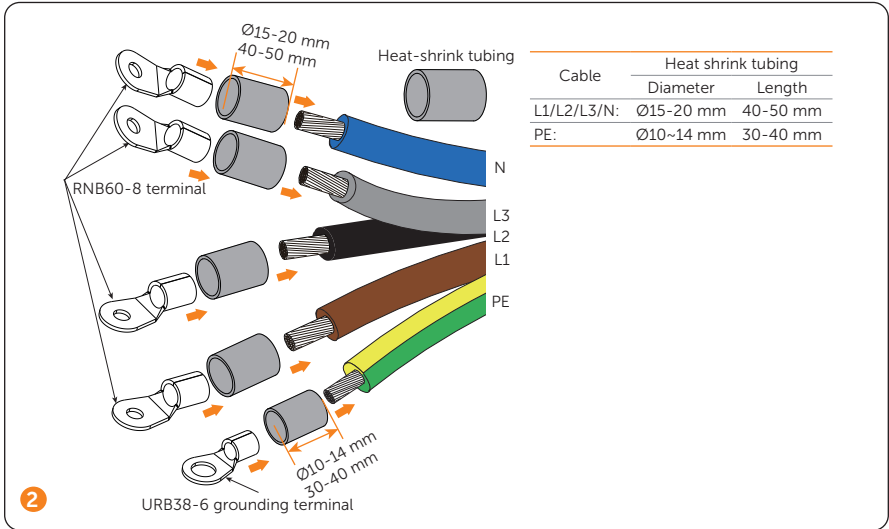

Since the procedure for installing a terminal is the same, the following steps take the L1 wire as an example.

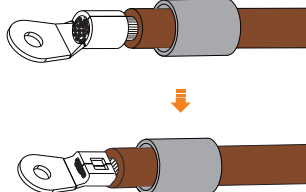

Note!

1. Do not damage the conductor insulation while crimping.
2. Do not place the conductor insulation into the terminal.

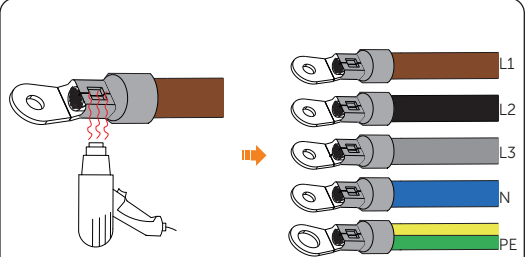

Note!

Move the heat gun back and forth slowly to distribute the heat evenly across the surface of heat shrink tubing.

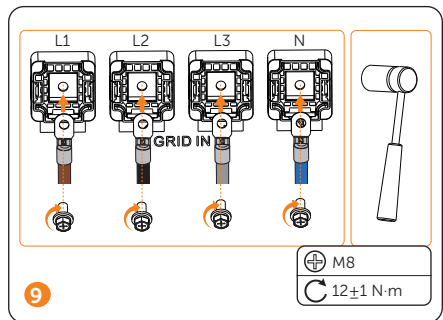
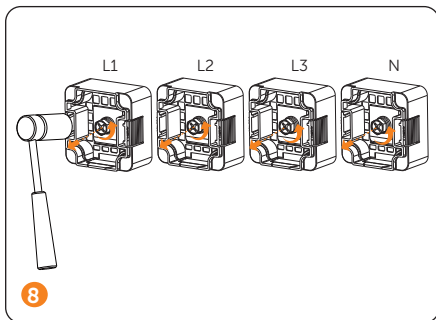
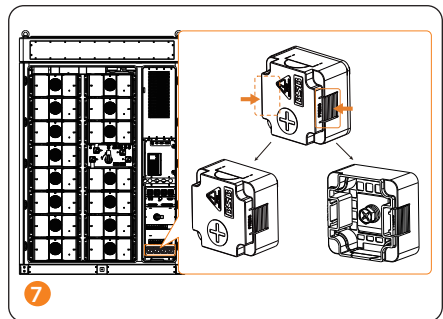
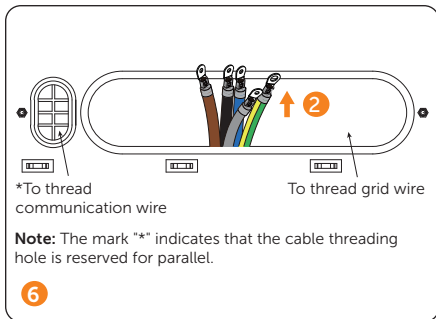
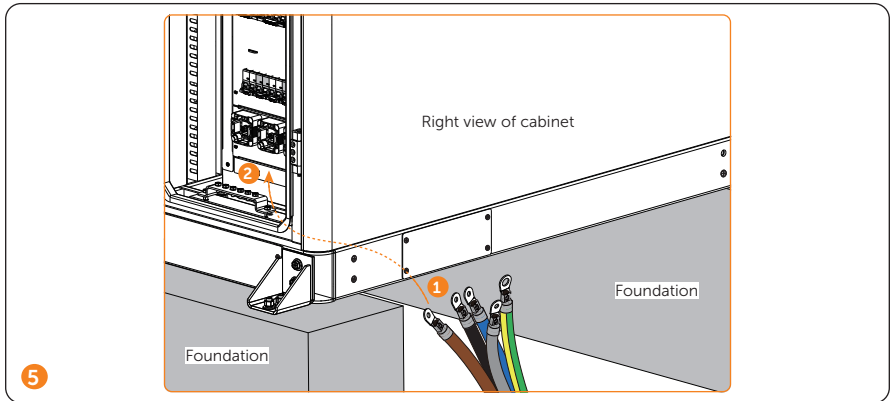

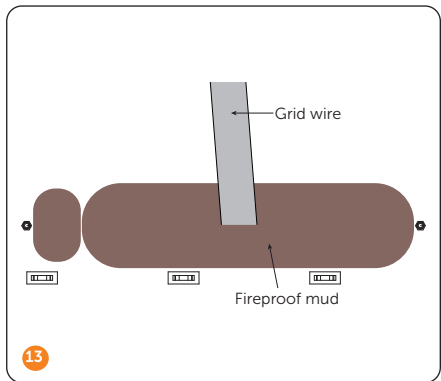
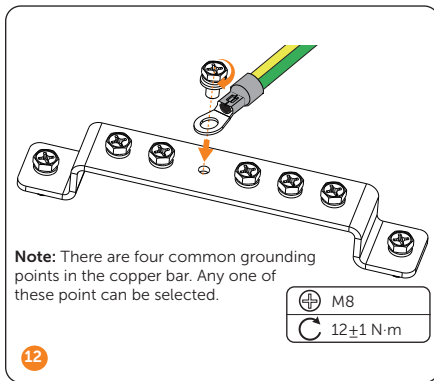
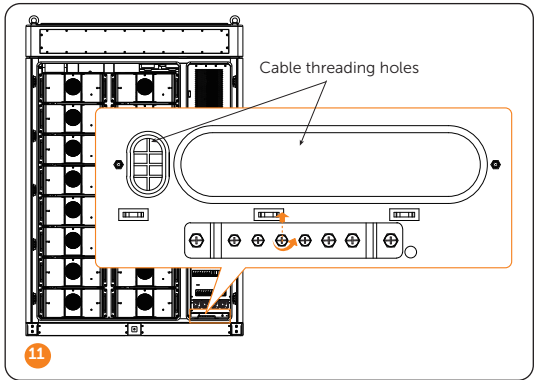
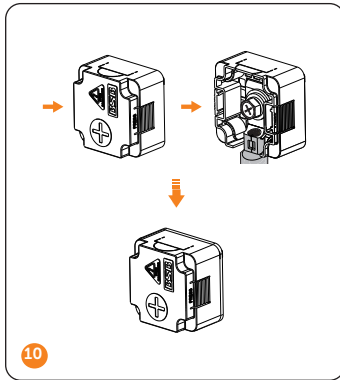

Notice for fireproofing mud:

1. Take out the fireproof mud delivered with the cabinet and knead it into a ball shape. In the case of the low temperature, place it into warm water, of which the temperature range is between 40°C and 70 °C, with its package until it is soft.
2. Clean the area around the cable threading hole before sealing it.
3. The fireproof mud should be evenly spread, embedded, or filled in the cable threading hole. If such a hole is too large, a fireproofing board can be placed to enhance fire protection before using the mud.
4. The fireproof mud needs to be cured after sealing the cable threading hole. Prevent water from entering and colliding during curing.

Grounding Plate Connection

Regarding the grounding plate connection, namely Part b in [“Parts that Need Wiring”](#), either connection area is available, please strictly follow the steps below.

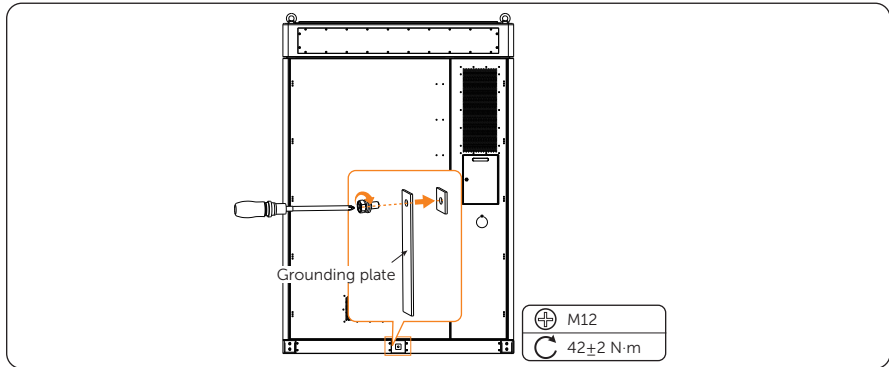

Power on the System / Schalten Sie das System ein / Mise sous tension du système / Encienda el sistema / Ligue o sistema / Het systeem inschakelen / Accensione del sistema / Włączanie systemu / Zapnutí systému / Slå på systemet / Pornire sistem / Включване на системата / Tænd for systemet / Ρεύμα στο σύστημα / Süsteemi sisselülitamine / Kytke järjestelmän virta päälle / Napajanje sustava / Rendszer áram alá helyezés / Įjungti sistemą / Ieslēdziet sistēmu / Zapnite system / Vklopite sistem / Sistemini Gücü / Ligar o sistema

Regarding the detailed location of the modules in the cabinet, see following figure.

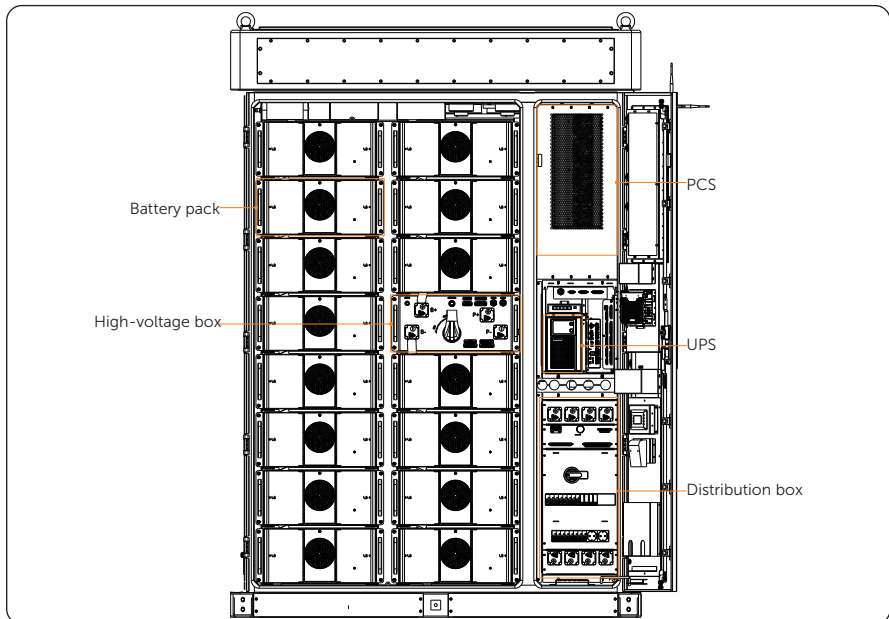

For the detailed steps, see following figures.

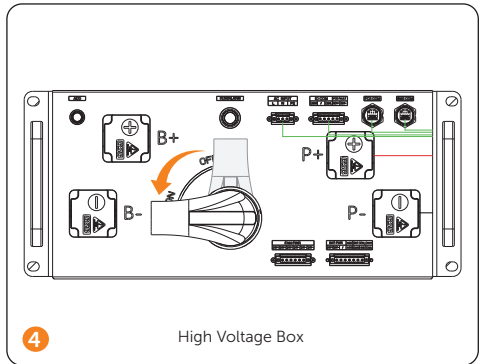
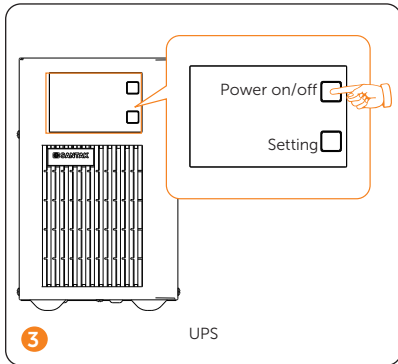
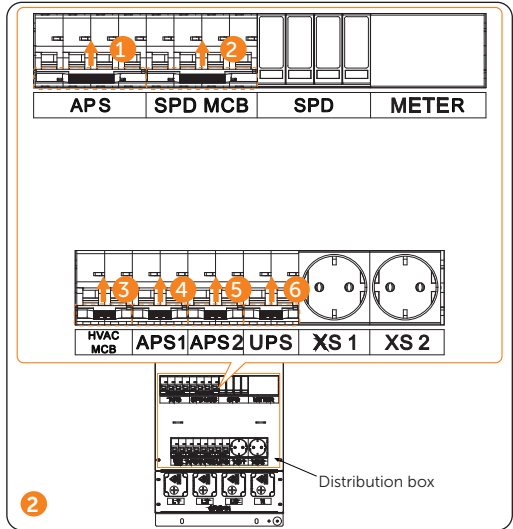
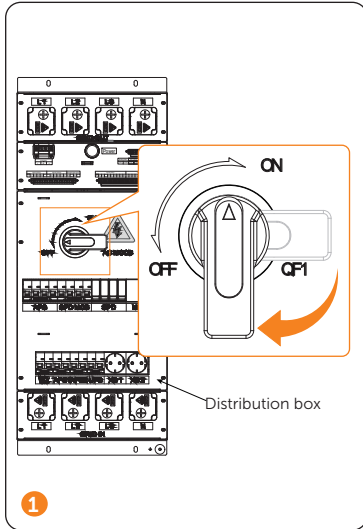

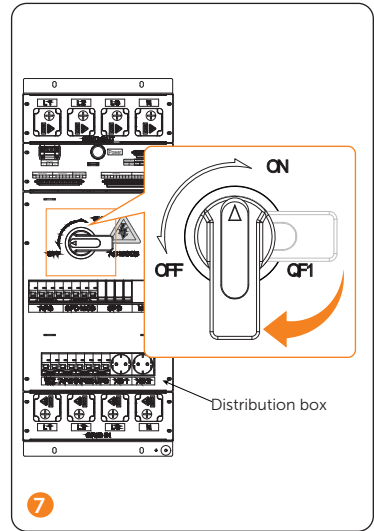
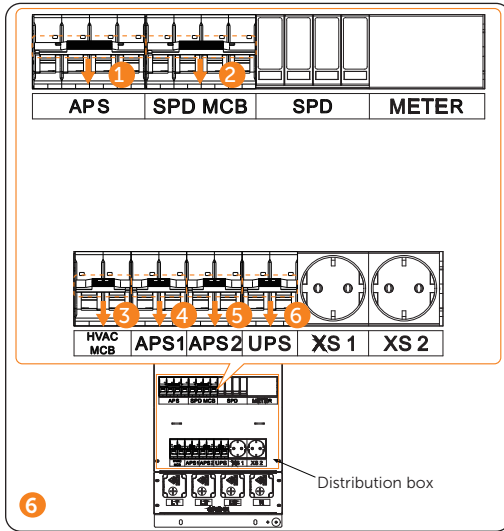
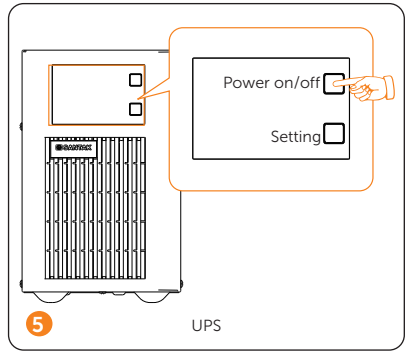
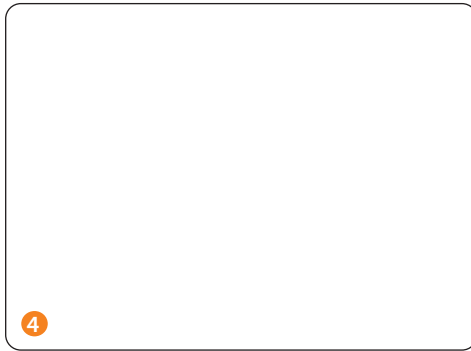

Warning!

The device may still have power and heat after turning off, which may cause electric shock and personal injuries. Therefore, please allow it to cool for at least 5 minutes and wear PPE before conducting maintenance.

Emergency Power Off

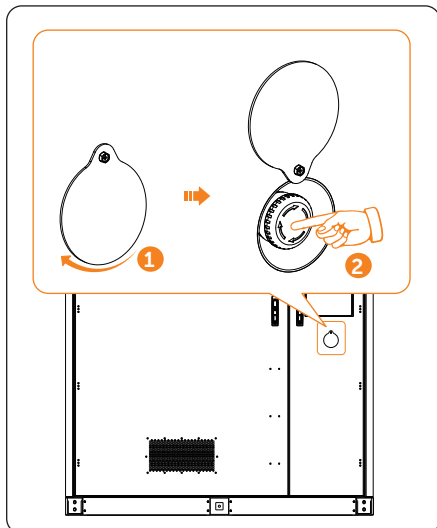

Warning!

Do not press the emergency stop button except for emergencies.

Note!



If it has been pressed, the emergency stop button must be reset before starting the equipment. The reset steps are shown as follows:

1. Rotate the cover;
2. Rotate the button according to the arrow direction shown on the button. Then the button will spring back to its original position.

LED Indicators / LED-Indikatoren / Indicateurs LED / Indicadores LED / Indicadores LED / LED-indicatoren / Indicatori LED / Wskaźniki LED / LED indikátory / LED-indikatorer / Indicatori LED / LED индикатори / LED-indikatorer / Ενδεικτικές λυχνίες LED / LED-indikaatorid / LED-merkkivalot / LED pokazatelji / LED kijelzők / LED indikátoriai / LED indikatori / LED indikátory / LED kazalniki / LED Göstergeleri / Indicadores LED

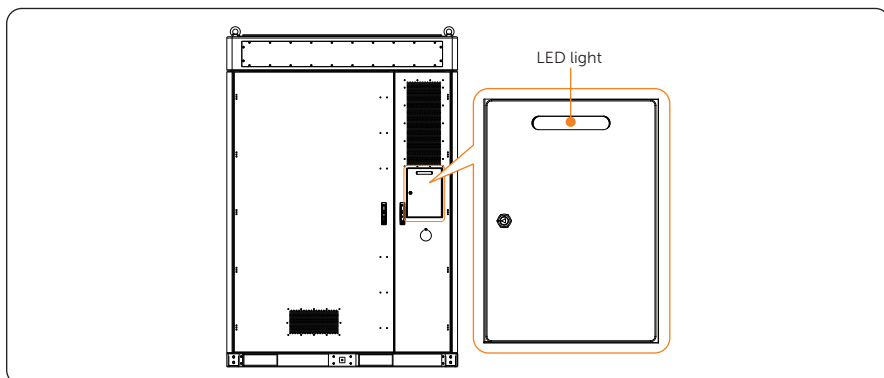

Cabinet's LED Light

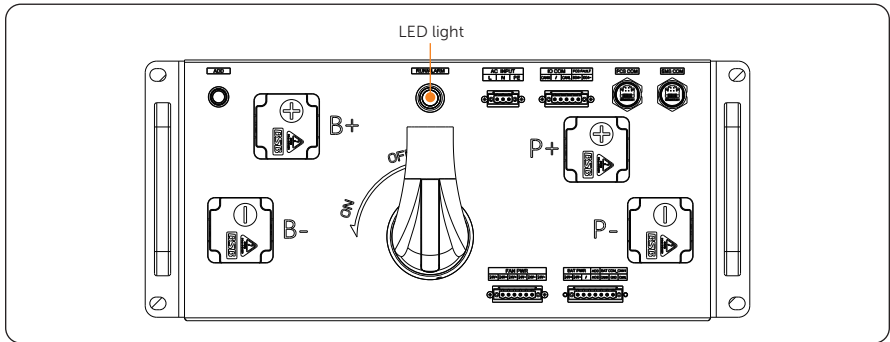

Status	Description
Solid yellow light 	In standby
Solid green light 	In operation
Solid red light 	System failure

High-voltage Box's LED Light



Status	Description
Flashing green light 	Press and hold "power button" ≥ 15 seconds to enter into "operating state". During this period, the system will assign each battery pack in a communication loop a unique address (battery number).
Solid green light 	In operation
Solid red light 	System failure

Battery Pack's LED Light

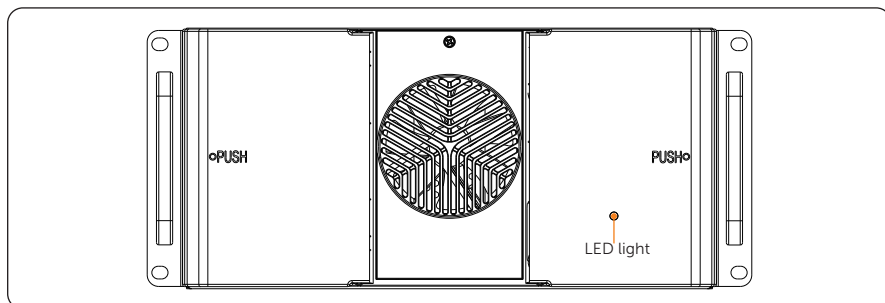

Status

Description

Flashing green light



In operation

Technical Data / Technische Daten / Fiche technique / Datos técnicos / Dados Técnicos / Technische gegevens / Dati tecnici / Dane techniczne / Technické údaje / Tekniska data / Date tehnice / Технически данни / Tekniske data / Τεχνικά δεδομένα / Tehnilised andmed / Tekniset tiedot / Tehnički podaci / Műszaki adatok / Techniniai duomenys / Tehniskie dati / Technické údaje / Tehnični podatki / Teknik Bilgiler / Dados Técnicos

Cabinet (AC Side)

Model	TRENE-P100B215I
Rated AC power [kW]	100
Rated AC current [A]	144.4
Max. AC apparent power [kVA]	110
Nominal grid voltage [V]	400 (-20% ~ +15%)
Nominal grid frequency [Hz]	50/60
Adjustable power factor range	1 (0.8 Leading ~ 0.8 Lagging)
THDi (Rated power) [%]	<3
Max. efficiency [%]	98%

Battery

Model	TRENE-P100B215I
Battery Type	LiFePO4
Battery capacity [kWh]	215
Rated battery voltage [V]	768
Battery voltage range [V]	600 ~ 876
Discharge depth [%]	90
Rated charge/discharge current [A]	140



General Parameter

Model	TRENE-P100B215I
Dimension (W×H×D) [mm]	1680 × 2420 × 1200
Weight [kg]	2800
Operating temperature range [°C]	-30 ~ 55
Relative humidity (Non-condensing) [%]	0 ~ 95
Altitude [m]	3000
Cooling concept	Smart air cooling
Ingress protection	IP55
Fire protection	Aerosol (Optional: Novec1230) / Water
Topology	Non-isolated
Certificates	IEC62619, IEC63056:2000, IEC61000, IEC62477-1, UN38.3, GB/T36276, GB/T34131

Contact Information





UNITED KINGDOM

 Unit C-D Riversdale House, Riversdale Road, Atherstone, CV9 1FA
 +44 (0) 2476 586 998
 service.uk@solaxpower.com





TURKEY

 Fevzi Çakmak mah. asım cd. no 88 A Karatay / Konya / Türkiye
 service.tr@solaxpower.com



USA

 3780 Kilroy Airport Way, Suite 200, Long Beach, CA, US 90806
 +1 (408) 690 9464
 info@solaxpower.com





POLAND

 WARSAW AL. JANA P. II 27. POST
 +48 662 430 292
 service.pl@solaxpower.com



ITALY

 +39 011 19800998
 support@solaxpower.it





PAKISTAN

 service.pk@solaxpower.com







AUSTRALIA

 21 Nicholas Dr, Dandenong South VIC 3175
 +61 1300 476 529
 service@solaxpower.com







GERMANY

 Am Tullnaupark 8, 90402 Nürnberg, Germany
 +49 (0) 6142 4091 664
 service.eu@solaxpower.com
 service.dach@solaxpower.com





NETHERLANDS

 Twekkeler-Es 15 7547 ST Enschede
 +31 (0) 8527 37932
 service.eu@solaxpower.com
 service.bnl@solaxpower.com





SPAIN

 +34 9373 79607
 tecnico@solaxpower.com



BRAZIL

 +55 (34) 9667 0319
 info@solaxpower.com



SOUTH AFRICA

 service.za@solaxpower.com

Warranty Registration Form



For Customer (Compulsory)

Name Country

Phone Number Email

Address

State Zip Code

Product Serial Number

Date of Commissioning

Installation Company Name

Installer Name Electrician License No.

For Installer

Module (If Any)

Module Brand

Module Size(W)

Number of String Number of Panel Per String

Battery (If Any)

Battery Type

Brand

Number of Battery Attached

Date of Delivery Signature

Please visit our warranty website: <https://www.solaxcloud.com/#/warranty> or use your mobile phone to scan the QR code to complete the online warranty registration.



For more detailed warranty terms, please visit SolaX official website: www.solaxpower.com to check it.





SolaX Power Network Technology (Zhejiang) Co., Ltd.

ADD.: No. 278, Shizhu Road, Chengnan Sub-district, Tonglu County,
Hangzhou, Zhejiang, China

E-mail: info@solaxpower.com

www.solaxpower.com